



# CATALOGO BRT ATTREZZATURE 2024



## Asso di Coppe

◀ VESTE E PREMIA LO SPORT ▶

Richiedi un preventivo **GRATUITO** per portarti a conoscenza dello **SCONTO RISERVATO**  
Per le vostre esigenze diverse vi preghiamo di visitare i siti  
[www.assodicoppe.it](http://www.assodicoppe.it) - [info@assodicoppe.it](mailto:info@assodicoppe.it)

## INDICE ALFABETICO

Archi di precisione - Precision Arcs .....	pag. 39
Arredi spogliatoio ed infermeria - Locker and infirmary room .....	pag. 156-161
Arti Marziali, Boxe - Martial Arts, Boxing .....	pag. 202-203;205; 209
Atletica - Track and Field .....	pag. 215-218
Attrezzi speciali, Scalette e Bande elastiche - Special Training tools, Speed Ladders and Elastic Bands .....	pag. 63-79
Badminton.....	pag. 200
Bandierine e accessori per arbitro - Flags and referee's accessories.....	pag. 108-111
Barriera filtrante, Barriera con finestre - Reflex Training Device, Window Barrier.....	pag. 42
Basket .....	pag. 165-172
Beach Soccer .....	pag. 163
Beach Volley .....	pag. 180-181
Borse - Bags.....	pag. 124-125
Casacche, Pantaloncini, Calze, Giacche Antipioggia, Tubolare Barret .....	pag. 89-91
Ceste Portapalloni - Baskets for balls .....	pag. 126
Cross Training, Reti con bersagli - Cross Training, Nets with targets.....	pag. 141-142
Delimitatori e Birilli - Markers and Cones .....	pag. 21-25
Deviatori di traiettoria, Ball Playning - Deviators, Ball Playning .....	pag. 52-54
Fitness Equipment.....	pag. 81-88
Forche - Heading Trellises.....	pag. 40-41
Ghiaccio, Tape, Creme, Oli - Ice, Tape, Creams, Oils.....	pag. 104-105
Ginnastica - Gymnastic .....	pag. 210-214
Hockey, Baseball .....	pag. 201;204
Impianti Multifunzione - Multi purpose systems .....	pag. 184
Kit Calcio Tennis - Soccer Tennis kits.....	pag. 36-38
Kit tecnico Scuola Calcio - Soccer School kit.....	pag. 80
Lavagne Tattiche - Tactical Boards.....	pag. 100-103
Materassi, Protezioni Murarie - Mats, Wall Protections.....	pag. 206-208
Materassini, Borracce - Mats, Water Bottles .....	pag. 99;106-107
Minivolley, Superminivolley .....	pag. 179
Muri e Telai con rete - Rebounders and Iron Frames with net .....	pag. 43-51
Numeri Termosaldabili .....	pag. 98
Ostacoli ad altezza fissa e regolabile - Hurdles fixed and adjustable heights.....	pag. 26-35
Paletti Slalom - Slalom Poles.....	pag. 18-20
Pallamano - Handball .....	pag. 185
Palle Mediche, Ritmiche e Psicomotorie - Medicine, Rhythmic and Gym Balls.....	pag. 120-123
Palloni in pelle ed in gomma - Leather and rubber Balls .....	pag. 116-119
Panchine Allenatori - Trainers' Dug-outs.....	pag. 143-149
Parastinchi, Fasce Capitano, Guanti Portiere - Shinguards, Captain Armbands, GK Gloves .....	pag. 96-97
Pilates, Didattica Scolastica, Pattini e Skateboard - Pilates, School Products, Skates .....	pag. 219-222
Piscina, Pallanuoto - Swimming Pool, Waterpolo .....	pag. 197-199
Pompe, Compressore, Cronometri e Rotelle Metriche - Pumps, Inflator, Chronometers, Measuring Tapes .....	pag. 114-115
Porte regolamentari, ridotte, miniporte, porte bifrontali - Official goals, reduced goals, minigoals, 2 side goals.....	pag. 127-136
Protezioni personali - Protections .....	pag. 182-183
Reti di Protezione - Protection Nets.....	pag. 140
Reti regolamentari e ridotte - Nets all sizes.....	pag. 137-139
Rugby.....	pag. 195-196
Sagome e Barriere - Mannequins and Barriers.....	pag. 6-17
Sedute per gradinate e Tribune modulari per interno ed esterno - Stadium seats and Stands .....	pag. 153-155
Segnalatori manuali ed elettronici per cambio giocatori - Substitution Boards .....	pag. 112-113
Strutture instabili e Tavole Propriocettive, Plinti - Equilibrium Boards.....	pag. 55-61
Tabelloni elettronici segnapunti - Electronic scoreboards.....	pag. 186-188
Tacchetti ed accessori per scarpe, Lavascarpe - Studs and shoe accessories, Shoe Washing Device.....	pag. 92-95
Tavoli calcetto - Soccer tables .....	pag. 164
Tennis Tavolo - Table Tennis .....	pag. 192-194
Tennis, Beach Tennis, Padel .....	pag. 189-191
Trampolini - Trampolines .....	pag. 62
Tunnel uscita spogliatoi - Stadium Tunnels.....	pag. 162
Vernice Segnacampo, Carrelli Traccialinee - Ecological Paint, Line Markers.....	pag. 150-152
Volley .....	pag. 173-178

INDICE - INDEX

**Attrezzature per la preparazione atletica e specifiche per il Calcio**  
**Training and Soccer equipment**

Sagome e Barriere - Mannequins and Barriers .....	pag.	6-17
Barriera filtrante, Barriera con finestre - Reflex Training Device, Window Barrier .....	pag.	42
Paletti Slalom - Slalom Poles .....	pag.	18-20
Delimitatori e Birilli - Markers and Cones .....	pag.	21-25
Ostacoli ad altezza fissa e regolabile - Hurdles fixed and adjustable heights .....	pag.	26-35
Kit Calcio Tennis - Soccer Tennis kits .....	pag.	36-38
Forche - Heading Trellises .....	pag.	40-41
Archi di precisione - Precision Arcs .....	pag.	39
Muri e Telai con rete - Rebounders and Iron Frames with net .....	pag.	43-51
Devianti di traiettoria, Ball Playning - Deviators, Ball Playning .....	pag.	52-54
Cross Training, Reti con bersagli - Cross Training, Nets with targets .....	pag.	141-142
Strutture instabili e Tavole Propriocettive, Plinti - Equilibrium Boards .....	pag.	55-61
Trampolini - Trampolines .....	pag.	62
Attrezzi speciali, Scalette e Bande elastiche - Special Training tools, Speed Ladders and Elastic Bands .....	pag.	63-79
Kit tecnico Scuola Calcio - Soccer School kit .....	pag.	80
Fitness Equipment .....	pag.	81-88
Casacche, Pantaloncini, Calze, Giacche Antipioggia, Tubolare Barret, Numeri Termosaldabili - Mesh Shirts, Shorts, Socks, Rain jackets, Tubular hat, Numbers for uniforms .....	pag.	89-91;98
Tacchetti ed accessori per scarpe, Lavascarpe - Studs and shoe accessories, Shoe Washing Device .....	pag.	92-95
Parastinchi, Fasce Capitano, Guanti Portiere - Shinguards, Captain Armbands, GK Gloves .....	pag.	96-97
Lavagne Tattiche - Tactical Boards .....	pag.	100-103
Ghiaccio, Tape, Creme, Oli - Ice, Tape, Creams, Oils .....	pag.	104-105
Materassini, Borracce - Mats, Water Bottles .....	pag.	99;106-107
Bandierine e accessori per arbitro - Flags and referee's accessories .....	pag.	108-111
Pompe, Compressore, Cronometri e Rotelle Metriche - Pumps, Inflator, Chronometers, Measuring Tapes .....	pag.	114-115
Segnalatori manuali ed elettronici per cambio giocatori - Substitution Boards .....	pag.	112-113
Palloni in pelle ed in gomma - Leather and rubber Balls .....	pag.	116-119
Palle Mediche, Ritmiche e Psicomotorie - Medicine, Rhythmic and Gym Balls .....	pag.	120-123
Ceste Portapalloni - Baskets for balls .....	pag.	126
Borse - Bags .....	pag.	124-125
Protezioni personali - Protections .....	pag.	182-183

**Attrezzature per lo stadio e lo spogliatoio**  
**Stadium and locker room equipment**

Porte regolamentari, ridotte, miniporte, porte bifrontali - Official goals, reduced goals, minigoals, 2 side goals .	pag.	127-136
Reti regolamentari e ridotte - Nets all sizes .....	pag.	137-139
Reti di Protezione - Protection Nets .....	pag.	140
Panchine Allenatori - Trainers' Dug-outs .....	pag.	143-149
Vernice Segnacampo, Carrelli Traccialinee - Ecological Paint, Line Markers .....	pag.	150-152
Sedute per gradinate e Tribune modulari per interno ed esterno - Stadium seats and Stands .....	pag.	153-155
Arredi spogliatoio ed infermeria - Locker and infirmary room .....	pag.	156-161
Tunnel uscita spogliatoi - Stadium Tunnels .....	pag.	162
Tabelloni elettronici segnapunti - Electronic scoreboards .....	pag.	186-188
Materassi, Protezioni Murarie - Mats, Wall Protections .....	pag.	206-208

**Altri sport - other sports**

Tavoli calcetto - Soccer tables .....	pag.	164
Basket .....	pag.	165-172
Volley .....	pag.	173-178
Minivolley, Superminivolley .....	pag.	179
Beach Volley .....	pag.	180-181
Beach Soccer .....	pag.	163
Impianti Multifunzione - Multi purpose systems .....	pag.	184
Pallamano - Handball .....	pag.	185
Tennis, Beach Tennis, Padel .....	pag.	189-191
Tennis Tavolo - Table Tennis .....	pag.	192-194
Badminton .....	pag.	200
Rugby .....	pag.	195-196
Piscina, Pallanuoto - Swimming Pool, Waterpolo .....	pag.	197-199
Hockey, Baseball .....	pag.	201;204
Arti Marziali, Boxe - Martial Arts, Boxing .....	pag.	202-203;205;209
Ginnastica - Gymnastic .....	pag.	210-214
Atletica - Track and Field .....	pag.	215-218
Pilates, Didattica Scolastica, Pattini e Skateboard - Pilates, School Products, Skates .....	pag.	219-222



Allenamento 28/09/2018 - Training session 24/09/2018



**Allenamento 12/03/2019 - Training session 12/03/2019**



**Allenamento 12/03/2019 - Training session 12/03/2019**



## NUOVI PRODOTTI - NEW PRODUCTS



### Art. 239TI

Ostacolo con traversa inclinata altezza variabile da cm. 12 a cm. 60 in ferro verniciato - larghezza mt. 2 (scomponibile) **Ordinare quantità multipla di 3 pezzi**

Hurdle with inclined crossbar height from 12 cm. to 60 cm. in painted iron - width 2 meters (dismountable in 3 pieces) **Please order multiple quantities of 3 pieces**



Pag. 133

### Art. 500SG

Porta m. 3x2 trasportabile in ferro verniciato, tubo sezione mm. 50 completa di rete, ganci e picchetti

3x2 meter transportable Goal in painted iron, pipe section 50 mm. complete with net and anchor pegs



Pag. 136

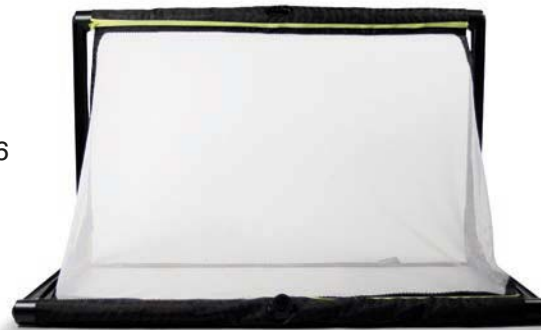

### Art. BG150

Miniporta cm.150x90 pieghevole in PVC con rete personalizzabile (si installa in 10 secondi e si trasporta facilmente)

Foldable 150x90 cm. mini-goal in PVC with customizable net (ready in 10 seconds and very easy to transport)



**Art. SKN05 / SKN1 / SKN2 / SKN3 / SKN4 / SKN5**

**Palle mediche SKIN BALL riempite con acqua demineralizzata colorata - peso kg. 0,5-1-2-3-4-5**  
 SKIN BALL Medicine balls filled with demineralized coloured water - weight 0,5-1-2-3-4-5 Kg.



**Art. BOS**

**Pedana BOSU Ø cm.59 - h. cm.26**  
**ideale per fitness, yoga, pilates**  
**completa di elastici con maniglie e pompa**  
 Bosu ball Ø 59 cm. - h. 26 cm.  
 ideal for fitness, yoga, pilates  
 complete with rubber bands with handles and pump



**Art. MGED6 / MGED8 / MGED10**

**Manubrio esagonale con rivestimento in gomma Kg. 6-8-10**  
**(fornito singolarmente)**  
 Hexagonal Dumb Bell with rubber coating 6-8-10 Kg.





pg.1

**NUOVO MATERIALE PIÙ FLESSIBILE  
NEW MORE ELASTIC PLASTIC MATERIAL**



**Art. 001**  
**Sagoma Barret brevettata**  
**cm. 180 Kg. 3,5**  
Patented Barret Mannequin  
cm. 180 Kg. 3,5

**Art. 002**  
**Sagoma Barret brevettata**  
**cm. 160 Kg. 3**  
Patented Barret Mannequin  
cm. 160 Kg. 3

Colori:  
Rosso, Blu e Giallo  
Colors:  
Red, Blue and Yellow

**SAGOME BARRET BREVETTATE**  
leggere, flessibili, super-resistenti,  
antifortunistiche!

**PATENTED BARRET MANNEQUINS**  
light, flexible, strong, safe!

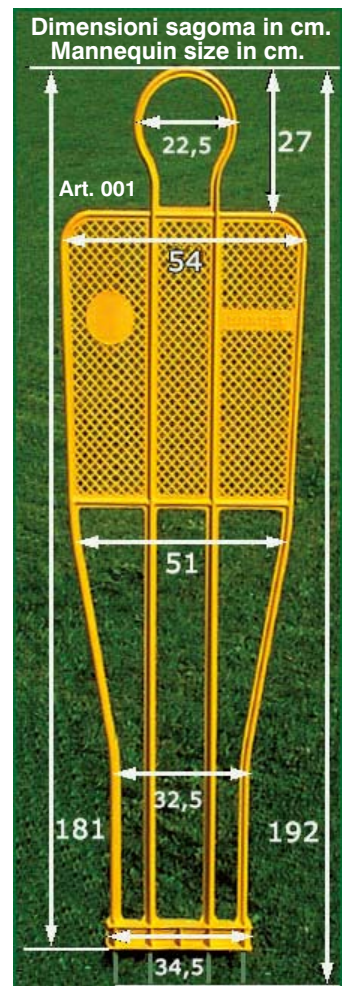

## SAGOME E BARRIERE - Barriers



**Art. 003** Carrello porta 5 sagome in acciaio zincato con ruote  
Trolley for carrying 5 mannequins in galvanized steel, with wheels

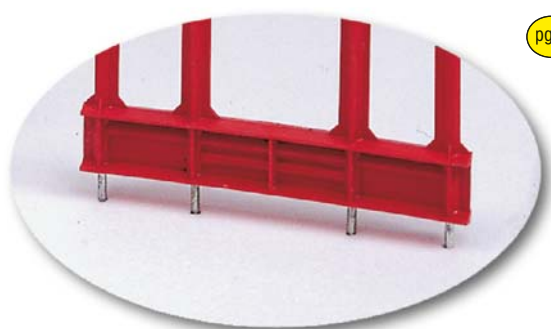

**4 puntali in acciaio zincato alla base  
per posizionamento su  
terreno naturale  
o su carrello porta sagome**  
4 galvanized steel spikes at the base,  
for easy positioning on natural grass  
or upon Barret trolley

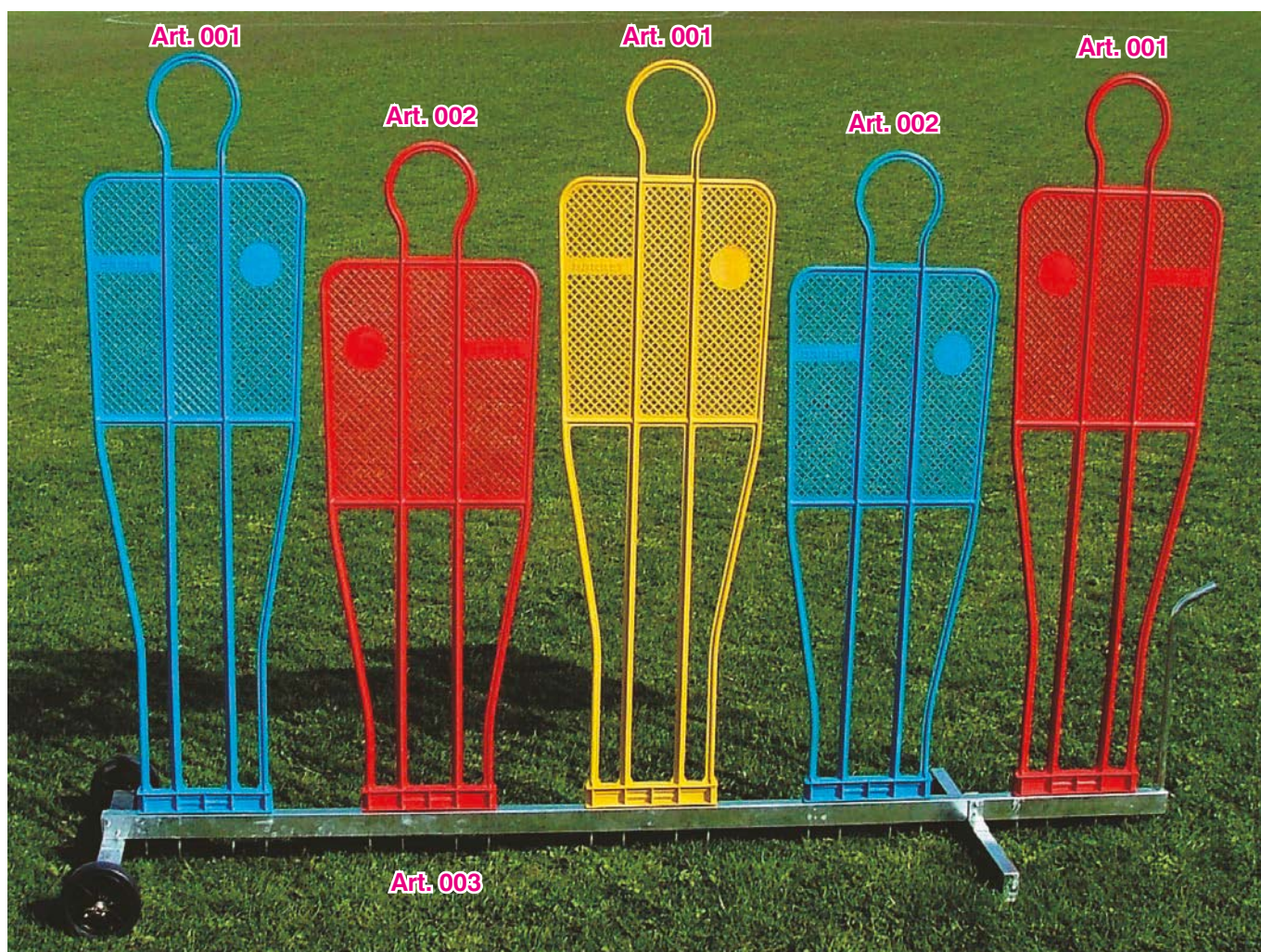

**3 x Art. 001 + 2 x Art. 002 + Art. 003**

**SAGOME BARRET BREVETTATE**

indispensabili per:  
*calci di punizione, slalom, dribbling,  
esercizi di anticipo, uscite aeree,  
schemi tattici ...*

**PATENTED BARRET MANNEQUINS**

very useful for:  
*free kicks, slalom, dribbling, tackles,  
headers, goalkeeper exercises, tactics ...*

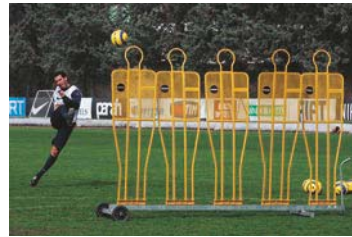

pg.1

Video dimostrativo  
disponibile  
su [www.barretsport.com](http://www.barretsport.com)  
Video available on  
[www.barretsport.com](http://www.barretsport.com)



**Art. 003RG**

**Carrello porta 5 sagome in acciaio zincato con ruote - regolabile a 4 altezze (la sagoma Art. 001 può arrivare ad un'altezza massima da terra di cm.225)**  
Trolley for 5 mannequins in galvanized steel, with wheels - 4 adjustable heights  
(Art. 001 can reach up to 225 cm. height)

**Il carrello regolabile in altezza permette di simulare la presenza di giocatori in barriera che saltano al momento del calcio di punizione**  
This trolley allows free kick practicing by simulating jumping defenders

pg.1



**3 x Art. 001 + 2 x Art. 002 + Art. 003RG**



**Art. BPS001**

**Borsa porta 5 sagome in nylon impermeabile con tracolla e maniglie, rinforzi laterali in polipropilene rigido**  
Nylon carrying bag for 5 mannequins with shoulder belt and handles waterproof - reinforced on both sides



Art. 001  
+ Art. 003S

**Art. 003S Carrello porta sagoma in acciaio zincato con ruote, con molle antibaltamento**  
Trolley for single mannequin in galvanized steel with springs, on wheels

pg.1

**Grazie alle molle il carrello Art. 003S impedisce alla sagoma di cadere a terra se colpita dalla palla**  
Thanks to the springs trolley Art. 003S allows mannequin to come back straight up when hit by the ball



Art. 003S



Art. 001B



Art. 001  
+ Art. 001B

**Art. 001B**  
Base per sagoma zavorrabile in acciaio zincato, per posizionamento su terreni sintetici

**Peso:**  
kg. 10 vuota,  
kg. 20 riempita con sabbia  
Galvanized steel base to be filled with sand for mannequin positioning on artificial grass.  
Weight: 10 kg. empty  
20 kg. filled with sand



Art. 002R

Art. 001R

**Art. 001R**  
Rivestimento per Sagoma cm. 180 in nylon impermeabile antistrappo con cerniera  
Colori: rosso, blu, giallo  
Nylon Cover for cm. 180 Mannequin with zip  
Colors: red, blue, yellow

**Art. 002R**  
Rivestimento per Sagoma cm. 160 in nylon impermeabile antistrappo con cerniera  
Colori: rosso, blu, giallo  
Nylon Cover for cm. 160 Mannequin with zip  
Colors: red, blue, yellow



5 x Art. 001 + 5 x Art. 001R



5 x Art. 001 + 5 x Art. 001R  
+ Art. 003RG



LATO POSTERIORE  
BACK SIDE



Art. 001FE

**Art. 001FE**  
**Sagoma Barret**  
**in acciaio zincato**  
**con 4 puntali**  
**altezza cm.180**  
**peso kg.5**  
 Barret mannequin  
 180 cm. height  
 in galvanized steel  
 with 4 spikes  
 weight 5 Kg.



Art. 001FE  
 + Art. 001B



Art. 001FE  
 + Art. 001R  
 + Art. 001B

pg.1



Art. 002FE

**Sagoma Barret in acciaio**  
**zincato con 4 puntali**  
**altezza cm.160**  
**peso kg.4,5**

Barret mannequin  
 160 cm.  
 height in galvanized steel with  
 4 spikes weight 4,5 Kg.



3 x Art. 001FE + 2 x Art. 001R  
 2 x Art. 002FE + 2 x Art. 002R  
 + Art. 003



**Art. 001TD Rivestimento tridimensionale per sagoma Art. 001**  
h. cm. 180 spessore cm. 20  
in PVC bispalmato 600 gr/mq  
imbottitura in gommapiuma d. 16 kg/mc  
3D Cover 20 cm. thick  
for mannequin Art. 001  
180 cm. height

**I rivestimenti tridimensionali simulano perfettamente il volume del corpo dei giocatori permettendo una serie di esercizi tecnici e tattici con e senza palla ancora più realistici e sicuri. L'imbottitura è inoltre utile per proteggere la sagoma dagli urti della palla calciata ad alta velocità durante l'allenamento ai calci piazzati di potenza**



**3D Covers perfectly resemble players' bodies allowing even more realistic and safe technical and tactical exercises with and without ball.**

**The soft sandwich protections also avoid possible damages caused by high power free kick practising**



● pg.1

**Art. 002TD Rivestimento tridimensionale per sagoma Art. 002**  
h. cm. 160  
spessore cm. 20  
in PVC bispalmato  
600 gr/mq  
imbottitura in gommapiuma  
d. 16 kg/mc  
3D Cover 20 cm. thick  
for mannequin Art. 002  
160 cm. height



**Art. GP170**

Sagoma in gommapiuma  
h. cm. 170 - rivestimento in PVC  
con decorazione digitale  
fronte-retro del giocatore,  
zavorrata alla base con sabbia  
con maniglie per il trasporto  
colori disponibili: rosso, blu,  
giallo, arancio, bianco  
Ø base cm. 59 - peso kg. 31  
Foam rubber Dummy  
170 cm. height with PVC Cover  
with player's sketch  
weighted base with sand  
with handles  
available colors: red, blue,  
yellow, orange, white  
base Ø 59 cm. - weight 31 kg.

**Nessun problema di  
forature, perdite d'aria  
o lacerazioni**  
No problems with  
punctures, deflation or  
lacerations



← **Rivestimento in PVC**  
PVC Cover outside

← **Imbottitura in  
poliuretano espanso**  
Foam rubber inside

pg.1

**Art. GP205**

Sagoma in gommapiuma  
h. cm. 205 - rivestimento in PVC  
con decorazione digitale  
fronte-retro del giocatore,  
zavorrata alla base con sabbia  
con maniglie per il trasporto  
colori disponibili: rosso, blu,  
giallo, arancio, bianco  
Ø base cm. 59 - peso kg. 32  
Foam rubber Dummy  
205 cm. height with PVC Cover  
with player's sketch  
weighted base with sand  
with handles  
available colors: red, blue,  
yellow, orange, white  
base Ø 59 cm. - weight 32 kg.

← **Maniglia  
su entrambi i lati**  
Handle on both  
sides

← **Base zavorrata**  
Weighted base

**Art. GP170SL**  
Sagoma in  
gommapiuma  
come Art. GP170  
solo con logo  
BARRET (senza  
la decorazione  
del giocatore)  
Foam rubber  
Dummy same of  
Art. GP170  
only with BARRET  
logo (without  
player's sketch)



**Art. GP205SL**  
Sagoma in  
gommapiuma  
come Art. GP205  
solo con logo  
BARRET (senza  
la decorazione  
del giocatore)  
Foam rubber  
Dummy same of  
Art. GP205  
only with BARRET  
logo (without  
player's sketch)



**Art. SAG205**  
**Sagoma Gonfiabile**  
**h.cm.205**  
Inflatable dummy  
205 cm. height

**SEMPRE IN PIEDI**  
**POP UP DUMMIES**

**NUOVO PVC/PU ANCORA**  
**PIÙ RESISTENTE**  
**NEW STRONGER PVC/PU**



pg.1

**Art. SAG175**  
**Sagoma Gonfiabile h.cm.175**  
Inflatable dummy  
175 cm. height



**Art. SAG115**  
**Sagoma Gonfiabile h.cm.115**  
Inflatable dummy 115 cm. height

**Ideale per i bambini**  
**delle scuole calcio**  
**best for soccer school kids**



Ø base cm. 56 - peso kg. 23  
(pronta all'uso)  
base Ø 56 cm. - weight 23 Kg.  
(when ready for use)

Ø base cm. 45 - peso kg. 11  
(pronta all'uso)  
base Ø 45 cm. - weight 11 Kg.  
(when ready for use)

Ø base cm. 40 - peso kg. 7  
(pronta all'uso)  
base Ø 40 cm. - weight 7 Kg.  
(when ready for use)

**Art. KSG Kit di riparazione per sagoma gonfiabile**  
**(n. 1 confezione di collante + n. 3 porzioni di rivestimento)**  
Repairing Kit for inflatable dummies (glue and 3 patches)

**Per un ordine minimo di 100 pezzi per misura le sagome gonfiabili possono essere personalizzate**  
Inflatable dummies can be customized: minimum order 100 pieces for each size

**Se colpite dalla palla o dal corpo dei giocatori durante gli esercizi, le sagome gonfiabili Barret tornano in piedi da sole**

Barret inflatable dummies always pop back up when hit by ball or players' body during exercises

**Nate per l'allenamento dei portieri, le sagome gonfiabili Barret possono essere utilizzate anche per i calciatori per l'effettuazione di una molteplicità di esercizi tecnici e tattici con e senza palla**

Born for GK training, Barret inflatable dummies are very useful for lots of tactical and technical exercises involving players with and without ball



**Particolare della valvola superiore (rientrante) da utilizzare per la gonfiatura della sagoma e della valvola inferiore (anch'essa rientrante) da utilizzare per il riempimento della base di appoggio a terra con acqua**  
The upper valve to inflate the body with air, the bottom valve to fill the base with water

## ISTRUZIONI PER LA GONFIATURA E L'UTILIZZO DELLE SAGOME GONFIABILI

**IMPORTANTE: LA SAGOMA NON DEVE MAI ESSERE COMPLETAMENTE GONFIA. IL CORPO DEVE RIMANERE SEMPRE MORBIDO, ED I FIANCHI NON DEVONO ESSERE MARCATAMENTE SPORGENTI VERSO L'ESTERNO RISPETTO ALLA BASE**

**(UNA ECCESSIVA QUANTITÀ D'ARIA LOGORA LE SALDATURE ED ACCORCIA LA VITA DEL PRODOTTO)**

- 1) Gonfiare la sagoma solo moderatamente
- 2) Tenendo la sagoma distesa a terra, inserire acqua nel serbatoio: quando la sagoma comincia ad inclinarsi verso l'alto, chiudere il tappo del serbatoio e disporla in posizione verticale
- 3) Provare a spingere la sagoma lateralmente e osservare come torna in posizione eretta
- 4) Se si vuole che la sagoma si rialzi più velocemente, aggiungere dell'acqua (a discapito del peso) e gonfiare un po'
- 5) Se si gonfia ulteriormente la sagoma, distenderla a terra e fare uscire l'aria in eccesso dal serbatoio dell'acqua (il fondo deve essere piatto, non bombato)
- 6) E' importante **utilizzare la minima quantità di acqua** che permette alla sagoma di risalire nel modo desiderato (un peso eccessivo e non giustificato può logorare inutilmente le saldature, accorciando la vita del prodotto)
- 7) Una volta trovato l'equilibrio desiderato, la sagoma può essere sgonfiata e rigonfiata (ad esempio, per trasportarla in luogo lontano) senza più svuotare il serbatoio dell'acqua
- 8) Non utilizzare le sagome se la temperatura è più bassa di 5 °C (e in ogni caso non usarle se l'acqua nel serbatoio è ghiacciata)
- 9) Non colpire le sagome con corpi appuntiti, non avvicinarle a fonti di calore, non trascinarle ma sollevarle sempre con le maniglie quando occorre spostarle, non sbatterle violentemente a terra, non lasciarle esposte al sole per giorni
- 10) Per le riparazioni utilizzare l'apposito kit o Loctite 406 (altri prodotti non hanno efficacia sul materiale) Il prodotto è garantito solo per un utilizzo diligente che rispetti le istruzioni fornite



**Art. KSG**  
Kit di riparazione  
(collante +  
3 porzioni di  
rivestimento)  
Inflatable dummy  
repairing kit



**SEMPRE IN PIEDI  
POP UP DUMMIES**



### USER'S INSTRUCTIONS

**IMPORTANT: YOU ALWAYS HAVE TO KEEP THE BODY OF YOUR DUMMY VERY SOFT (NOT FULLY INFLATED) AND HIPS HAVE TO BE IN A STRAIGHT LINE WITH THE BASE (THEY MUST NOT BE ROUNDED).**

**AN EXCESSIVE AMOUNT OF AIR WILL WEAR OUT THE WELDS AND SHORTEN THE TOOL'S LIFE**

Inflatable dummies are entirely made of soft PVC/PU: there are no rigid parts, so these products are absolutely safe. First, you have to inflate your dummy but not completely. Then, by keeping it lying on the floor, you have to put some water in the tank: when the dummy rises up, close the valve and place it upright.

If you want your dummy to rise up more quickly when hit, add some water and inflate the body a little more. In this case, let the dummy lie on the floor for a while and let some air out from the tank (the base must be flat, not rounded). It's important you **to use the minimum amount of water** that allows your dummy to rise the desired way (an excessive and unjustified weight will wear out the welds, shortening the tool's life).

Once the desired balance has been found, the dummy can be deflated and re-inflated without emptying the water tank (for example, when you need to transport it to a distant place).

Dummies can be used both on natural and artificial grass, on turf, gym floors etc.

Two side handles made of soft PVC are very useful to carry your dummy around: it is important to always lift your dummy when you need to move it (never pull it!) so the base doesn't get damaged.

Do not use dummies if the temperature is lower than 5 °C (and in any case do not use them if the water in the tank is frozen).

It is also available a kit for repair when inflatable dummies get damaged because used in wrong ways, in example when they are torn apart by players kicking with their studs against them.



pg.1

**Art. 706244**  
**Sagoma in plastica rinforzata antiurto**  
**su carrello a 4 ruote**  
**altezza cm.190**  
**peso totale Kg.22**  
**(kg.7 la sagoma - Kg.15 il carrello)**  
**spessore sagoma cm.9**  
 Mannequin in reinforced plastic  
 9 cm. thick with 4 wheel trolley  
 height 190 cm. weight 22 Kg.

**LATO ANTERIORE**  
**FRONT**

**LATO POSTERIORE**  
**BACK**

pg.1

**Art. 5026**  
**Sagoma**  
**Barret**  
**in vetroresina**  
**h. cm. 185**  
 Barret  
 fiberglass  
 Mannequin  
 185 cm. height

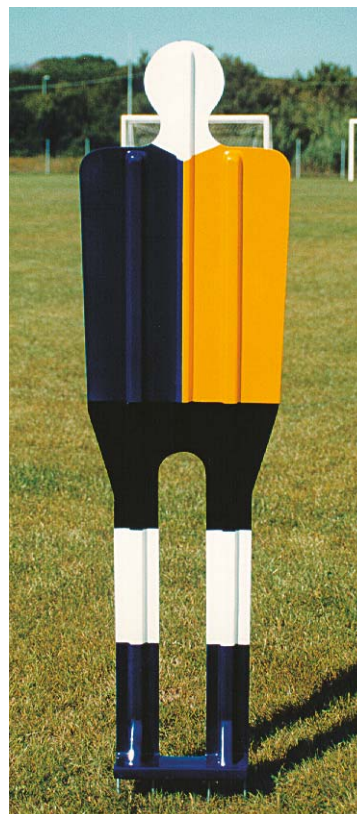

**Indistruttibili!**  
**Unbreakable!**

**4 puntali in acciaio**  
**zincato alla base, per**  
**posizionamento su**  
**terreno naturale**  
**o su carrello**  
**portasagome**

4 galvanized steel  
 spikes at the base, for  
 quick positioning on  
 natural grass  
 or on trolley

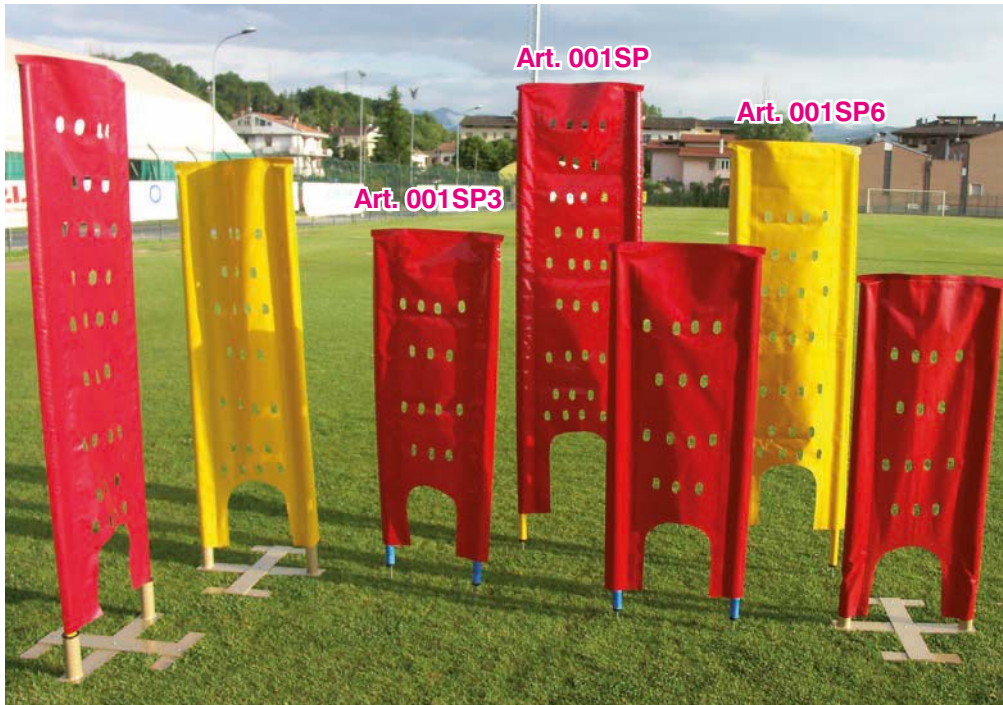

**Art. 001SP**  
**Sagoma Morbida con telo PVC forato antivento su 2 Paletti in PVC h. cm. 170 con puntale**  
 Soft pierced antiwind PVC Mannequin on 2 PVC Poles 170 cm. high with metal spike

**Art. 001SP3**  
**Sagoma Morbida con telo PVC forato antivento su 2 Paletti in PVC h. cm. 130 con puntale**  
 Soft pierced antiwind PVC Mannequin on 2 PVC Poles 130 cm. high with metal spike

**Art. 001SPA**  
**Sagoma Morbida con telo PVC forato antivento su 2 Paletti in alluminio h. cm. 170 con puntale**  
 Soft pierced antiwind PVC Mannequin on 2 aluminium Poles 170 cm. high with metal spike

pg.1

**Art. 001SP6**  
**Sagoma Morbida con telo PVC forato antivento su 2 Paletti in PVC h. cm. 160 con puntale**  
 Soft pierced antiwind PVC Mannequin on 2 PVC Poles 160 cm. high with metal spike



**Art. SA001**  
**Supporto per sagoma morbida in ferro verniciato utilizzabile su terreno sintetico**  
 Base in painted iron for positioning any soft mannequin on artificial grass

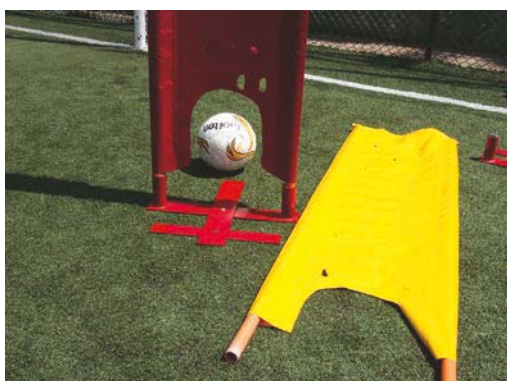

## PALETTI SLALOM - Slalom Poles



**Art. 007**  
 Paletto cm. 170  
 in PVC Ø mm. 32  
 con puntale zincato  
 colore giallo, giallo fluo,  
 rosso, bianco, blu, arancio  
 Pole 170 cm. high  
 in PVC with  
 galvanized metal spike  
 colors: yellow, fluo yellow,  
 red, white, blue, orange

pg.1



**Art. 007SP**  
 Paletto senza puntale  
 cm. 162  
 in PVC Ø mm. 32  
 colore giallo fluo,  
 rosso, bianco, blu  
 Pole 162 cm. high  
 in PVC  
 colors: fluo yellow,  
 red, white, blue

pg.1

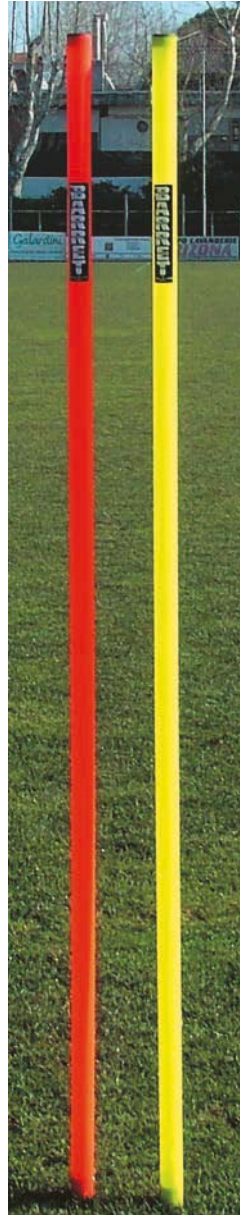

**Art. 007F**  
 Paletto in polipropilene  
 copolimero Ø 32 mm.  
 h.cm.163  
 con puntale zincato,  
 colore giallo o arancio  
 fluorescente  
 Pole 163 cm. height in  
 copolymer polypropylene  
 32 mm. with galvanized metal  
 spike - colors: fluorescent  
 yellow and orange



**Art. P007** pg.2  
 Paletto cm. 160  
 in polipropilene  
 Ø mm. 30 con  
 puntale e piattello  
 di appoggio,  
 colore giallo  
 o arancio  
 fluorescente  
 Pole 160 cm. h. in  
 polypropylene,  
 metal spike with ring  
 colors: fluorescent  
 yellow and orange

**Art. BFT**  
 Borsa porta paletti  
 (capienza massima  
 30 pezzi)  
 Bag containing  
 30 poles



pg.2



pg.2



**Art. A007**  
Paletto cm. 170  
in alluminio Ø mm. 32  
con puntale zincato  
Pole 170 cm. high  
in aluminium with  
galvanized metal spike

**Art. S007**  
Paletto flessibile  
cm. 170 in  
PVC Ø mm. 32 con  
puntale  
zincato e molla,  
colore giallo o rosso  
Pole 170 cm. h.  
in PVC with  
galvanized metal  
spike and spring  
colors: yellow, red



**Art. AS007**  
Paletto flessibile  
cm. 170 in  
alluminio Ø mm.  
32 con puntale  
zincato e molla  
Pole 170 cm. h.  
in aluminium with  
galvanized metal  
spike and spring



cm. 170



cm. 90



**Art. 007TL**  
Paletto telescopico  
Ø 32 mm  
h. cm. 170 in PVC  
con puntale zincato  
(l'altezza si riduce  
fino a cm.90)  
colore giallo  
Telescopic Pole h. 170  
cm. in PVC with galvanized  
metal spike  
Height can be reduced  
down to 90 cm.  
color yellow



pg.2

**Art. 007.25**  
Paletto  
cm. 170  
smontabile  
in PVC  
Ø 25 mm  
con puntale  
zincato svitabile  
colore giallo  
Dismountable  
Pole 170 cm.  
height in PVC  
with removable  
galvanized metal  
spike  
color yellow





**Art. 018**

Base ad imbuto in plastica per paletto Ø 32 mm con o senza puntale  
Funnel-shaped plastic base for pole with or without metal spike



**Art. 902013**

Base cilindrica in plastica riempibile con sabbia o acqua, solo per paletto Ø 32 mm senza puntale  
Cylindrical plastic base to be filled with sand or water, only for pole without metal spike

pg.2



**Art. HWRB**

Base in gomma appesantita per paletto Ø 32 mm con o senza puntale  
Weighted Rubber base for pole with or without metal spike



**Art. SP202** Base ad imbuto in plastica riempibile con sabbia, solo per paletto Ø 32 mm senza puntale  
Funnel-shaped plastic base to be filled with sand, only for pole without metal spike



h. cm. 173

**Art. 010**

Kit paletto PVC Ø 32 mm senza puntale  
Art. 007SP  
+ base Art. 018  
Kit pole without metal spike  
+ base Art. 018



h. cm. 170

**Art. 010C**

Kit paletto PVC Ø 32 mm senza puntale  
Art. 007SP  
+ base Art. 902013  
Kit pole without metal spike  
+ base Art. 902013



h. cm. 176

**Art. 010WR**

Kit paletto PVC Ø 32 mm senza puntale  
Art. 007SP  
+ base Art. HWRB  
Kit pole without metal spike  
+ base Art. HWRB



**Art. SP25**

Asta in PVC Ø 25 mm. altezza cm. 152  
PVC pole Ø 25 mm. height 152 cm.

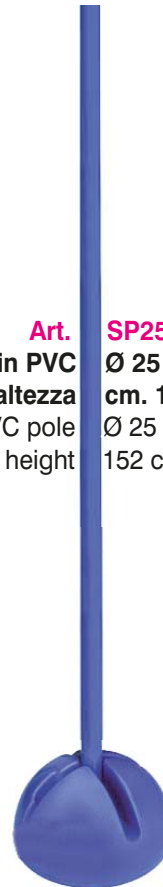

**Art. TAH-X**

Base riempibile con sabbia per aste Ø 25 mm. e cerchi piatti o tubolari  
Base to be filled with sand for poles Ø 25 mm. and flat or tubular hoops

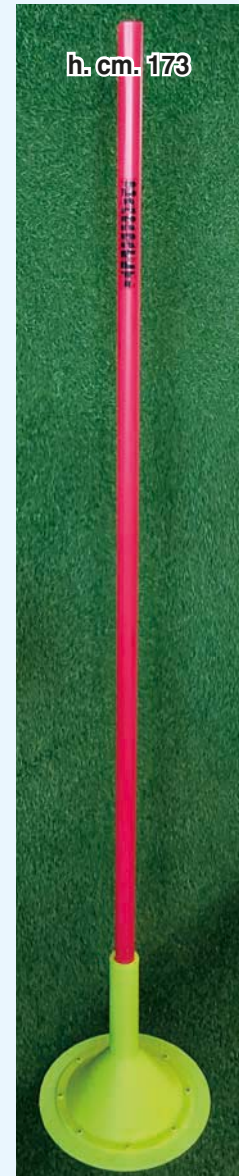

h. cm. 173

**Art. S111P** Kit paletto PVC Ø 32 mm senza puntale  
Art. 007SP  
+ base Art. SP202  
Kit pole without metal spike  
+ base Art. SP202

## DELIMITATORI - Markers

**SPECIFICARE I COLORI RICHIESTI AL MOMENTO DELL'ORDINE**

**PLEASE, SPECIFY COLORS IN YOUR ORDER**



### Art. 016

**Kit 48 Delimitatori h. cm.5 con rimessaggio colori disponibili:**

**giallo fluo, rosso, fucsia, arancio fluo, blu, bianco**

Kit 48 Markers h. 5 cm. with holder

(colors: fluo yellow, red, fuchsia, fluo orange, blue, white)

### Art. 016.1

**Kit 48 Delimitatori h. cm.5 senza rimessaggio**

(come articolo 016)

Kit 48 Markers h. 5 cm. without holder

pg.3



### Art. 016.R5 Rimessaggio in plastica per delimitatori h. cm.5 e cm.7

Plastic Holder for 5 cm. and 7 cm. height markers



### Art. 016.B

**Kit 48 Delimitatori h. cm.8 con rimessaggio giallo fluo, rosso, fucsia, arancio fluo, blu, bianco**

Kit 48 Markers 8 cm. height with holder

(fluo yellow, red, fuchsia, fluo orange, blue, white)



### Art. 016.R

**Rimessaggio in ferro per delimitatori**

**h. cm.8 e delimitatori giganti Art. 016.K**

Iron Holder for 8 cm. and giant markers



### Art. 016-TDC

**Raccoglitore in plastica per delimitatori con manico allungabile**

Adjustable length picking device for markers



### Art. 016.T



### Art. 016.T

**Kit 48 Delimitatori h. cm. 7 con rimessaggio**

**e intagli sulla sommità colori disponibili: giallo e rosso**

Kit 48 Markers with holder 7 cm. height carved on top (colors: red and yellow)



**Art. OSPT15** Delimitatore circolare piatto Ø cm.15 spessore mm.1 colori giallo, rosso, arancio e bianco  
Flat round Marker Ø 15 cm. colors: red, yellow, orange and white

**Ideali per superfici sintetiche**  
Great for indoor and turf

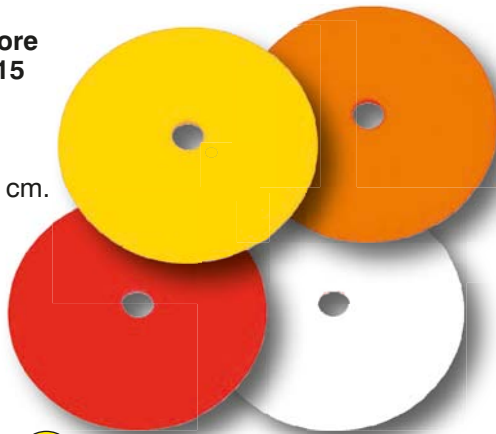

pg.3

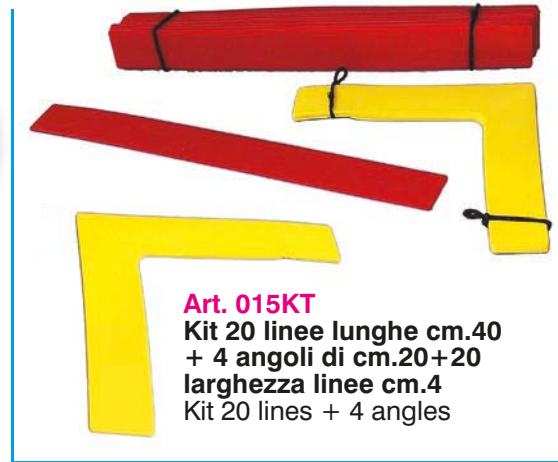

**Art. 015KT**  
Kit 20 linee lunghe cm.40 + 4 angoli di cm.20+20 larghezza linee cm.4  
Kit 20 lines + 4 angles

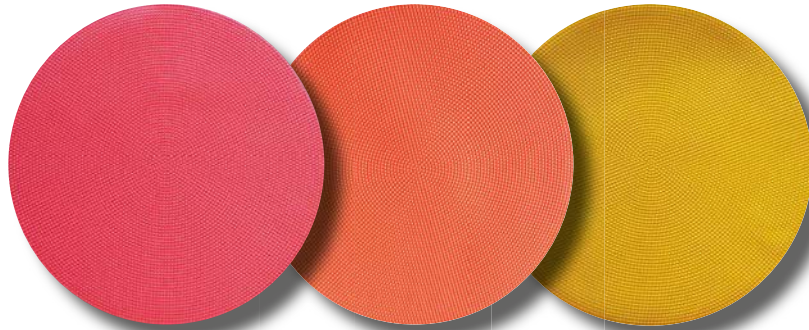

**Art. DC25**  
Delimitatore circolare piatto Ø cm.25 spessore mm.1 colori giallo, rosso, arancio  
Flat round Marker Ø 25 cm. colors: red, yellow, orange



**Art. 016.K**  
Delimitatore gigante con scanalature base Ø cm. 30 h. cm.16,5 peso gr. 100 colori: giallo, arancio e bianco  
Giant Marker 16,5 cm. height carved on top and sides colors yellow, orange and white

**Art. 016.K**

pg.3

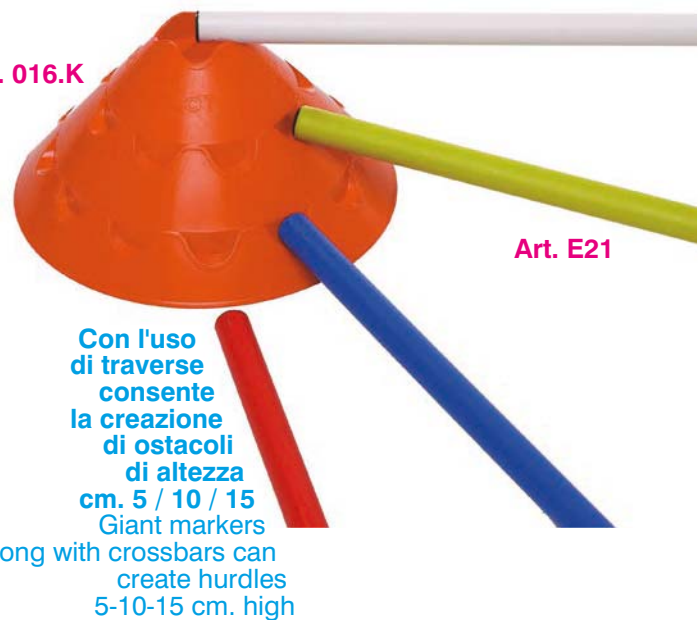

**Art. E21**

Con l'uso di traverse consente la creazione di ostacoli di altezza cm. 5 / 10 / 15  
Giant markers along with crossbars can create hurdles 5-10-15 cm. high



**Art. E21** Traversa cm.120 in PVC Ø mm. 25 - colori giallo, rosso, blu, verde, bianco  
Crossbar 120 cm. in PVC Ø 25 mm. - colors yellow, red, green, blue, white

pg.3

## BIRILLI - Cones

**Art. 205000**  
**Birillo calpestabile**  
**in caucciù termoplastico**  
**base Ø cm. 14 - h. cm. 15**  
**colori giallo e rosso**  
Soft Cone 15 cm. height  
14 cm. Ø base  
colors: red, yellow



**Art. HA7**  
**Birillo calpestabile**  
**in caucciù**  
**termoplastico**  
**base Ø cm. 17**  
**h. cm. 18**  
**colori giallo e rosso**  
Soft Cone  
18 cm. height and  
17 cm. Ø base  
colors: red, yellow

pg.3



**Art. 019**

**Art. 019**  
**Kit 24 Maxidelimitatori h. cm. 28**  
**colori: giallo, arancio, rosso,**  
**royal e fucsia**  
Kit 24 Maximarkers, height 28 cm.  
colors: yellow, orange, red, blue  
and fuchsia

**Art. 019.1**  
**Maxidelimitatore h. cm. 28**  
**fornito singolarmente**  
**colori: giallo, arancio, rosso,**  
**royal e fucsia**  
Loose Maximarker height 28 cm.  
colors: yellow, orange, red, blue  
and fuchsia

**Art. 023E**  
**Birillo economico senza fori h. cm. 30**  
**colori rosso e giallo**  
Light Cone 30 cm. height with no holes  
colors: red, yellow

pg.3





**Art. 023N**

**Birillo h. cm. 38 colore rosso, giallo o blu** - Cone height 38 cm. colors: red, yellow, blue  
**Peso gr. 200 senza foro sulla sommità** - Weight 200 gr. with no hole at top



**Peso gr. 450  
Weight 450 gr.**

**Art. 023**

**Birillo giallo h. cm. 40 con foro sulla sommità**  
 Yellow Cone 40 cm. height with hole at the top

**Art. 025**

**Birillo fucsia h. cm. 40 con foro sulla sommità**  
 Fuchsia Cone 40 cm. height with hole at the top

**Art. 024**

**Birillo rosso h. cm. 40 con foro sulla sommità**  
 Red Cone 40 cm. height with hole at the top

● pg.3



**in 4 colori  
in 4 colors**

**Art. B312**

**Birillo a 8 fori h. cm. 30 con scanalatura sulla sommità**  
 Cone with 8 holes 30 cm. height carved on top



**Art. E21 Traversa cm.120 in PVC Ø mm. 25 colori giallo, rosso, blu, verde, bianco**

Crossbar 120 cm. in PVC Ø 25 mm. - colors yellow, red, green, blue, white



**Art. I-111**  
**Clip rotante**  
**per aste**  
 Ø mm. 25 e 28  
 Rotating clip  
 for two pipes  
 Ø mm. 25 and 28



**Art. C21**  
**Birillo a 16 fori**  
**h. cm. 50**  
**con scanalatura**  
**sulla sommità**  
 Cone with 16 holes  
 height 50 cm.  
 carved on top

pg.3

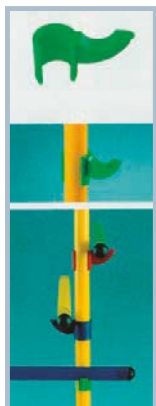

**Art. I-110**  
**Clip per montante**  
**Ø mm. 25 e 28**  
**e traversa**  
 Clip for pipe  
 Ø mm. 25 and 28  
 and crossbar

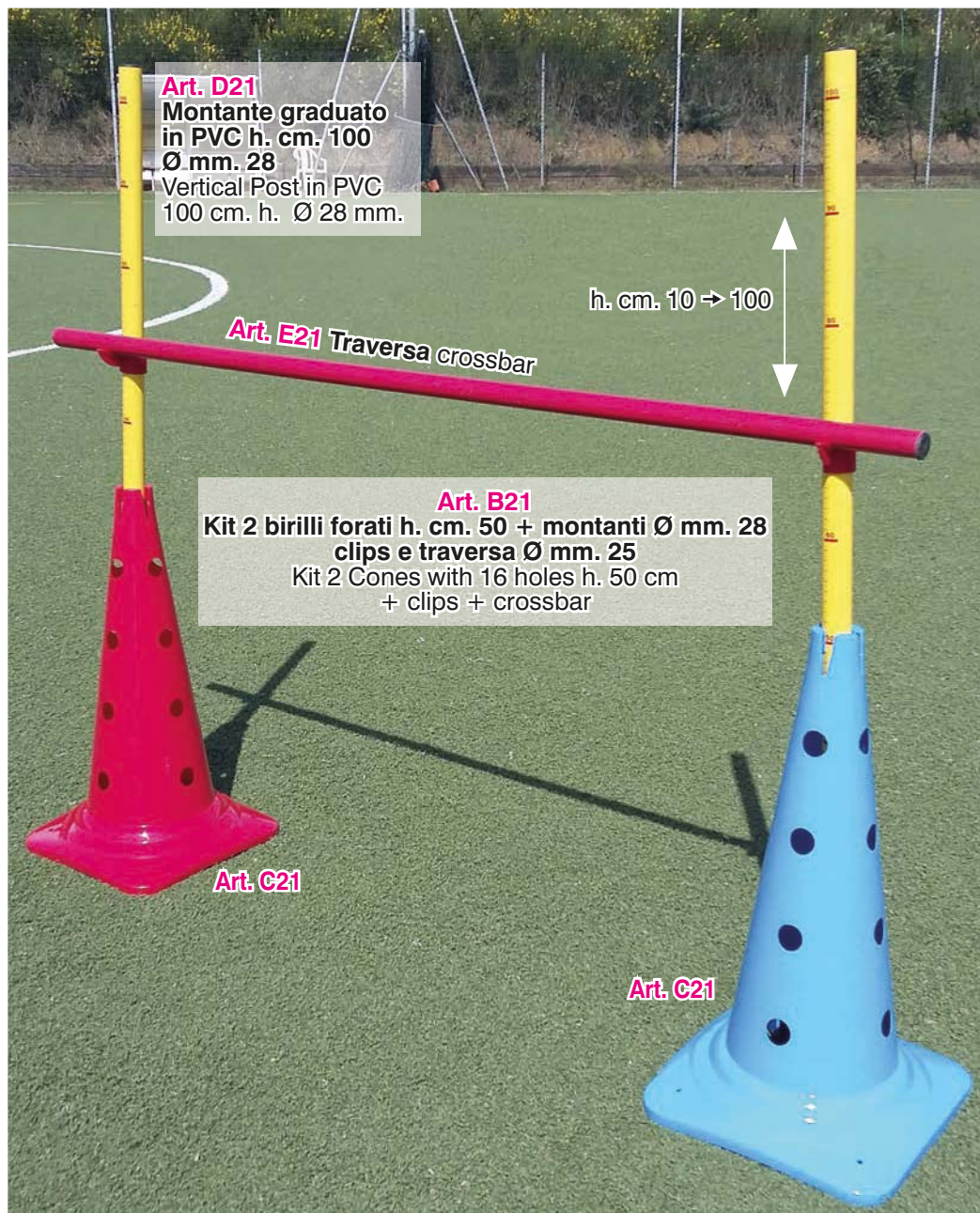

**Art. D21**  
**Montante graduato**  
**in PVC h. cm. 100**  
**Ø mm. 28**  
 Vertical Post in PVC  
 100 cm. h. Ø 28 mm.

h. cm. 10 → 100

**Art. E21** *Traversa crossbar*

**Art. B21**  
**Kit 2 birilli forati h. cm. 50 + montanti Ø mm. 28**  
**clips e traversa Ø mm. 25**  
 Kit 2 Cones with 16 holes h. 50 cm  
 + clips + crossbar

**Art. C21**

**Art. C21**



**Art. I-112**  
**Clip per asta**  
**Ø mm. 25 e 28**  
**e cerchio piatto**  
 Clip for pipe  
 Ø mm. 25 and 28  
 and flat hoop



**Art. 525**  
**Ostacolo regolabile con paletti, clips e traversa in PVC Ø mm.32**  
 Hurdle with Poles, clips and crossbar in PVC Ø 32 mm.

pg.2



**Art. 5025**  
**Ostacolo regolabile con paletti graduati, clips e traversa in PVC Ø mm.32**  
 Hurdle with Graded Poles, clips and crossbar in PVC Ø 32 mm

h. cm. 10 → 160



**Art. 012**  
**Traversa in PVC cm.110 Ø mm. 32**  
 Crossbar 110 cm. in PVC Ø 32 mm.



**Art. 012F**  
**Traversa in polipropilene copolimero cm. 110 Ø mm.32 giallo o arancio fluo**  
 Crossbar 110 cm. in copolymer polypropylene Ø 32 mm. in fluorescent yellow and orange



**Art. 525F**  
**Ostacolo regolabile con paletti h. cm. 170 con puntale, 1 traversa e 2 clips in polipropilene copolimero colore giallo o arancio fluo**  
 Hurdle with graded poles, clips and crossbar in copolymer polypropylene Ø 32 mm. (colors: fluorescent yellow and orange)

h. cm. 10 → 160

pg.2



**Art. 007SP**  
**Art. ELNR**  
**ELASTICO nero con velcro lunghezza cm.135 da fissare ai paletti come traversa ad altezza regolabile**  
 Black band length 135 cm. with velcro to be used as adjustable height crossbar

**Art. 902013**

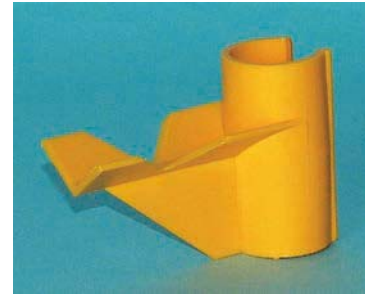

**Art. 011**  
Clip per sostegno traversa per asta Ø mm. 32 e 28  
Clip for crossbar for pipe Ø mm. 32 and 28



pg.2



**Art. CL17**  
Clip rotante per aste Ø mm. 32  
Rotating clip for two pipes Ø 32 mm.



## OSTACOLI - Hurdles



Larghezza traversa cm. 45  
45 cm. crossbar

Molto resistenti  
Highly resistant

pg.5

**Art. MH6 / MH9 / MH12**  
Mini-Over in PVC  
altezza fissa,  
cm. 15 / 23 / 30  
Ideali per i bambini  
delle scuole calcio

Mini-Over in PVC  
fixed height,  
15 / 23 / 30 cm.  
Best for soccer  
school kids



Larghezza  
Traversa cm. 80  
80 cm. crossbar

Flessibili ed indistruttibili  
Flexible and unbreakable



Tornano in posizione  
dopo ogni urto  
senza danneggiarsi  
These hurdles come  
back in position after  
any hit without being  
damaged

pg.3

pg.4



**Art. 80.12 / 80.14 / 80.16 / 80.18**  
**80.20 / 80.30 / 80.40 / 80.50 / 80.60**  
Ostacolo Over in PVC  
altezza fissa,  
cm.12-14-16-18-20-30-40-50-60  
Hurdle Over in PVC  
fixed height,  
12-14-16-18-20-30-40-50-60 cm.

pg.4

**Art.**  
**P031-A / P031 / P032**  
**P033 / P034 / P035**  
Ostacolo Over  
in PVC Ø mm. 32  
altezza fissa  
disponibile  
da 12 a 60 cm.  
Hurdle Over in PVC,  
fixed height  
available  
from 12 to 60 cm.



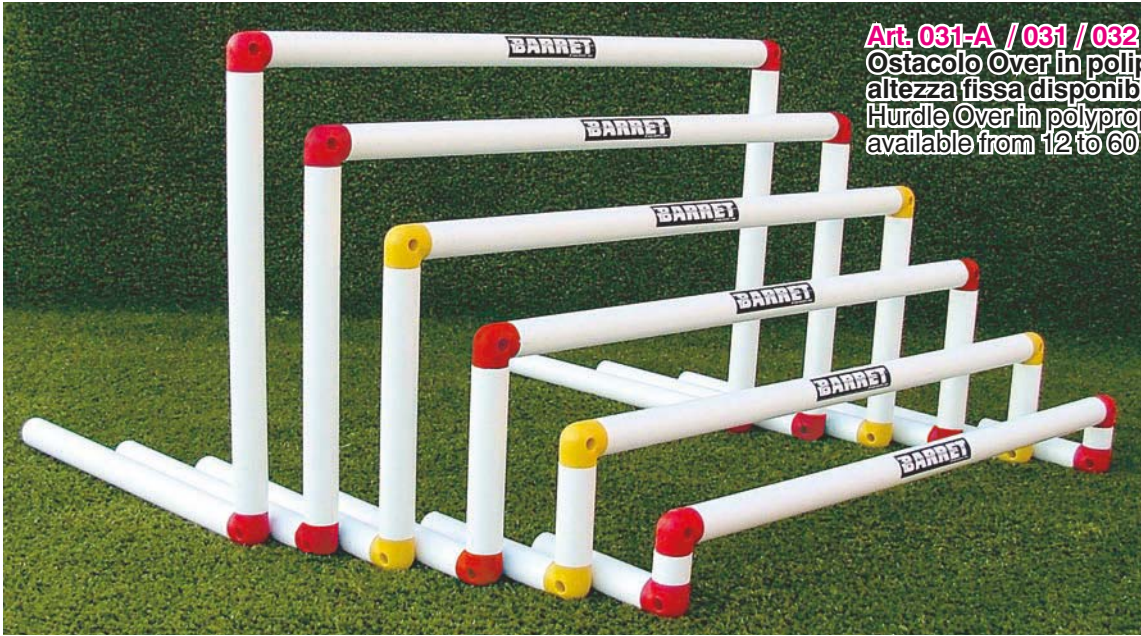

**Art. 031-A / 031 / 032 / 033 / 034 / 035**  
Ostacolo Over in polipropilene Ø mm. 40  
altezza fissa disponibile da 12 a 60 cm.  
Hurdle Over in polypropylene, fixed height  
available from 12 to 60 cm.

**Polipropilene  
copolimero  
Ø 40 mm.  
altamente  
resistente e  
flessibile fino a  
-5 gradi!**  
Polypropylene  
copolymer  
40 mm. highly  
resistant and  
elastic till minus  
5 degrees!

pg.4



**Art. 235-1 / 235-2 / 235-3 / 235-4 / 235.5 / 235.6**  
Ostacolo Over  
in ferro verniciato altezza fissa  
disponibile da 12 a 60 cm.  
Hurdle Over in painted iron,  
fixed height available  
from 12 to 60 cm.

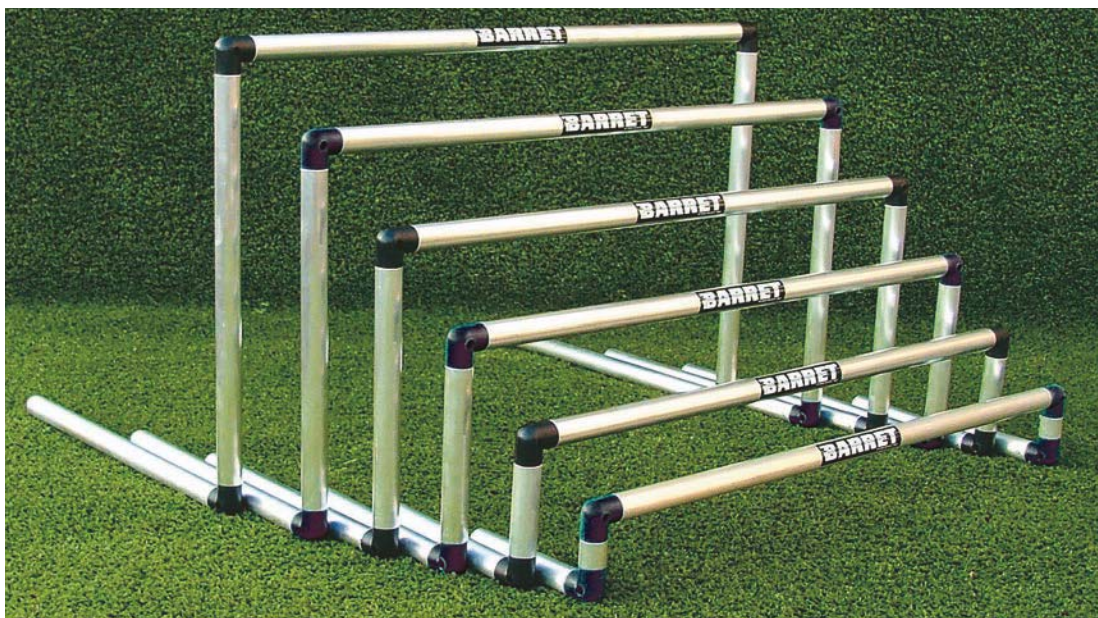

**Art. A031-A / A031 / A031-B / A032 / A033 / A034 / A035**  
Ostacolo Over in alluminio Ø mm. 32 altezza fissa disponibile da 12 a 60 cm.  
Hurdle Over in aluminium, fixed height available from 12 to 60 cm.





pg.5

**Art. 239TI**

**Ostacolo con traversa inclinata altezza variabile da cm. 12 a cm. 60 in ferro verniciato - larghezza mt. 2 (scomponibile) Ordinare quantità multipla di 3 pezzi**

Hurdle with inclined crossbar height from 12 cm. to 60 cm. in painted iron - width 2 meters (dismountable in 3 pieces) Please order multiple quantities of 3 pieces

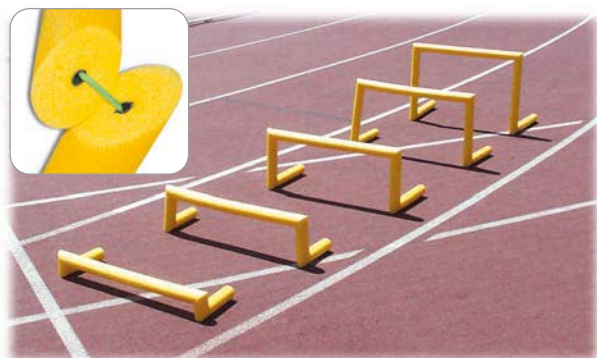

pg.5

**Art. P15421**

**Serie 5 ostacoli Over supersoft in polietilene espanso colore giallo, leggerissimi ideali per uso indoor**

**altezza cm. 10-20-30-40-50 (il set comprende un ostacolo per ciascuna altezza)**

Set of 5 Hurdles over supersoft yellow color very light, best for indoor use fixed height cm. 10-20-30-40-50

**Art. 031-AF  
031F / 031-BF / 032F  
033F / 034F / 035F**

**Ostacolo over  
altezza fissa  
cm. 12-20-30-40-50-60  
in polipropilene  
copolimero  
alta resistenza  
Ø mm. 32  
colori: giallo e arancio  
fluorescente**

Over Hurdle 12 - 20 - 30  
40 - 50 - 60 cm. height  
polypropylene  
copolymer  
pipe Ø mm. 32  
(colors: fluorescent  
yellow and orange)



pg.4

**Polipropilene  
copolimero  
FLUO  
altamente  
resistente e  
flessibile fino a  
-5 gradi!  
Polypropylene  
copolymer  
fluorescent  
highly  
resistant and  
elastic till minus  
5 degrees!**

**Art. C031 / C032 / C033 / C034**

**Ostacolo Over  
con cerniere (richiudibile) in  
polipropilene  
copolimero Ø mm. 32  
colore giallo o arancio  
fluorescente  
massima altezza  
cm. 20 - 30 - 40 - 50**

Hinged Hurdle Over  
(foldable) in polypropylene  
copolymer pipe Ø mm. 32  
fluorescent yellow and orange  
20 - 30 - 40 - 50 cm.  
maximum height



pg.4



**Art. 006**  
**Ostacolo con cerniere (richiudibile)**  
**altezza regolabile da 10 a 60 cm.**  
**in PVC Ø mm. 32**  
Hinged Hurdle (foldable)  
adjustable height  
from 10 to 60 cm. in PVC



pg.5

**Art. 006F**  
**Ostacolo con cerniere (richiudibile)**  
**altezza regolabile da 10 a 60 cm.**  
**in polipropilene copolimero Ø mm. 32**  
**colore giallo o arancio fluorescente**  
Hinged Hurdle (foldable) adjustable height  
from 10 to 60 cm. in polypropylene  
copolymer pipe Ø 32 mm.  
(colors: fluorescent yellow and orange)



**Art. A004** **Ostacolo con cerniere (richiudibile)**  
**altezza regolabile da 10 a 60 cm.**  
**in alluminio Ø mm. 32**  
Hinged Hurdle (foldable) adjustable height  
from 10 to 60 cm. in aluminium



**Art. P0055**  
**Ostacolo Telescopico graduato,**  
**altezza regolabile**  
**da 40 a 60 cm. in PVC**  
Telescopic Hurdle - graded - height adjustable  
from 40 to 60 cm. in PVC



Art. P0055

**Completamente smontabili,**  
**minimo ingombro!**  
Dismountable legs,  
easy to transport

pg.5

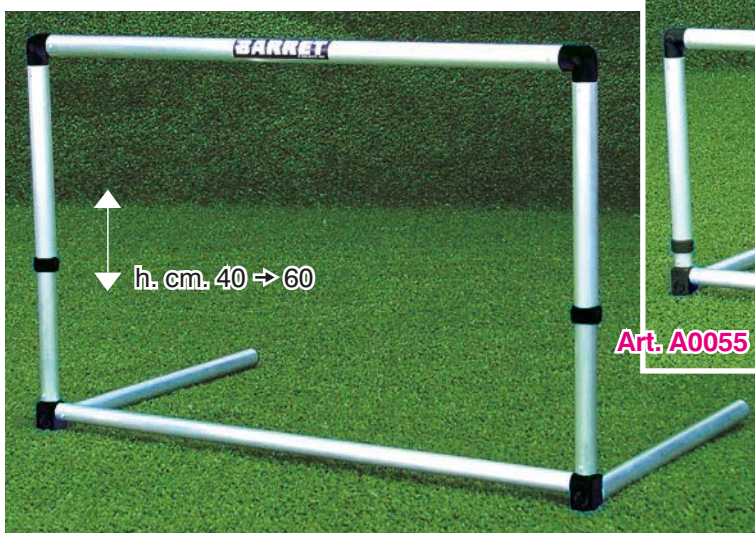

Art. A0055

**Art. A0055**  
**Ostacolo Telescopico graduato, altezza regolabile**  
**da 40 a 60 cm. in alluminio**  
Telescopic Hurdle - graded - height adjustable  
from 40 to 60 cm. in aluminium

**Montanti graduati**  
**in cm.**  
Graded in cm.

**Completamente**  
**smontabili,**  
**minimo ingombro!**  
Dismountable legs,  
easy to transport



**Art. P005**  
**Ostacolo Telescopico graduato,**  
**altezza regolabile da 60 a 100 cm. in PVC**  
Telescopic Hurdle - graded - height adjustable  
from 60 to 100 cm. in PVC

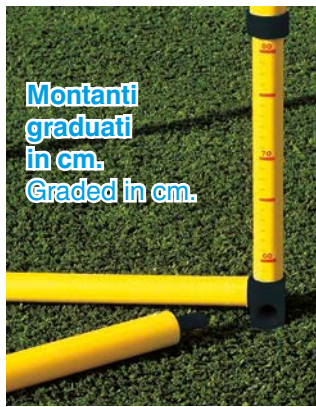
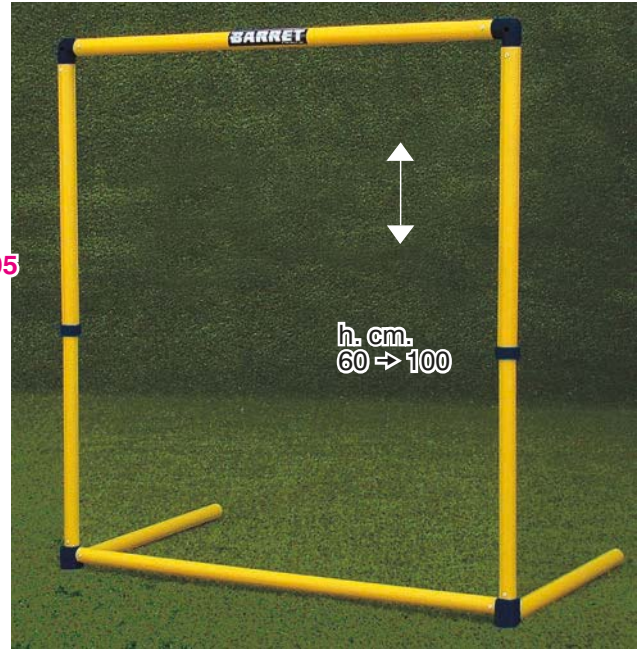
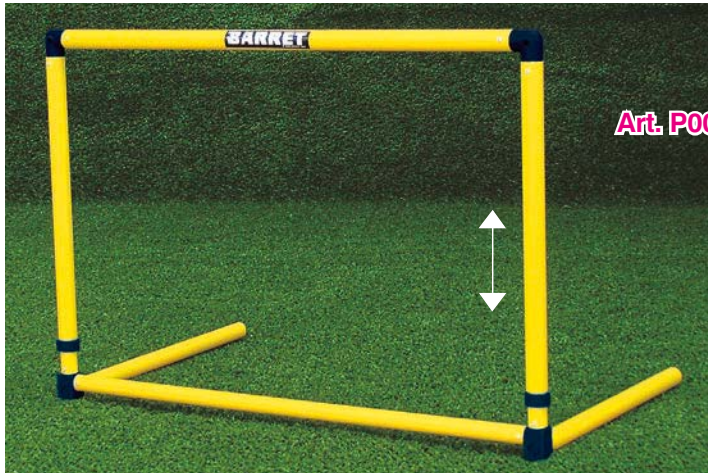

**Completamente smontabili,**  
**minimo ingombro!**  
Dismountable legs,  
easy to transport

pg.5



**Art. A005**  
**Ostacolo Telescopico graduato,**  
**altezza regolabile da 60 a 100 cm. in alluminio**  
Telescopic Hurdle - graded  
height adjustable from 60 to 100 cm. in aluminium

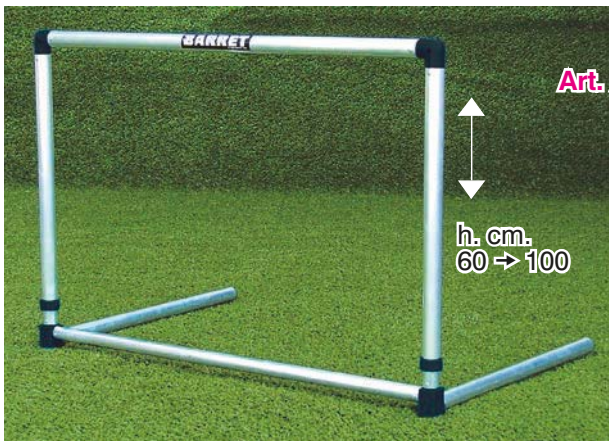

**Completamente smontabili,**  
**minimo ingombro!**  
Dismountable legs,  
easy to transport

**Montanti graduati in cm.**  
Graded in cm.



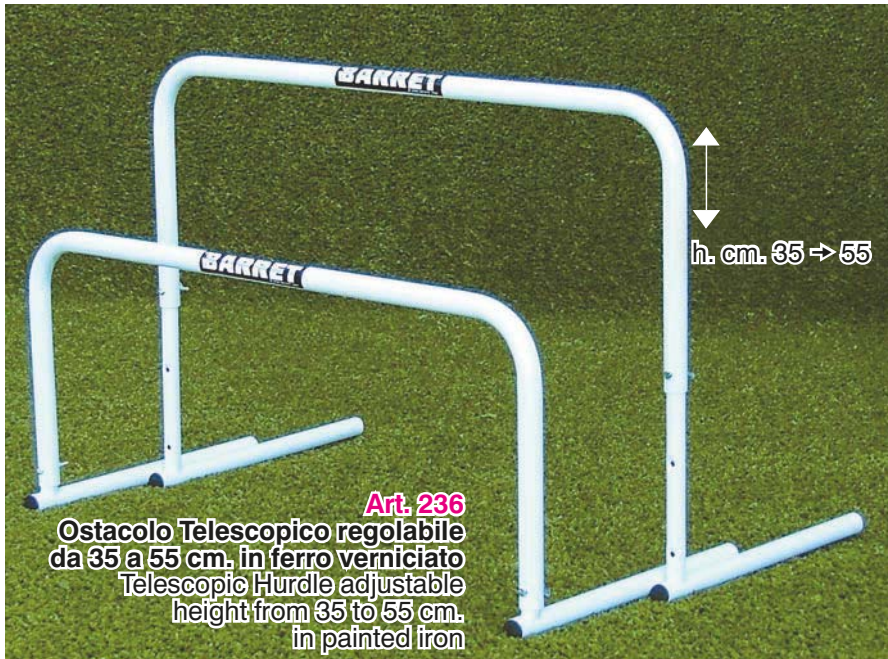

Art. H6912  
Mini-Ostacolo per bambini  
in plastica antiurto  
larghezza traversa cm. 45  
altezza regolabile a cm. 15-23-30  
Mini-Hurdle  
in plastic for kids  
45 cm. wide  
adjustable height  
at 15-23-30 cm.

pg.5



Art. 036  
Mini-Ostacolo  
per bambini  
regolabile  
da 10 a 50 cm.  
in plastica  
Mini-Hurdle for kids  
adjustable height  
from 10 to 50 cm.  
in plastic

**IDEALI PER USO  
INDOOR  
E PER PALESTRE**

**For indoor use**



**SEMPRE IN PIEDI  
DOPO OGNI URTO!  
THEY ALWAYS COME  
BACK UP AFTER  
ANY HIT!**

pg.5

**Art. 5020 / 5021 / 5022 / 5023**  
Ostacolo Basculante in PVC Ø mm. 28  
altezza fissa cm. 30 / 40 / 50 / 60  
Self-Straightening Hurdle in PVC fixed height,  
available in 30 / 40 / 50 / 60 cm.



pg.5

**Art. A5020 / A5021 / A5022 / A5023**  
Ostacolo Basculante in alluminio Ø mm. 28  
altezza fissa cm. 30 / 40 / 50 / 60  
Self-Straightening Hurdle in aluminium  
fixed height, available in 30 / 40 / 50 / 60 cm.

**SEMPRE IN PIEDI  
DOPO OGNI URTO!  
THEY ALWAYS COME  
BACK UP AFTER  
ANY HIT!**



## KIT CALCIO TENNIS - Soccer Tennis Kits

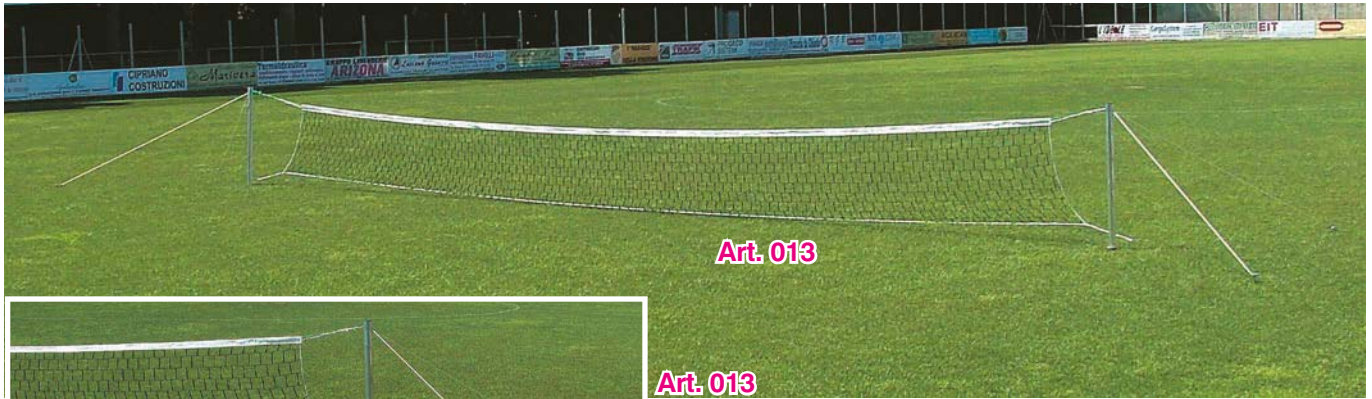

**Art. 013**



**Art. 013**

**Kit Calcio Tennis pali in alluminio sezione mm. 60 completo di rete mt. 9,85 con tiranti, picchetti e nastro di delimitazione, utilizzabile solo su terreni naturali**  
Soccer Tennis Kit aluminium poles 60 mm. with 9,85 meter net, tightening ropes, pegs and tape for bounds - for natural grass

pg.6



**Art. 014**

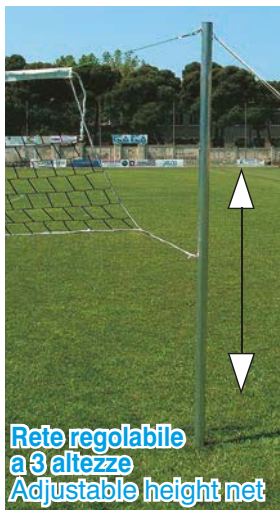

**Rete regolabile a 3 altezze**  
Adjustable height net

**Art. 014**  
**Kit Calcio Tennis pali in alluminio sezione mm. 60 completo di rete mt. 9,85 regolabile a 3 altezze (cm. 110/170/230) con tiranti, picchetti e nastro di delimitazione, utilizzabile solo su terreni naturali**  
Soccer Tennis Kit aluminium poles 60 mm. with 9,85 meter net adjustable at 3 different heights, tightening ropes, pegs and tape for bounds for natural grass



**Art. 014**



**Art. NS200**

pg.29

**Rotolo nastro stradale bianco/rosso mt. 200 (compreso nei kit Art. 013 e Art. 014)**  
Red/White Tape length 200 meters (supplied with kit Art. 013 and Art. 014)



**Art. 013.N**  
Kit Calcio Tennis pali in PVC  
completo di rete mt. 3,30  
tiranti e picchetti  
per terreni naturali  
Soccer Tennis Kit PVC poles  
with 3,30 meter net  
tightening ropes and pegs  
for natural grass

pg.5



**Art. 013.G** Kit calcio tennis pali in PVC  
con rete mt.10 - altezza cm.130  
con tiranti, picchetti e sacca  
per terreni naturali  
Soccer Tennis Kit PVC poles  
10 meter long 130 cm. height net with  
ropes, steel hooks and bag  
for natural grass



pg.5



**Art. 013.P**  
Kit calcio tennis  
con rete mt. 3  
utilizzabile anche  
su terreni sintetici  
o indoor  
con sacca  
Soccer Tennis Kit  
3 meter net - with bag  
also for artificial  
grass or indoor



**Art. 013.SP**

**Kit calcio tennis con rete cm.  
450x170  
utilizzabile anche  
su terreni sintetici o indoor**

**con sacca**

Soccer Tennis Kit 4,5x1,7 meter net  
with bag, also for artificial grass  
or indoor



● pg.6

**Art. 013.60**

**Kit calcio tennis  
con rete cm. 600x90  
utilizzabile anche  
su terreni sintetici  
o indoor con sacca**

Soccer Tennis Kit  
6,0x0,9 meter net  
with bag, also  
for artificial grass  
or indoor



**Art. 013.S**

**Kit Calcio Tennis TATTICO  
pali in polipropilene  
completo di rete in PVC mt. 2,30 regolabile in  
altezza, tiranti e basi in ferro verniciato  
utilizzabile anche su terreni sintetici o indoor**

Soccer Tennis Kit polypropylene poles  
with adjustable height PVC net 2,30 meter long,  
tightening ropes and painted steel bases  
also for artificial grass or indoor

**Nasconde per qualche istante la visione  
del pallone, determinando risposte a livello  
neuromuscolare e migliorando cinestesia e  
sensibilità nel tocco di palla**

This Soccer Tennis Kit hides the ball from  
player's visibility stimulating neuro muscular  
reflexes and improving ball control

● pg.6



**Art. 013.SB**

**Borsa per Kit calcio tennis  
Art. 013.S**

Bag to carry soccer tennis  
kit Art. 013.S



## ARCHI DI PRECISIONE - Precision passing arcs

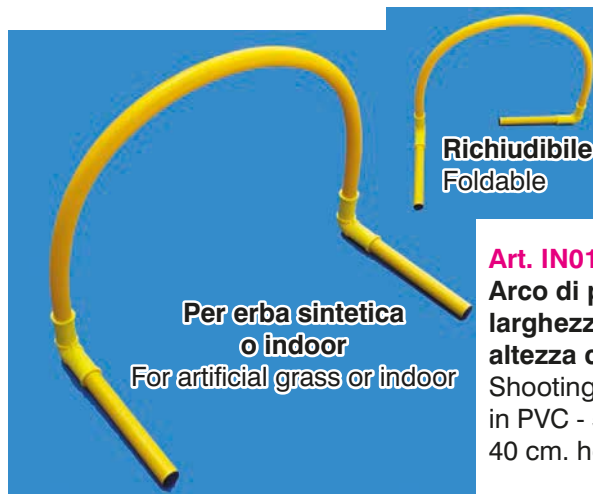
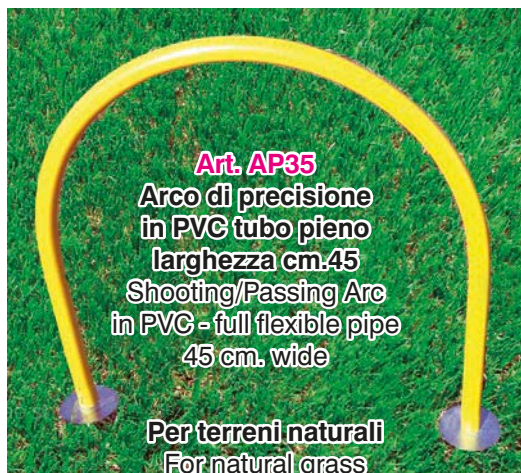

pg.5

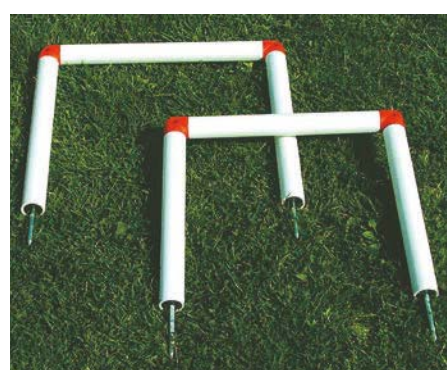

**Art. 020 / 021 / 022**  
Arco di precisione in polipropilene  
Ø 40 mm. cm. 45x45 / 40x40 / 35x35  
Shooting/Passing Arc  
in polypropylene Ø 40 mm.  
dim. 45x45 / 40x40 / 35x35 cm.



**Art. A020 / A021 / A022**  
Arco di precisione  
in alluminio Ø 32 mm.  
cm. 45x45 / 40x40 / 35x35  
Shooting/Passing Arc  
in aluminium Ø 32 mm.  
dim. 45x45 / 40x40 / 35x35 cm.



## FORCHE - Heading Trellises



**Art. F203**

pg.6

**Art. F203**

Forca doppia  
in ferro verniciato  
telescopica, smontabile  
bussola inclusa

altezza da terra cm. 300  
(palloni esclusi)

Double Heading Trellis

in painted iron

telescopic, dismountable,  
underground socket included,  
height 300 cm. off ground  
(balls not included)



**Art. 039.4 / 039.5**

Pallone per  
forca in pelle sintetica  
disponibile mis. 4 e 5  
Ball for Heading Trellis,  
in synthetic leather  
available size 4 and 5



pg.6

**Art. 037F**

Forca singola  
in acciaio zincato,  
con zavorra,  
per erba sintetica o indoor  
altezza da terra cm.300  
(pallone escluso)

Single Heading Trellis  
in galvanized iron weighted for  
artificial grass or indoor  
height 300 cm. off ground  
(ball not included)



**Art. ULTVE5**

Pallone per forca  
Trial n. 5

in gomma  
doppio strato  
gr. 420

Ø cm. 21,5

Trial rubber Ball  
for Heading trellis  
size 5  
double stratum

**Art. ULTVE4**

Pallone per forca Trial n. 4

in gomma doppio strato gr. 250 Ø cm. 20

Trial rubber Ball for Heading trellis size 4 double stratum



**Art. 038**  
**Forca doppia**  
**in alluminio**  
**tubo sezione 60 mm.**  
**altezza da terra cm.300**  
**(palloni esclusi)**  
 Double Heading Trellis  
 in aluminium  
 pipe section 60 mm.  
 300 cm. height off ground  
 (balls not included)

**Art. B038**  
**Bussola per forca**  
**Art. 038 (optional)**  
 Underground socket  
 for Art. 038 (optional)



**Art. ACTP40**  
**Attrezzo per l'allenamento**  
**al colpo di testa**  
**applicabile a porte di qualsiasi tipo**  
**per mezzo di fettucce elastiche,**  
**in PVC Ø mm. 40**  
**(pallone escluso)**  
 Header training tool  
 to be easily applied to goals of any type  
 by means of elastic tapes,  
 PVC pipe Ø 40 mm.  
 (ball not included)



**Con questo attrezzo**  
**è possibile verificare**  
**giornalmente i**  
**miglioramenti**  
**nell'elevazione**  
**degli atleti**  
 This instrument tests  
 players' daily jump  
 improvements

**Art. HJT Head Jump Tester - strumento polivalente di misurazione**  
**ed allenamento, permette la valutazione delle qualità muscolari**  
**degli arti inferiori, dell'elevazione dei giocatori, del loro modo di**  
**colpire la palla di testa e dell'ampiezza del tuffo del portiere**  
 Instrument that allows the training and measurement of jump ability of  
 players and goalkeepers

## BARRIERE SPECIALI - GK TRAINING



Video dimostrativo disponibile  
su [www.barretsport.com](http://www.barretsport.com)  
Video available on  
[www.barretsport.com](http://www.barretsport.com)

La palla passa  
attraverso le  
finestre senza  
perdere velocità

Telo cm.250x173  
250x173 cm. sheet

Ball goes through the windows without  
losing speed

**Art. 003WB**  
**BARRIERA CON FINESTRE**  
per l'allenamento ai calci  
di punizione e per il  
miglioramento dei tempi  
di reazione del portiere in  
caso di tiri improvvisi  
**kit completo**  
WINDOW BARRIER for  
free kicks and Goalkeeper  
training to fast and sudden  
shots **complete kit**

pg.1

**Art. 003WBS**  
**STRUTTURA  
SUPERIORE**  
barriera con  
finestre, applicabile  
al carrello porta  
sagome Art. 003  
Window Barrier  
UPPER PART  
to be fixed upon  
trolley Art. 003



**Art. 003RX**  
**BARRIERA FILTRANTE  
REFLEX kit completo**  
REFLEX FILTERING  
BARRIER on wheels -  
**complete kit**



**Nuovo sistema  
di fissaggio**  
New more  
resistant elastics  
and hooks

pg.1

**Art. 003RXS**  
**STRUTTURA  
SUPERIORE** barriera  
filtrante REFLEX,  
applicabile al carrello  
porta sagome Art. 003  
Reflex Filtering Barrier  
UPPER PART  
to be fixed upon  
trolley Art. 003



**Art. 003RXS**

**Art. 003**

**INNOVATIVO ATTREZZO FONDAMENTALE PER  
L'ALLENAMENTO DEI RIFLESSI DEL PORTIERE.  
LA PALLA (INVISIBILE PER IL PORTIERE AL  
MOMENTO DEL CALCIO) FILTRA ATTRAVERSO  
LE STRISCE ED ARRIVA IN PORTA  
ALL'IMPROVISO ASSUMENDO TALVOLTA  
TRAIETTORIE IMPREVEDIBILI.**

**ATTREZZO DA POSIZIONARE IN PROSSIMITÀ  
DELL'AREA PICCOLA**

**A revolutionary device for goalkeeper's reflex  
training.  
The goalkeeper cannot see the ball until it  
passes through the stripes. The direction of the  
ball is often unpredictable!**

**To be placed not too far from goalkeeper's area**



**L'ATTREZZO PUO' INOLTRE ESSERE UTILIZZATO COME UNA  
COMUNE BARRIERA PER L'ALLENAMENTO DEI CALCI DI  
PUNIZIONE**

**It is also very useful for free kick practising for both kicker and  
goalkeeper!**



## MURI - TELAI CON RETE - Rebounders - Iron frames with nets



**Art. 5011**

**Muro per allenamento portieri in vetroresina montato su telaio con 4 ruote**  
Fiberglass Goalkeeper Rebounder mounted on frame with 4 wheels

pg.6

**Dimensioni:**  
altezza cm.200  
larghezza cm.130  
profondità cm.80  
peso Kg.100

Dimensions:  
height 200 cm.  
width 130 cm.  
depth 80 cm.  
weight 100 Kg.

**Calciando o lanciando la palla verso il muro essa assumerà direzioni di rimbalzo imprevedibili, favorendo l'allenamento dei riflessi del portiere**

By kicking or throwing the ball against the wall it will rebound in different directions, testing and training GK's reflexes



**Zavorra in cemento inclusa**  
Concrete ballast included

**Consente l'allenamento con o senza il preparatore atletico**  
Goalkeeper can exercise by himself as well



**Con superficie superiore a semisfere e superficie inferiore liscia**  
Upper side with hemispheres and smooth lower side



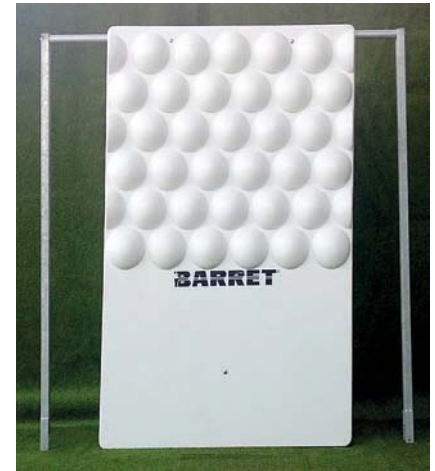

**Art. KMC3S**

**Kit superiore muro allenamento portieri per adattamento a carrello Art. NCP3S oppure Art. 003**  
Rebounder kit upper part to be fixed upon trolley Art. NCP3S or Art. 003

**Art. 5012SC**

**Muro per allenamento portieri in vetroresina cm. 200x130 installato su carrello in acciaio zincato con ruote**

Fiberglass Goalkeeper rebounder 200x130 cm. installed on a galvanized steel trolley with wheels

**Rimuovendo il pannello in vetroresina ed eventualmente il telaio di sostegno, si può utilizzare il carrello porta 3 sagome Art. NCP3S**

By removing the fiberglass panel and the support frame, you can use the trolley for carrying 3 mannequins Art. NCP3S

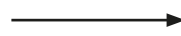

**Art. PVLSC**

**Pannello in vetroresina con superficie superiore a semisfere e superficie inferiore liscia, munito di ganci e staffa per ancoraggio - dimensioni cm. 200x130**

**Può essere acquistato separatamente ed installato facilmente sulla Barriera Filtrante Reflex Art. 003RX oppure sulla Barriera con Finestre Art. 003WB**

Fiberglass panel with upper hemisphere surface and lower smooth surface, equipped with hooks and anchor bracket - size 200x130 cm. It can be purchased separately and easily installed both on the Reflex Filtering Barrier Art. 003RX and on the Window Barrier Art. 003WB



Kg. 50



**Art. 5010**

**Muro per allenamento giocatori a 3 facce in vetroresina montato su telaio con 3 ruote**  
3 side Fiberglass Players' Rebounder mounted on frame with 3 wheels  
Dimensions: 1,3 m. width x 1,1 m. height every side weight 50 Kg.



pg.6



**Art. 5050**

**Muro per allenamento giocatori a 2 facce di cui una ad inclinazione regolabile, interamente in vetroresina montato su telaio con 4 ruote**  
2 side Fiberglass Players' Rebounder mounted on frame with 4 wheels one side can be inclined

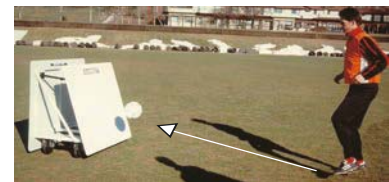

Kg. 50

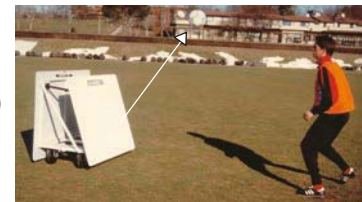

**Dimensioni:**  
m. 1,3 larghezza x m. 1,1 altezza ciascuna faccia  
**peso Kg. 50**  
Dimensions:  
1,3 m. width x 1,1 m. height every side weight 50 Kg.

**Attraverso l'utilizzo della parete ad inclinazione regolabile è possibile determinare traiettorie di risposta della palla verso l'alto al fine di sollecitare il tiro al volo, il colpo di testa ed il controllo di palla**  
Thanks to the adjustable inclination you can get an upward ball rebound and train acrobatic shooting, headers and ball control



**Art. MP501N**

**Muro prismatico in vetroresina a 3 facce lisce di dimensioni  
cm.107x140 - cm.107x120 - cm.107x108 - peso Kg.48 - con asole per il trasporto  
\*\*utilizzabile contemporaneamente da 2 lati ed in 4 diverse posizioni\*\***

3 side Fiberglass Players' Rebounder with side dimensions  
107x140 cm. - 107x120 cm. - 107x108 cm. weight 48 Kg. with slots for transport  
**\*\*allows 4 different training positions on both sides simultaneously\*\***

pg.6



Permette di ottenere la più ampia varietà di rimbalzi e traiettorie, utili per il miglioramento del controllo di palla, del passaggio, del tiro a volo e del colpo di testa

**1**

**Posizione "in piedi" con 3 facce perpendicolari al terreno di gioco**  
Standing position with all sides perpendicular to the ground



**2**

**Posizione con base a terra cm.107x108**  
**Allenamento con superfici di rimbalzo ad inclinazione alta e medio-alta**  
Position with 107x108 cm. base  
Training with high and medium inclination rebounding sides

Allows the widest variety of rebounds in order to improve ball control, passing and shooting



**3**

**Posizione con base a terra cm.107x120**  
**Allenamento con superfici di rimbalzo ad inclinazione alta e bassa**  
Position with 107x120 cm. base  
Training with high and low inclination rebounding sides



**Rinforzo interno per l'ottimizzazione del rimbalzo**  
Internal reinforcement for rebound improvement

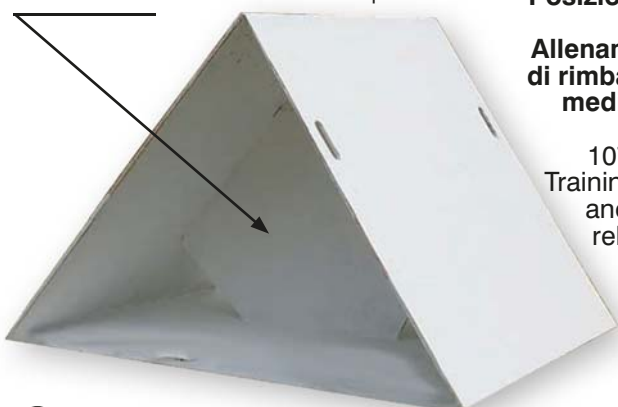

**4**

**Posizione con base a terra cm.107x140**  
**Allenamento con superfici di rimbalzo ad inclinazione medio-bassa e bassa**  
Position with 107x140 cm. base  
Training with medium-low and low inclination rebounding sides



**Art. PLRB16**

**Muro prismatico in vetroresina a 3 facce lisce  
larghezza cm.130 - altezza massima cm.65  
con asole per il trasporto - peso kg.24**

**\*\*utilizzabile contemporaneamente da 2 lati ed in 3 diverse posizioni\*\***

3 side Fiberglass Players' Rebounder  
width 130 cm. - maximum height 65 cm.  
with slots for transport - 24 kg. weight

**\*\*allows 3 different training positions on both sides simultaneously\*\***

pg.6

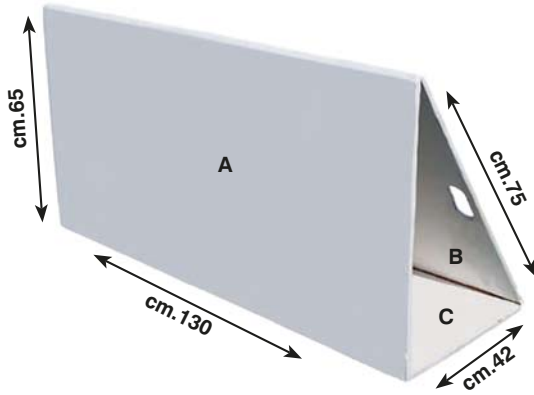

**1**

**Posizione con superficie A perpendicolare  
al terreno e superficie B molto inclinata**  
Position with 90 degrees A side and high inclination B side

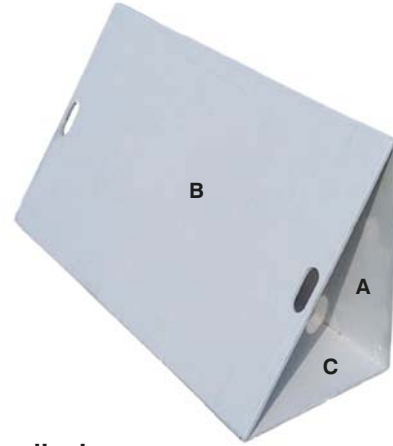

**Video dimostrativo disponibile  
su [www.barretsport.com](http://www.barretsport.com)**

Video available on  
[www.barretsport.com](http://www.barretsport.com)

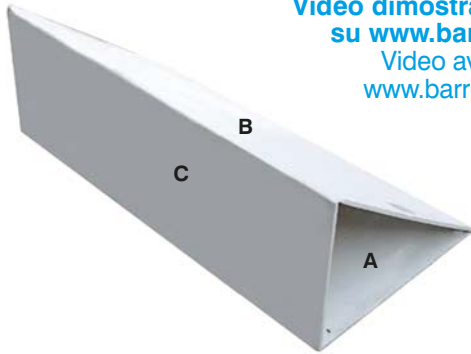

**2**

**Posizione con superficie C perpendicolare  
al terreno e superficie B inclinata**  
Position with 90 degrees C side and low inclination B side

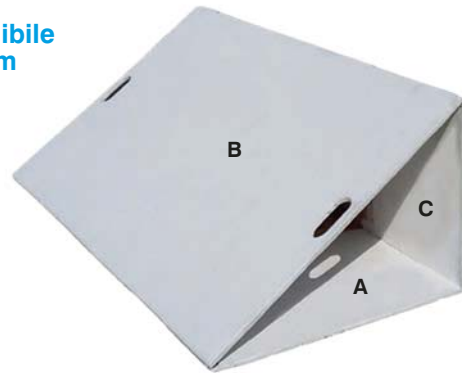

**Si consiglia di utilizzare una  
zavorra all'interno dell'attrezzo  
per conferire maggiore stabilità**  
It is recommended to place a  
weight inside for great stability

**3**

**Posizione con superfici A e C  
a diversa inclinazione**  
Position with A and C sides differently inclined

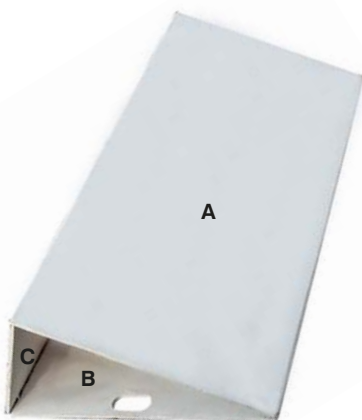

**Permette di ottenere la più ampia  
varietà di rimbalzi e traiettorie, utili  
per il miglioramento del controllo di  
palla, del passaggio, del tiro a volo  
e del colpo di testa**

**Rinforzo interno  
per l'ottimizzazione del rimbalzo**  
Internal reinforcement for rebound improvement

**Allows the widest  
variety of rebounds in  
order to improve ball  
control, passing and  
shooting**

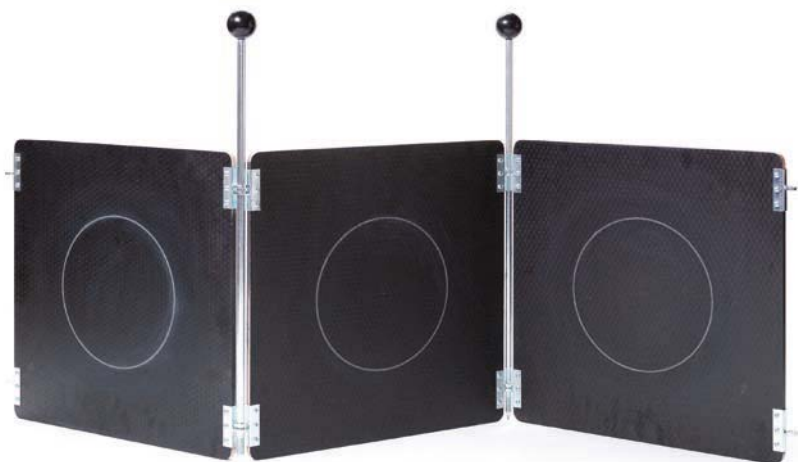

pg.7

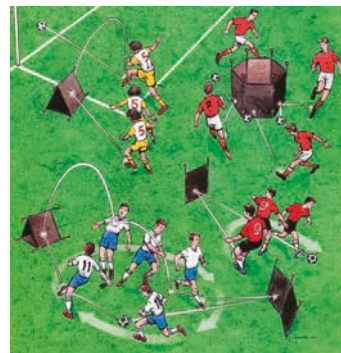

**Art. PAL PAL ORIGINAL - Kit 3 pannelli orientabili in legno finlandese trattato a 5 strati rivestiti in gomma, completo di 4 aste metalliche di fissaggio, 6 pomelli di sicurezza e 1 martello per il fissaggio**

Pal Original - Kit 3 rebounding sides in Finnish multi stratum wood covered with rubber, with 4 metal pegs, 6 safety protections and 1 hammer

**Ideale per l'effettuazione di esercizi individuali e di gruppo volti al miglioramento della coordinazione motoria, del controllo di palla, del passaggio, del tiro e del gioco aereo**  
Very useful for individual and group exercises to improve coordination, ball control, passing and shooting



pg.6

**Art. TM001**

**Muro triangolare in legno multistrato marino, trattato con vernice impermeabilizzante dimensioni lato cm.150x50**

**Attraverso l'uso in posizione verticale è possibile determinare traiettorie di risposta della palla verso l'alto al fine di sollecitare il tiro a volo, il colpo di testa e lo stop**

Triangular rebounder made of marine wood treated with special paint against humidity - side size 150x50 cm. By placing it in vertical position you will receive an upward ball rebound to train acrobatic shooting, header and ball control.



pg.7

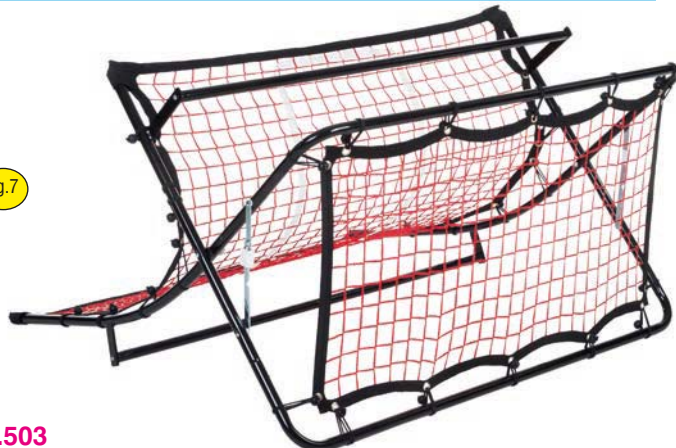

**Art. PTI.503**

**Telaio con rete in acciaio verniciato, bifacciale ricurvo su un lato - inclinazione regolabile dim. cm. 111x105x63**  
2 face adjustable inclination iron frame with net for goalkeepers and players size 111x105x63 cm.



**Art. SCVR16**

**Disco in vetroresina con maniglie per l'allenamento della reattività del portiere sulle deviazioni da tiro o colpo di testa ravvicinato diametro cm.47 peso kg.2**

Fiberglass Discus with handles

for close shot and deflection GK training - diameter 47 cm. weight 2 kg.

pg.7



**Art. 5030.T**

**Telaio con rete in alluminio dim. cm.90x70 ad inclinazione regolabile con maniglie impugnabili dal preparatore.**

**Consente la simulazione di colpi di testa e tiri acrobatici per un allenamento alternativo del portiere**

Aluminium frame with net size 90x70 cm. adjustable inclination with handles for trainer to simulate headers and acrobatic shooting trajectories for new GK exercises



**New!**

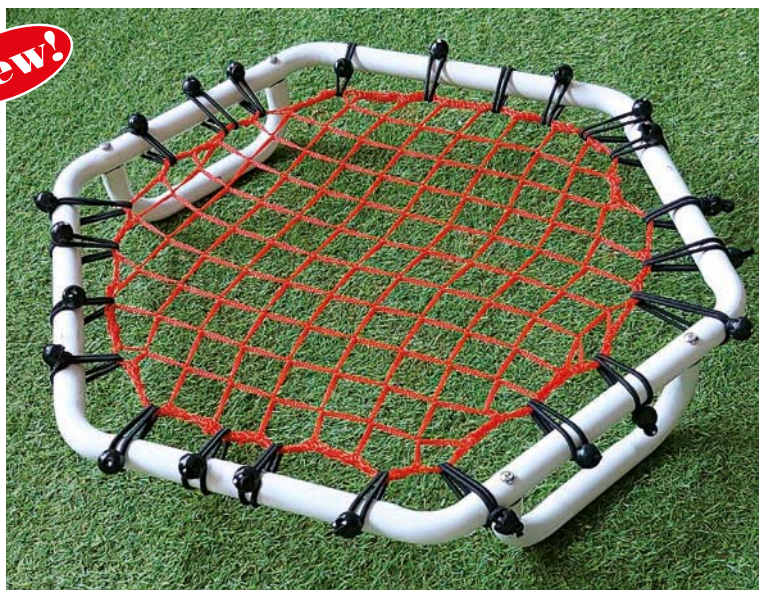

**Art. PTI.5858**

**Telaio con rete esagonale in metallo verniciato dim. cm.65x58 con maniglie impugnabili dal preparatore.**

**Consente la simulazione di colpi di testa e tiri acrobatici per un allenamento alternativo del portiere**

Hexagonal metal frame with net size 65x58 cm. with handles for trainer to simulate headers and acrobatic shooting trajectories for new GK exercises



**Art. 5030**  
**Telaio con rete cm. 130 x 130 in ferro verniciato ad inclinazione regolabile**  
 Painted iron frame with net, dimensions 130x130 cm. adjustable inclination

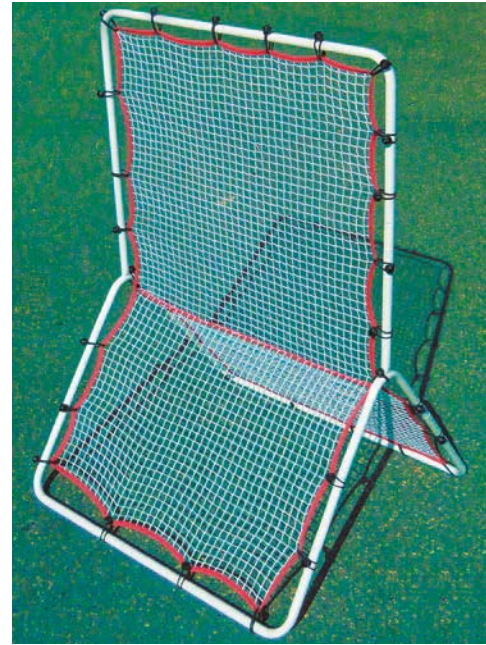

**Art. 503.BF**  
**Telaio con rete in ferro verniciato, bifacciale a doppia inclinazione, altezza cm.150 larghezza cm.100 con picchetti per fissaggio a terra, per allenamento portieri e giocatori**  
 Iron frame with net, in painted iron 2 sides double inclination height 150 cm. width 100 cm. with anchoring hooks for goalkeepers and players

pg.7

**Art. 5035G** Telaio con rete **cm.105 x 105** in ferro cromato ad inclinazione regolabile, per allenamento portieri e giocatori  
 Iron frame with net in chromed iron dimensions 105x105 cm. adjustable inclination for goalkeepers and players

**Prodotto professionale in ferro cromato**  
 Professional in chromed iron



**Prodotto professionale in ferro zincato**  
 Professional in galvanized iron

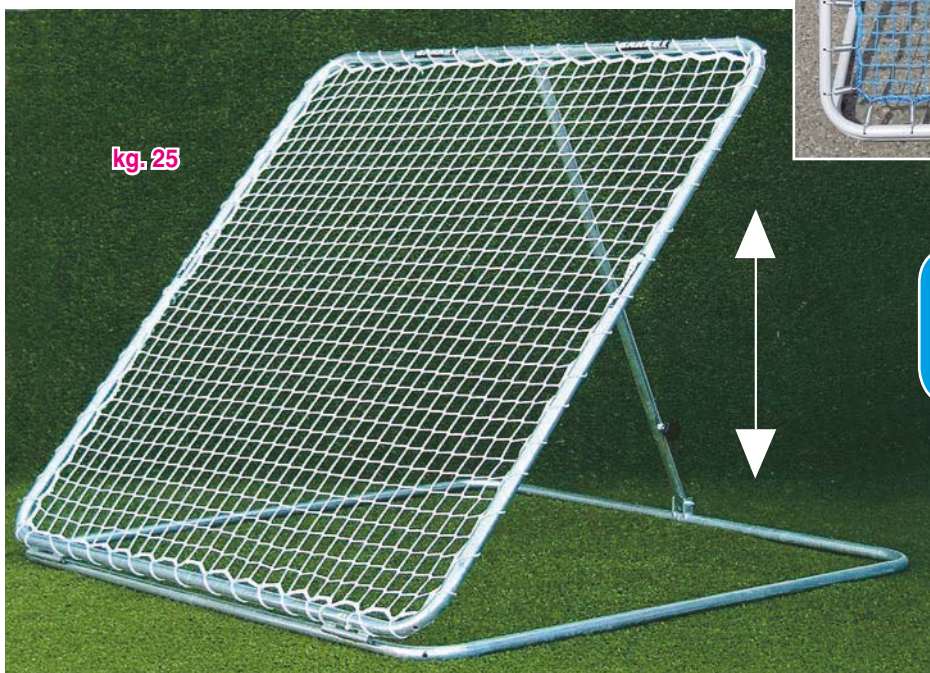

**Art. 5040**  
**Telaio con rete cm. 140 x 140 in ferro zincato ad inclinazione regolabile, per allenamento portieri e giocatori**  
 Iron frame with net in galvanized iron dimensions 140x140 cm. adjustable inclination for goalkeepers and players

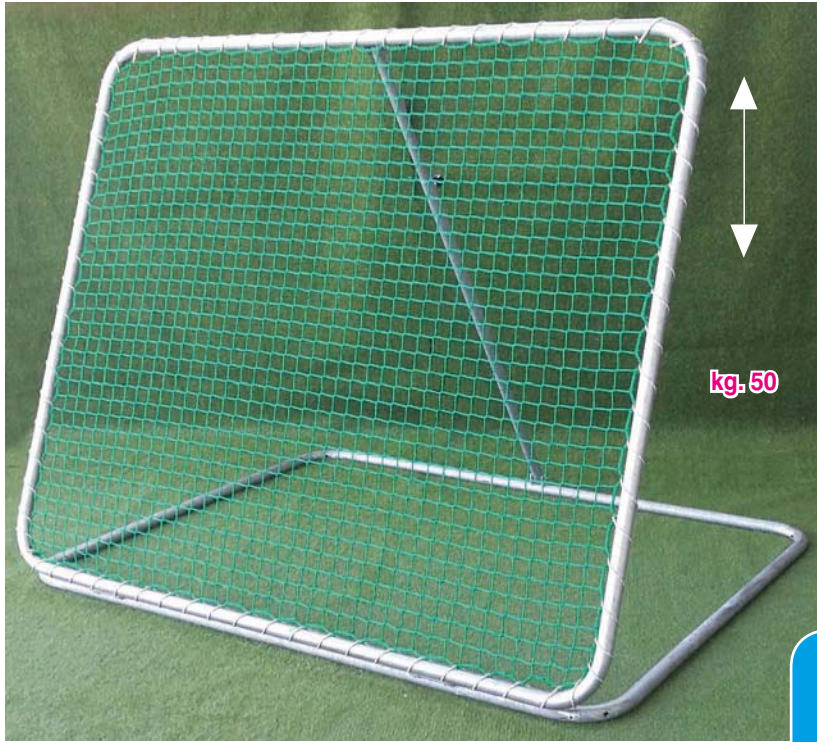

**Art. 50.220**  
**Telaio con rete**  
**cm. 220 x 180**  
**in ferro zincato**  
**ad inclinazione regolabile,**  
**per allenamento**  
**portieri e giocatori**  
Iron frame with net in  
galvanized iron dimensions  
220x180 cm.  
adjustable inclination  
for goalkeepers  
and players

● pg.7

**Prodotti professionali**  
**in ferro zincato**  
Professional in  
galvanized iron



**Art. 5041**  
**Telaio con rete cm. 315 x 230**  
**in ferro zincato ad inclinazione regolabile,**  
**per allenamento portieri e giocatori**  
Iron frame with net, in galvanized iron  
dimensions 315x230 cm.  
adjustable inclination  
for goalkeepers and players

kg. 75



**New!**



**Art. ST441**

**Set 4 ruote con staffa per un agevole**  
**trasporto del telaio Art. 5041 (optional)**  
Set of 4 wheels with bracket for Art. 5041 (optional)





Video dimostrativo disponibile su [www.barretsport.com](http://www.barretsport.com)  
Video available on [www.barretsport.com](http://www.barretsport.com)

**Art. DT01**  
**Deviatore di traiettoria**  
Tubi in alluminio, con cerniere e piedini di stabilità.  
Coadiuvano l'allenamento quotidiano del portiere ed il suo eventuale recupero post traumatico  
**BREVETTATO**  
SHOT DEVIATOR - pipes in aluminium, with hinges and stability pegs - very useful to improve GK reactivity and to accelerate injury recovery  
**PATENTED**

**Brevettato**  
**Patented**

● pg.6

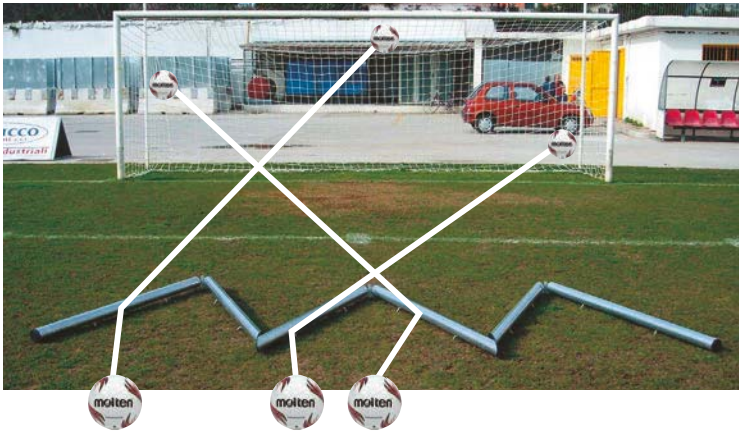

**Borsa per il trasporto inclusa**  
Bag included

Si consiglia di inumidire l'erba di fronte all'attrezzo per incrementare la velocità della palla calciata rasoterra prima dell'impatto con il Deviatore  
We recommend to wet the grass in front of the training device in order to let the ball hit the deviator at a higher speed



Video dimostrativo disponibile su [www.barretsport.com](http://www.barretsport.com)  
Video available on [www.barretsport.com](http://www.barretsport.com)

**Art. BP63**  
**BALL PLAYNING Modello Mundial** - telo in PVC con rilievi gonfiabili e riempiibili con acqua per l'allenamento dei riflessi del portiere metri 5 x 2,5 - completo di borsa e pompa per la gonfiatura  
Ball Playning Mundial for GK training in PVC size 5 x 2,5 meters with air and water bubbles, complete with pump and bag



● pg.6

Prodotto ideato e brevettato da Mario Quaglieri, preparatore portieri professionista



**Bagna il Ball Playning prima dell'uso per incrementare la velocità della palla!**  
Always wet your Ball Playning to increase ball speed!



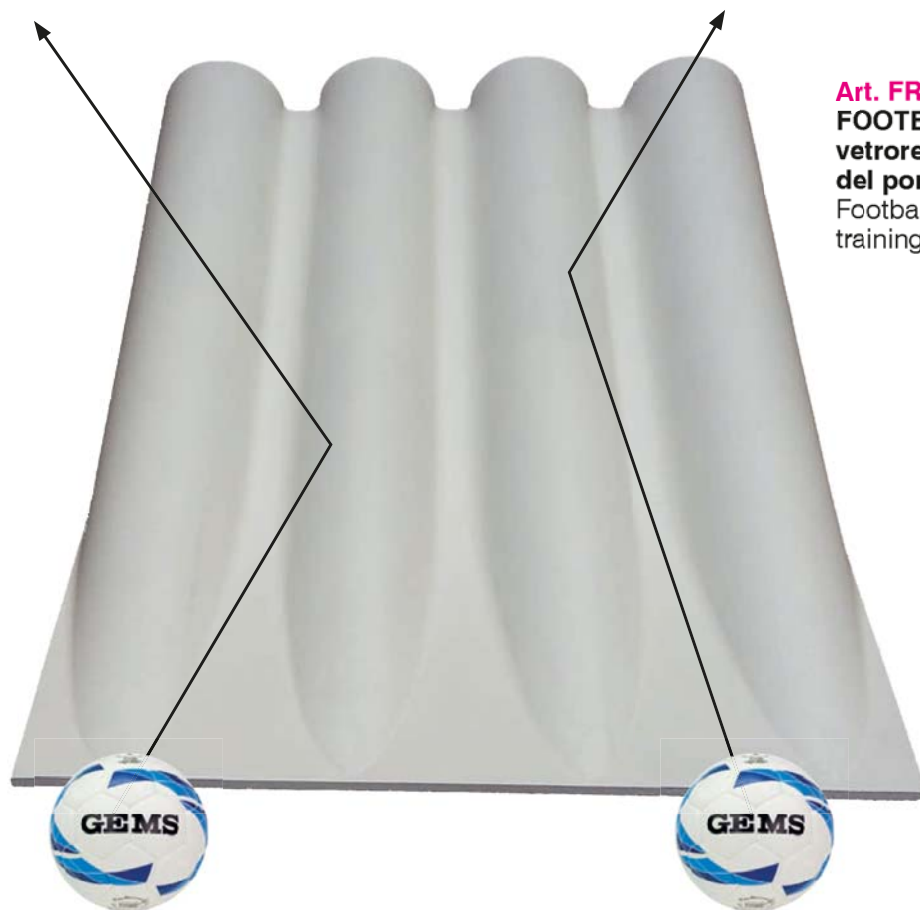

**Art. FRM16**  
**FOOTBALL RAMP - attrezzo in vetroresina per l'allenamento dei riflessi del portiere sui tiri ravvicinati e deviati**  
Football Ramp - fiberglass deviator for GK training to close highly deflected shots

**Bagna il Football Ramp prima dell'uso per incrementare la velocità della palla!**  
Always wet your Football Ramp to increase ball speed!

pg.6

**dimensioni: cm.150x110 ad inclinazione regolabile per mezzo di due piedi telescopici**  
dimensions: 150x110 cm. adjustable inclination by means of two telescopic feet



**Video dimostrativo disponibile su [www.barretsport.com](http://www.barretsport.com)**  
Video available on [www.barretsport.com](http://www.barretsport.com)

pg.6



**Art. BDV15**  
**Cuspide in vetroresina appesantito con cemento, dimensioni cm.56x21x21h per allenamento dei riflessi del portiere**  
Fiberglass cusp with concrete filling dimensions 56x21x21 cm. for GK training

**Posizionando una serie di cuspidi nell'area piccola si ottengono deviazioni della palla improvvise, utili per l'allenamento dei riflessi e della reattività del portiere**  
Train goalkeeper's reactivity to sudden and close deflections by placing a number of cusps near the GK's area





Video dimostrativo disponibile  
su [www.barretsport.com](http://www.barretsport.com)  
Video available on  
[www.barretsport.com](http://www.barretsport.com)

**Art. FRA**  
**FOOTBALL RACK** - attrezzo in ferro  
zincato per l'allenamento dei riflessi del  
portiere sui tiri ravvicinati e deviati  
dimensioni cm.160x54 - peso kg. 13  
Football Rack - galvanized iron deviator  
for training of GK reflexes on close and  
deflected shots  
size 160x54 cm. - weight 13 kg.

pg.6



**Art. FW18**  
**FOOTBALL WAVE** - attrezzo in policarbonato  
per l'allenamento dei riflessi del portiere sui tiri  
ravvicinati e deviati  
dimensioni cm. 90x60 - peso kg. 5  
Football Wave - polycarbonate deviator  
for training of GK reflexes on close and deflected shots  
size 90x60 cm. - weight 5 kg.



**Bagna il Football Wave prima dell'uso  
per incrementare la velocità della palla!**  
Always wet your Football Wave  
to increase ball speed!

**Inclinazione regolabile per mezzo  
di due piedi telescopici**  
Adjustable inclination by means of  
two telescopic feet

**Più Football Waves possono essere posizionati  
contemporaneamente sul terreno per ottenere  
effetti imprevedibili**  
You can place more than one Football Wave on the  
pitch to get unpredictable deflections



## PROPRIOCEZIONE - Equilibrium training



Art. 168PC

**Art. 168PC**  
**Tavoletta propriocettiva in plastica su emisfera, Ø cm. 41 regolabile in altezza**  
 Plastic Equilibrium Board with hemisphere bottom side Ø 41 cm. adjustable height



Art. 168PC

pg.7

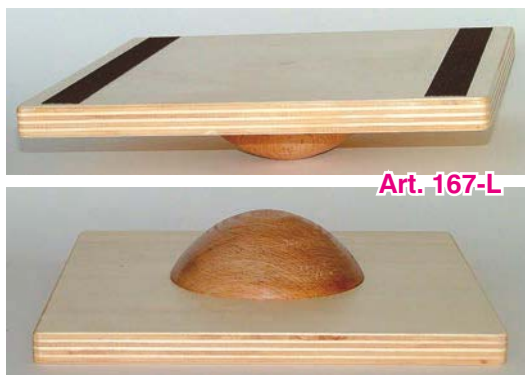

Art. 167-L

**Art. 167-L Tavoletta propriocettiva in legno su emisfera, base di appoggio cm. 30x30**  
 Wooden Equilibrium Board with hemisphere bottom side, base 30x30 cm.



**Art. IS441**  
**Tavoletta propriocettiva in legno su emisfera, con rivestimento antiscivolo Ø cm. 40**  
 Wooden Equilibrium Board with hemisphere bottom side, Ø 40 cm. base with anti-skid surface



Art. 169-R

**Art. 169-R Tavoletta propriocettiva in legno su semiluna, base di appoggio cm.60x40 con rivestimento in gomma antiscivolo**  
 Wooden Equilibrium Board, with half moon bottom side, base dimensions cm.60x40 with anti-skid surface

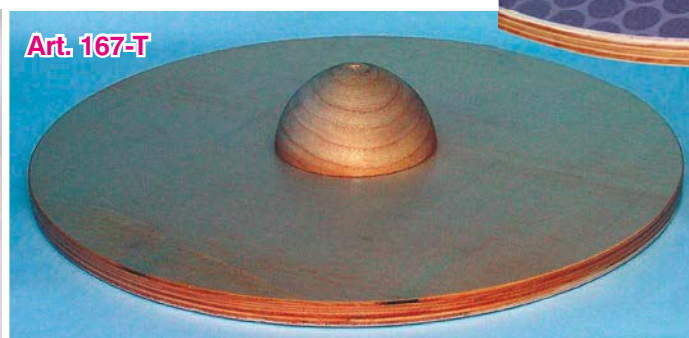

Art. 167-T

**Art. 167-T Tavoletta propriocettiva in legno su emisfera, Ø base di appoggio cm. 60 con rivestimento in gomma antiscivolo**  
 Wooden Equilibrium Board with hemisphere bottom side, base Ø 60 cm. with anti-skid surface



**Art. 169-V Tavoletta propriocettiva in vetroresina su semiluna, base di appoggio cm.60x40**  
 Fiberglass Equilibrium Board, with half moon bottom side, base dimensions 60x40 cm.



**Art. 167-V Tavoletta propriocettiva in vetroresina su emisfera, Ø base di appoggio cm. 60**  
 Fiberglass Equilibrium Board with hemisphere bottom side, base Ø 60 cm.



Velcro  
Velcro

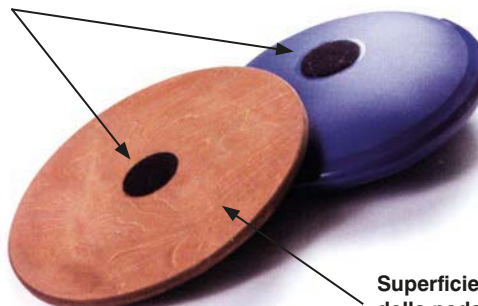

Superficie inferiore  
della pedana in legno  
Lower surface of the  
wooden platform

**Art. 995201 PROPRIO FOOT**  
Tavoletta propriocettiva in legno situata  
su una superficie di appoggio gonfiabile  
Wooden Equilibrium Board  
with inflatable bottom side

pg.7



**Art. 995243 ROLA BOLA** Tavola per l'allenamento dell'equilibrio  
con superficie antiscivolo - i fermi di sicurezza impediscono al cilindro di scivolare all'esterno  
Wooden Equilibrium Board with anti-skid on top  
The cylinder never slips out of the board thanks to the security wood pieces on bottom side

pg.7



**Art. AIR.OC**  
Air step gonfiabile completo  
di maniglie con elastici  
(ad esaurimento scorte)  
Inflatable Air Step  
handles and elastics included  
(until available in stock)



**Art. TBEFS**  
BLOCCO PER STRETCHING tendineo e muscolare  
(flessori caviglia e coscia, dorso etc.)  
con appoggio soffice e sagomato a 2 inclinazioni  
ideale per il defaticamento e per il recupero  
STRETCHING BLOCK for ankle, leg, back muscles and  
tendons - with soft double inclination  
very good for after-training exercises

pg.8



**Art. MH9T / MH16T** Semisfera gonfiabile Trial per riabilitazione e stimolazione propriocettiva diam. cm. 9 o cm. 16  
Inflatable hemisphere for rehabilitation Ø 9 or 16 cm.



**Art. FTN-DB**  
Cuscino gonfiabile puntinato Ø cm 32,5  
Inflatable cylinder for rehabilitation Ø 32,5 cm.



**Art. FY8911**  
Cuscino gonfiabile puntinato Ø cm 39  
Inflatable cylinder for rehabilitation Ø 39 cm.

pg.7



**Art. C1**  
Pedana Cilindrica gonfiabile Trial Skimmy per riabilitazione e stimolazione propriocettiva dim. cm.32,5x6  
Inflatable cylinder for rehabilitation dim. 32,5x6 cm.



**Resistenti ai tacchetti**  
Stud proof



**Art. C2**  
Pedana Cilindrica gonfiabile Trial Super Skimmy per riabilitazione e stimolazione propriocettiva, dim. cm.40x9  
Inflatable cylinder for rehabilitation dim. 40x9 cm.



**Art. C3**  
Pedana Trial Super Skimmy Professional con spalla rinforzata per riabilitazione e stimolazione propriocettiva, gonfiabile cm.40x9  
Inflatable cylinder 40x9 cm. reinforced on sides

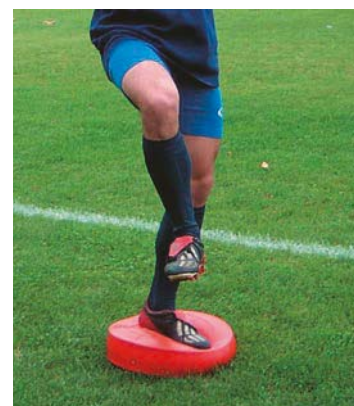



**Art. C11**  
**Pedana Rotante 1**  
 dim. cm 32,5x6  
 kg 2,8  
 (inclusa pompetta  
 per la gonfiatura)  
 Rotatory disk 1  
 pump included



**Art. C22**  
**Pedana Rotante 2**  
 dim. cm 40x10  
 kg 4  
 (inclusa pompetta  
 per la gonfiatura)  
 Rotatory disk 2  
 pump included



**Le Pedane Rotanti Trial, grazie al particolare meccanismo rotante, consentono di creare un'infinita varietà di esercizi basati su diverse posizioni di appoggio e modalità di movimento, utili a stimolare contemporaneamente il sistema vestibolare e quello visivo sensoriale, agendo quindi su tutti i sistemi di controllo del movimento sia a livello nervoso centrale che su quello spinale medio e periferico**

Rotatory Proprioceptive Disks Trial, given the particular rotating mechanism, allow a great variety of exercises based on different positions and motions, useful to simultaneously stimulate the vestibular and the sensory visual systems at both central and spinal/peripheral nervous levels

pg.7

**Art. C4**  
**Rebound Disk - diametro cm.40**  
**altezza cm.4 - Kg.1,5 colore rosso**  
 40 cm. diameter - 4 cm. thick - 1,5 Kg.

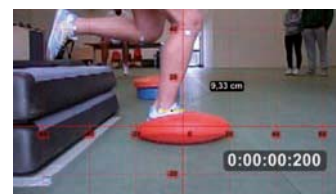
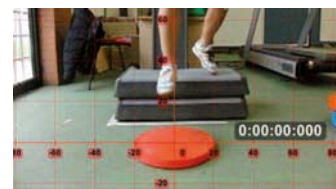

**Rebound Disk Trial è una nuova pedana ideale per allenare contemporaneamente la forza muscolare e la propriocezione. È adatta sia all'uso indoor che outdoor, anche con scarpe tecniche munite di tacchetti. In particolare, con Rebound Disk è possibile sfruttare l'altezza per effettuare esercizi combinati pliometrici (cadute ed ammortizzamento con e senza rimbalzo) e propriocettivi, consentendo all'utente un'esperienza coordinativa e di potenziamento neuromuscolare notevole. Il salto, così come la corsa, è un elemento fondamentale in moltissimi sport come calcio, pallamano, beach-handball, basket, volley, e Rebound Disk è particolarmente allenante per il salto con arresto e cambio di direzione**

Rebound Disk Trial is a new tool ideal to simultaneously train muscle strength and proprioception. It's suitable both for indoor and outdoor utilization, even with technical shoes (with studs). In particular, with Rebound Disk it's possible to exploit one's height for plyometric exercises (fall and dampen with or without rebound) and for proprioceptive ones, and the user is enabled to experience a remarkable coordination and neuromuscular strengthening. Jumping, as well as running, is a basic element in many sports such as soccer, handball, beach-handball, basketball, volleyball, and Rebound Disk is very effective in training jump with stop and direction changes

**Art. T1 Medusa Trial - struttura instabile base Ø cm. 45  
 altezza cm. 23 per riabilitazione e stimolazione  
 equilibrio, in gomma doppio strato  
 massima instabilità**  
 Medusa for rehabilitation  
 and equilibrium training  
 double stratum rubber  
 Ø 45 cm. base  
 height 23 cm.

**Resistente  
 ai tacchetti  
 Stud proof**

pg.8



**Resistente ai  
 tacchetti  
 Stud proof**

**Art. T3  
 Pedana instabile  
 con base inferiore  
 antiscivolo  
 Ø cm. 55  
 altezza cm. 15  
 studiata per  
 i campi sintetici,  
 specifica per  
 i più giovani**  
 Unstable Medusa  
 with anti-skid bottom  
 55 cm. Ø base  
 height 15 cm.  
 ideal for artificial  
 grass and young  
 players

pg.8

**Art. T1.1  
 Medusa Trial Ø cm.45  
 altezza cm. 23  
 con piatto rigido  
 alla base  
 per conferire  
 maggiore stabilità**  
 Medusa 45 cm. Ø base  
 height 23 cm.  
 with rigid bottom for  
 better stability



**Resistente  
 ai tacchetti  
 Stud proof**

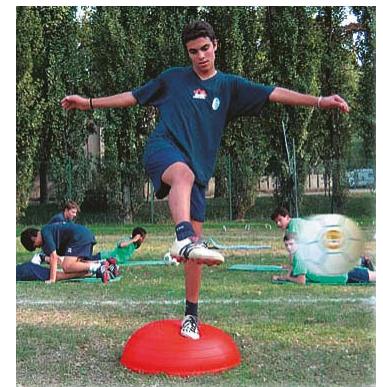

pg.8

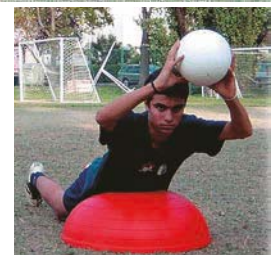

**Art. T2 Tartaruga Trial - struttura instabile base Ø cm. 65 altezza cm. 24  
 per riabilitazione e stimolazione equilibrio, in gomma doppio strato**  
 Medusa double stratum rubber Ø 65 cm. base height 24 cm. - for rehabilitation and equilibrium training



pg.7

**Art. AHF-170**

**Pedana BOSU Ø cm.63 - h. cm.22**  
**ideale per fitness, yoga, pilates**  
**(fino ad esaurimento scorte)**  
 Bosu ball Ø 63 cm. - h. 22 cm.  
 ideal for fitness, yoga, pilates  
 (until available)



**New!**

**Art. BOS**

**Pedana BOSU Ø cm.59 - h. cm.26**  
**ideale per fitness, yoga, pilates**  
**completa di elastici con maniglie e pompa**  
 Bosu ball Ø 59 cm. - h. 26 cm.  
 ideal for fitness, yoga, pilates  
 complete with rubber bands with handles and pump



pg.8



**Art. 14181**

**Fettuccia con lunghezza 18 metri per l'allenamento dell'equilibrio. Si fissa facilmente tra due alberi, ed è perfetta per giocare, allenarsi o fare riabilitazione. Kit completo con sacca e paraalberi**  
 18 meter long tape for balance training. It is easily fixed between two trees and is perfect for playing, training or rehab. Complete kit with bag and tree protections



pg.8



**Art. TCRAZY/TCR.T2**

**CRAZY HORSE**  
**per allenamento di equilibrio "estremo"**  
**da effettuarsi in coppia**  
 For extreme balance training

**Art. TA-I Coppia tappeti propriocettivi ad isole a 2 densità diverse:**

**1 tappeto densità gr. 120 con isole densità gr. 30 - 1 tappeto densità gr. 30 con isole densità gr. 120**  
**dimensioni tappeti m.2x1 moduli con velcro (a formare 1 materasso m.4x1 o m.2x2)**

Pair of Mats 2x1 meter each (when together 4x1 or 2x2 meter):

1 mat 120 gr. density with 30 gr. density round areas, 1 mat 30 gr. density with 120 gr. density round areas

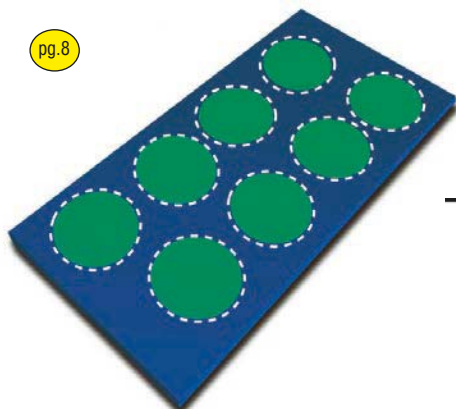

pg.8

**Per riabilitazione post-traumatica, ginnastica dolce, coordinazione e propriocezione**  
**For injury recovery, soft gym, body coordination and equilibrium training**

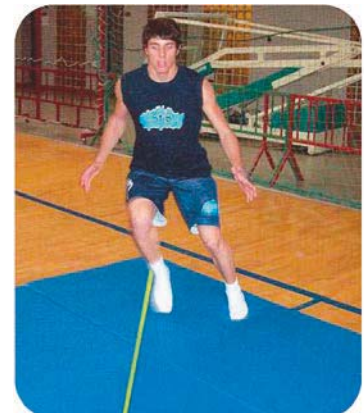



**Art. V9178**  
**Plinto per pliometria regolabile in altezza da cm. 30 a cm. 45 in tubolare di acciaio zincato piano di appoggio in legno multistrato dim. cm.150x30**  
 Plyometric bench adjustable heights (from 30 to 45 cm.) in galvanized steel wooden board dim. 150x30 cm.

pg.10



**Art. 1PP40/2PP40/3PP40/1PP50/2PP50/3PP50**  
**Panca per pliometria in acciaio verniciato, lunghezze disponibili: cm. 100 / cm. 200 / cm. 300 larghezza cm. 35 altezze disponibili: cm. 40 / cm. 50 piano di appoggio in legno rivestito in gomma antiscivolo**  
 Plyometric bench in painted steel, available length 100 / 200 / 300 cm. width 35 cm. available height 40 / 50 cm. board made of wood with anti-skid rubber cover



**Art. AHF-140**  
**Parallelepipedo per pliometria in legno cm. 76x61x51 utilizzabile a 3 diverse altezze**  
 Wooden plyometric box 76x61x51 cm. 3 different heights



**Art. AHF-164**  
**Parallelepipedo per pliometria in legno cm. 76x61x51 con imbottitura in EVA sp. cm. 2 utilizzabile a 3 diverse altezze**  
 Wooden plyometric box 76x61x51 cm. EVA padding 2 cm. thickness 3 different heights



**Art. VCU60 / VCU70 / VCU80**  
**Cubo per pliometria in legno verniciato al naturale con gomma antiscivolo sui piani di appoggio lato cm. 60/70/80**  
 Wooden plyometric cube with anti-skid rubber 60/70/80 cm. side



**Art. PAV2** Set 3 plinti soft a basi rettangolari, sovrapponibili - 3 altezze ottenibili: cm. 30, 60, 90 in gommapiuma rivestita con PVC ignifugo Cl. 1  
 Set of 3 rectangular base soft steps - by placing them one upon the other you can get 3 different heights: 30, 60, 90 cm.



## TRAMPOLINI - Trampolines

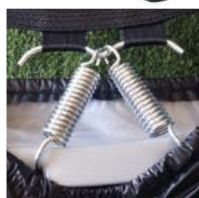

**Art. 166**  
Trampolino elastico Ø cm. 97  
Trampoline Ø 97 cm.

pg.7



**Art. TF-03**  
Trampolino elastico Ø cm. 122  
pieghevole - 40 molle  
Trampoline Ø 122 cm.  
foldable - 40 springs

**Art. V1709**  
Trampolino elastico  
ad altezza fissa  
dim. cm.125x125  
Trampoline 125x125 cm.  
reinforced



**Art. S01154**  
Trampolino elastico  
ad inclinazione  
regolabile  
completo di protezioni  
dim. cm. 125x125  
Trampoline  
size 125 x 125 cm.  
adjustable inclination  
with soft perimetric  
protection

**Art. TRO-9**  
Trampolino da esterno Ø cm. 305  
con rete di protezione perimetrale  
Outdoor trampoline cm. 305 diameter  
with perimetric protection net



## SCALE - CERCHI - CORDE - Speed Ladders - Hoops - Jumping Ropes

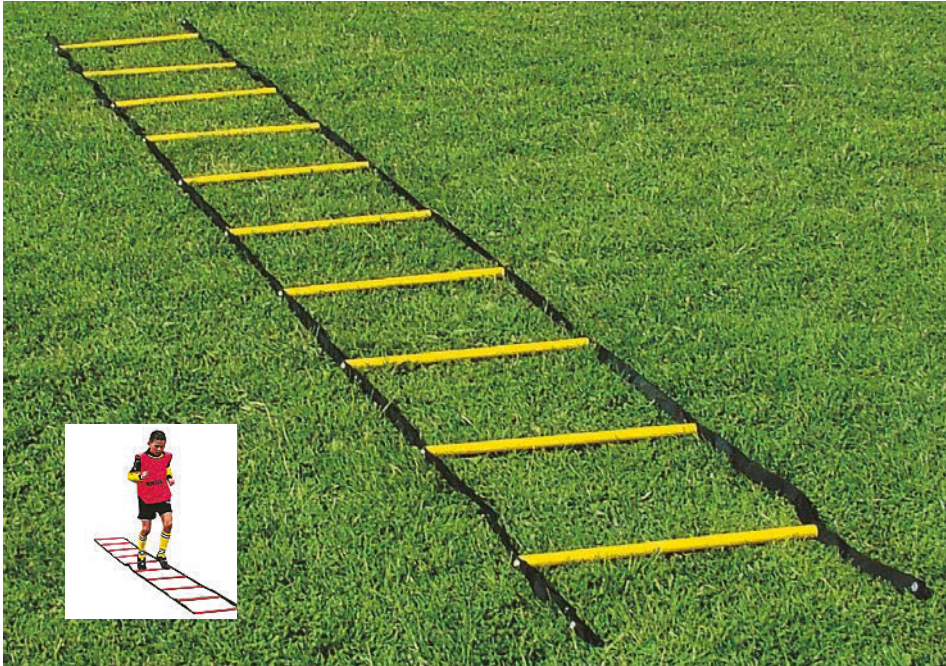

### Art. SL4

Scala lunghezza m. 4  
con 10 pioli rotondi  
per esercizi di  
coordinazione motoria  
(compresa sacca  
per il trasporto)

Speed ladder length 4 meters  
with 10 tubular rungs for quick  
step and coordination  
exercises, bag included

pg.9



### Art. SL4LP

Scala lunghezza m. 4 con 8 listelli piatti  
a distanza regolabile per esercizi di coordinazione motoria  
(compresa sacca per il trasporto)

Speed ladder length 4 meters with 8 adjustable flat rungs  
for quick step and coordination exercises, bag included



### Art. SL6

Scala lunghezza m. 6  
con 12 listelli piatti a distanza regolabile  
(compresa sacca per il trasporto)

Speed ladder length 6 meters  
with 12 adjustable flat rungs,  
bag included

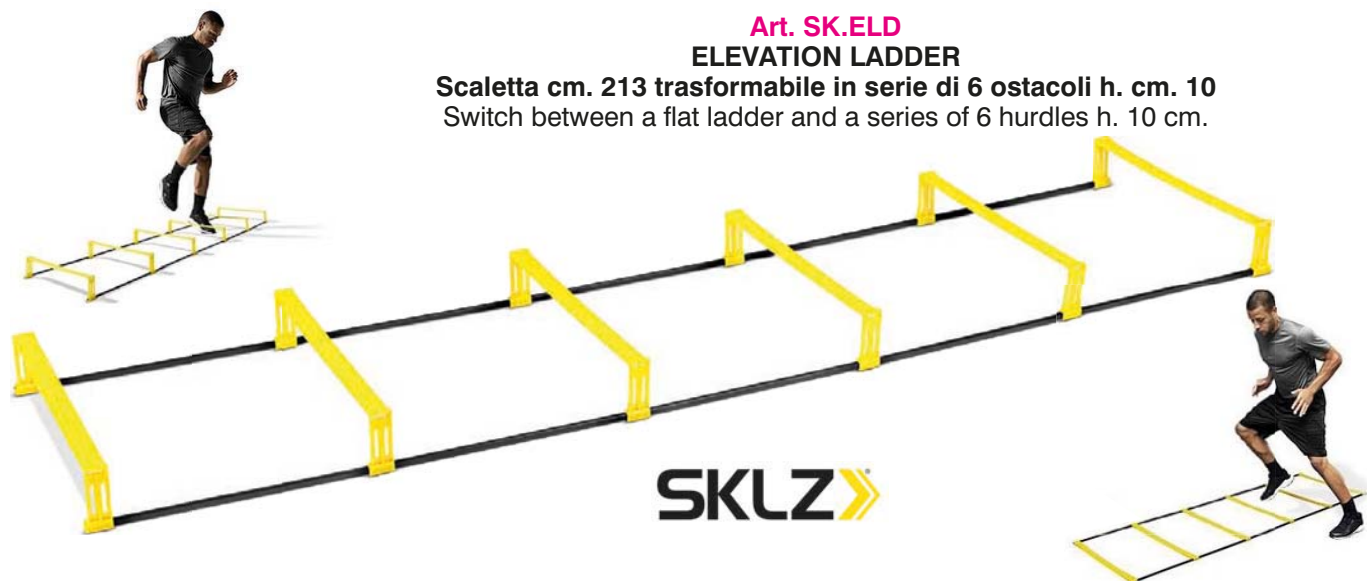

pg.9



**Art. 701411**

**Minibirillo**

**concavo altezza cm. 9  
per sollevamento  
scala Art. B704086**

Cone 9 cm. height carved on  
top for Art. B704086  
underneath support

**Art. K4111**

**Kit scala Art. B704086**

**+ 20 Minibirilli Art. 701411**

**Kit Art. B704086 + 20 x Art. 701411**



**Art. 995215**

**Cor Web da 36 quadri cm. 35x35  
dimensioni totali cm. 465x120  
composto da 13 stecche gialle semirigide  
e 4 strisce in cinghia rossa  
(disponibile fino ad esaurimento scorte)**  
Speed ladder 36 squares 35x35 cm. each  
overall dimensions 465x120 cm.  
(until available in stock)

**Art. 995216**

**Borsa per Cor Web in nylon con cordino e  
stopper per chiusura, con maniglia per il trasporto**  
Bag for Cor Web 36 squares

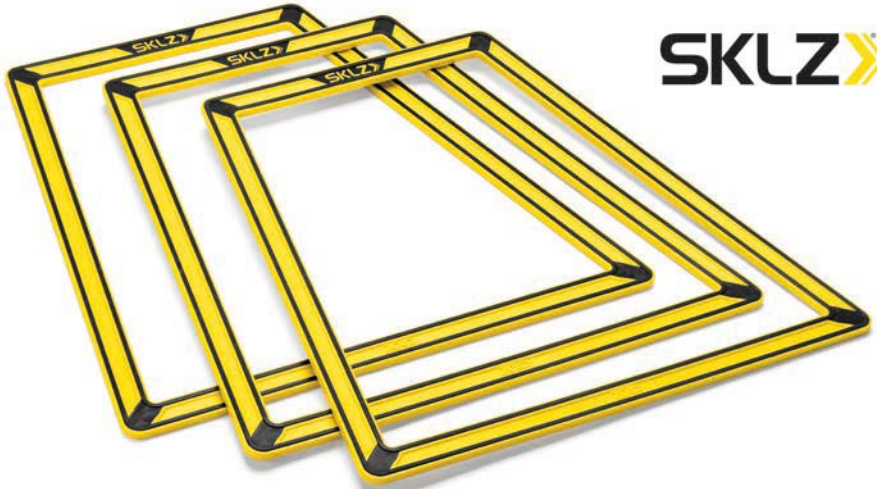

**SKLZ**

**Esempi di combinazioni possibili**  
A few examples

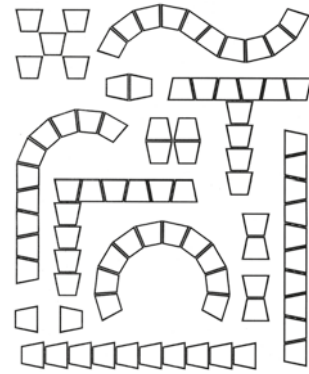

**Art. SK.ATP**  
**AGILITY TRAINER PRO - set 10 TRAPEZI componibili per allenamento agilità e coordinazione multidirezionale, e per il miglioramento della velocità e dei tempi di reazione**

Agility Trainer Pro - customizable footwork and agility trainer designed for curvilinear and alternative training patterns, cuts your reaction time while adding speed in all directions. Set of 10 trapezoids with a carry handle



Con questo nuovo strumento di allenamento creativo si possono incrementare le doti di rapidità, agilità e potenza nei cambi di direzione e nelle traiettorie curvilinee che gli atleti sono chiamati ad effettuare durante la gara. Questi speciali trapezi sono molto stabili su ogni tipo di terreno, permettendo così un esercizio senza interruzioni



Sports don't happen in a straight line, now neither does your training. The Agility Trainer Pro lets you recreate the curvilinear and broken patterns that take place in sports, helping you set up your cuts, turns and changes of direction. It lets you add the multi-directional quickness and precise footwork that can quickly change the game. The Agility Trainer Pro won't slip, slide or otherwise interrupt your training sessions

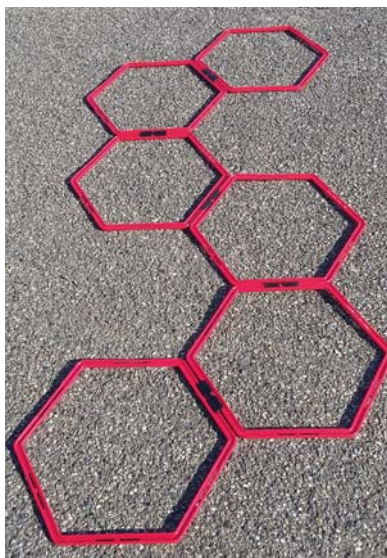
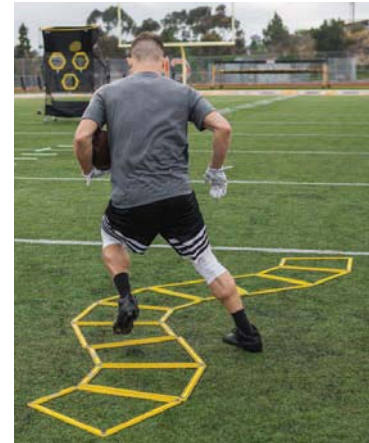

**Art. HEXS6 Set 6 esagoni in plastica componibili dim. cm.45x53 (altezza, larghezza) lato cm.28, completi di clip e borsa colori: giallo, verde, rosso, arancio, azzurro**

Set of 6 modular plastic hexagons 45x53 cm. (height, width) complete with clips and bag - colors: yellow, green, red, orange, royal

**Video dimostrativo disponibile  
su [www.barretsport.com](http://www.barretsport.com)  
Video available on  
[www.barretsport.com](http://www.barretsport.com)**



**Art. SQ15.NS**  
**Set 6 elastici con  
velcro di ricambio**  
Set of 6 spare elastics  
with velcro



**Art. SQ15**  
**15 SQUARES**  
Telaio di cm. 300x200  
in alluminio Ø mm.32  
6 elastici con velcro consentono  
di formare 15 quadri per esercizi di  
coordinazione, reattività, riscaldamento  
e potenziamento muscolare  
con piedi di sostegno intercambiabili  
utilizzabile alle seguenti altezze  
dal terreno: cm.0 / cm.20 / cm.40 / cm.60  
kit completo di borsa per il trasporto  
e di 6 elastici di ricambio (che consentono eventualmente  
di formare un numero maggiore di quadri)

Aluminium frame 300x200 cm. pipe Ø 32 mm.  
equipped with 6 elastic bands with velcro forming 15 squares for  
warm up, coordination, reactivity and jumping exercises  
with interchangeable sets of support feet adjustable at the following  
heights from ground: 0 cm. / 20 cm. / 40 cm./ 60 cm.  
with carrying bag and 6 additional spare elastics  
(which eventually allow you to form  
a greater number of squares)

pg.9



**Morbidi elastici  
flessibili fino  
a terra**  
Soft elastic  
bands  
flexible down  
to the ground

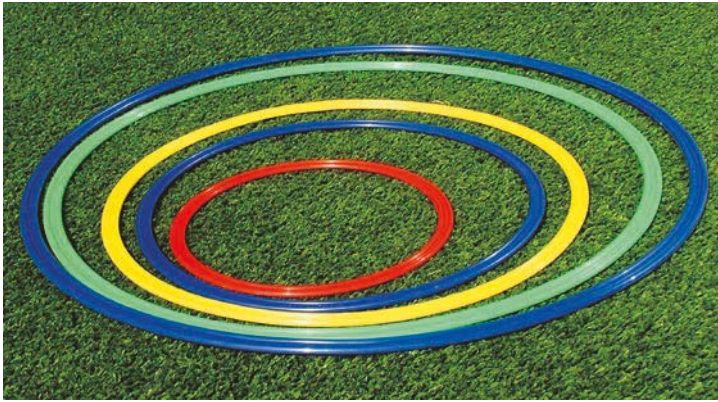

**Art. CNP30 / CNP40 / CNP50 / P00181 / P00191 / P00201**  
**Cerchio in nylon piatto** Ø cm. 30 / 40 / 50 / 60 / 70 / 80  
 Flat Nylon Hoop Ø 30 / 40 / 50 / 60 / 70 / 80 cm.  
 4 colori - 4 colors



**Art. P00182 / P00192 / P00202 / P00212**  
**Cerchio in PVC tubolare**  
 Ø cm. 60 / 70 / 80 / 90 colore rosso o giallo  
 Tubular PVC hoop  
 Ø 60 / 70 / 80 / 90 cm. red or yellow color

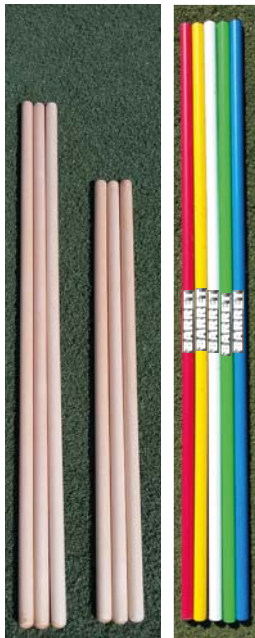

**Art. S00402/S00405**  
**Bastone in legno**  
 cm. 80-100  
 80-100 cm. Wooden Stick

**Art. E21**  
**Bastone in PVC cm.120**  
 120 cm. PVC Stick

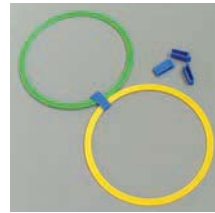

**Art. OCC11**  
**Connettore per cerchi piatti**  
 Flat Hoop Connector



**Art. S00472**  
**Mensola porta cerchi a parete in acciaio verniciato**  
 Hoop wall Holder in painted steel

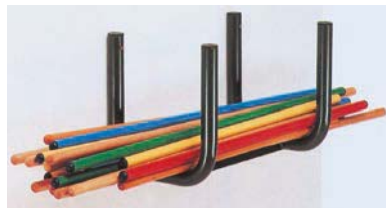

**Art. S00414**  
**Mensola porta bastoni a parete in acciaio verniciato**  
 Stick wall Holder in painted steel

pg.8

**Art. 043P**  
**Corda per salto in nylon con manici in legno**  
 Nylon Skipping Rope with hardwood handles



**Art. 043**  
**Corda per salto in canapa con manici in legno ed ingrossamento centrale**  
 Hemp Skipping Rope with hardwood handles, thicker in the middle section



**Art. AHF-017**  
**Corda per salto in PVC con manici soft touch e cuscinetti a sfera**  
 PVC Skipping Rope with soft handles and ball bearings



**Art. CS1**  
**Corda per salto in canapa con ingrossamento centrale senza manici**  
 Hemp Skipping Rope thicker in the middle without handles

**Art. AHF-102**  
**Corda per salto veloce in acciaio con manici in plastica e cuscinetti a sfera (lunghezza regolabile)**  
 Steel Skipping Rope with plastic handles and ball bearings (adjustable length)



**Art. 043L** Corda per salto in pelle  
 Leather Skipping Rope with hardwood handles



**Art. STAR**  
**Starkick completo di cintura e corda elastica per allenamento ai palleggi ed al tocco di palla (pallone escluso)**  
 Starkick with belt and elastic rope for ball kick and control training (ball not included)



**Art. PTI.15070**  
**Soccer Ball Trainer completo di pallone, corda elastica di m. 12,5 e ancoraggio**  
 Soccer Ball Trainer with ball size 5 in TPU, rubber base, 12,5 m. elastic rope and 1 peg

pg.9



**Art. OTK**  
**Training Kicker con corda non elastica per allenamento ai palleggi ed al tocco di palla (pallone escluso)**  
 Training Kicker with non elastic rope for ball kick and control training (ball not included)



**Art. TIM.SP**  
**Supporto per Tackle Improver**  
 Holder for Tackle improver

**Art. TIM**  
**Tackle Improver per allenamento al contrasto**  
 For tackle training

Uno strumento innovativo per migliorare la tecnica di esecuzione e la potenza del contrasto. Il Tacke Improver indirizza il piede d'appoggio verso la posizione più idonea per esprimere la maggiore potenza d'impatto. Potenzia inoltre tutte le catene muscolari che intervengono nel contrasto, ma senza causare traumi, grazie ad una speciale molla collegata al pistone che sorregge il pallone.

*Very useful training device for strengthening all muscles involved in tackling. Absolutely safe, thanks to a spring and piston system that avoids injuries.*



pg.9



**Art. CVCO**  
**Cavigliera Coordinativa con contrappeso, migliora l'equilibrio e l'indipendenza psicomotoria delle gambe, ed in particolare ammorbidisce la gamba dominante migliorandone la sensibilità del piede**  
 Rotating ankle, with weight, to improve equilibrium and leg independence: in particular it softens the dominant leg improving sensibility of the non dominant foot



pg.9

**Video dimostrativo disponibile su [www.barretsport.com](http://www.barretsport.com)**  
 Video available on [www.barretsport.com](http://www.barretsport.com)

## ALLENAMENTO SOTTO CARICO E FUNZIONALE - Training with weights



**Art. ASN**

Cintura in pelle sintetica con velcro completa di corda, catena e moschettoni **di ricambio** per slitta Art. SLD  
Synthetic leather belt, rope and chains spare for Art. SLD



**Art. SLD**

**Art. SLD** Slitta per il miglioramento della capacità di accelerazione tramite il traino a carico variabile completa di cintura in pelle sintetica con velcro, corda e moschettoni (dischi in ghisa non inclusi) Sledge (weights not included) improving acceleration with synthetic leather belt, rope and chains



**Art. CBV**

Cintura in pelle sintetica con velcro **di ricambio** per Art. SLD  
Synthetic leather belt w/velcro spare for Art. SLD

pg.9



**SKLZ**

**Art. SK.SPSC**

**SPEED SAC - sacca di traino con pesi munita di cintura e moschettone utilizzabile anche indoor o su superfici sintetiche**

Improves overall speed and explosiveness, boosts acceleration and stride length. Adjustable weight options for variable resistance portable and versatile to be used anywhere



In dotazione 3 sacchi di capacità Kg. 4,5 da riempire con sabbia  
Includes 3 x 4,5 Kg. sacs to be filled with sand



pg.8



**Art. 045**

**Giubbino caricabile con pesi fino a Kg.10 (pesi inclusi)**  
Jacket Weighted up to 10 Kg. (weights included)



pg.9

**Art. PCH**

**Paracadute per potenziamento della corsa**  
Parachute to improve the power of your run





**New!**

**Art. BB5D/BB8D/  
BB12D/BB17D**  
**Shoulder Bag**  
con 3 impugnature  
pesi disponibili  
Kg. 5-8-12-17  
Shoulder Bag with  
3 handles  
weights available  
5-8-12-17 Kg.

pg.8



**Art. TBB2 / ... / TBB6**  
**Body Bar**  
Kg. 2-3-4-5-6 per  
allenamento funzionale  
con pesi liberi  
Body Bar  
2-3-4-5-6 Kg.  
for functional training  
with free weights

pg.12



**Art. PBG-5N/PBG-10N/PBG-15N  
PBG-20N/PBG-25N**  
**Borsa Zavorrata**  
con 6 impugnature  
pesi disponibili Kg.5-10-15-20-25  
Heavy Bag with 6 handles  
weights available 5-10-15-20-25 Kg.

pg.8

pg.9

**Art. BGZ**  
**Borsa Gonfiabile zavorrata con acqua a peso variabile**  
(capacità massima 12 litri) cm. 85 con 4 maniglie  
consente nuovi esercizi di forza coordinata  
grazie alla massa oscillante interna  
Inflatable Bag with water inside (maximum 12 liters), length cm. 85  
with 4 handles allows new exercises for muscle strength thanks to  
the dynamic weight inside



**Art. V5083**  
**Pedana di salto in tubo in acciaio dim. cm. 100x100**  
con elastico rigido a tensionamento uniforme  
e dinamometro, cintura e moschettoni  
(dischi in ghisa non inclusi)  
Jump Platform in painted steel dim. 100x100 cm.  
with elastic rope and dynamometer, belt and snap-hooks  
(weights not included)

pg.9



**Art. BR-3812 / BR-5015**  
**Fune da allenamento**  
**Battle Rope**  
ø mm 38 lunghezza mt. 12  
oppure  
ø mm 50 lunghezza mt. 15  
Battle Rope  
12 meters - 38 mm. thick or  
15 meters - 50 mm. thick

pg.9



**In poliestere intrecciato con impugnature rivestite in gomma termoretraibile**  
ideale per il potenziamento dei muscoli di spalle e avambracci,  
ottimo allenamento cardiorespiratorio  
Polyester encased rope with shrink-wrap handles, perfect for strengthening shoulders  
and forearm muscles, excellent cardio-respiratory workout

## FUNCTIONAL TRAINING



pg.9

**FT.IST**  
**Functional Training**  
**Attrezzo polifunzionale**  
**per il potenziamento della catena estensoria**  
**e flessoria degli arti superiori e inferiori**  
 Functional Training multi-purpose  
 belt for the enhancement  
 of the extension and flexion muscular  
 chains of the upper  
 and lower limbs



**FST-DBL**

**Functional Training Double Pro**  
**Attrezzo professionale per allenamento**  
**in sospensione con maniglie svincolate**  
**utilizzabili separatamente**  
 Functional Training with free handles to be used also  
 separately - steel snap hooks and rings



**MTLTX**  
**Lacci di Trazione**  
 Traction Laces

pg.9

**PLTRZ**  
**Prolunga**  
**per Lacci**  
**di Trazione**  
 Extension for  
 Traction Laces



**Attrezzo polifunzionale per il potenziamento della catena estensoria e flessoria degli arti superiori e inferiori**  
 Multi-purpose belt for the enhancement of the extension and flexion muscular chains of the upper and lower limbs



**Art. DTL15**  
**Lacci di Trazione**  
**dinamici**  
**con carrucola**  
 Dynamic functional  
 training with pulley

## BANDE ELASTICHE - BOA - Elastic Bands



**Art. IFBG**  
Fitness band colore giallo  
yellow  
cm. 175x15

**Art. IFBR**  
Fitness band colore rosso  
red  
cm. 175x15

**Art. IFBB**  
Fitness band colore blu  
blue  
cm. 175x15

**Art. IFBN**  
Fitness band colore nero  
black  
cm. 175x15



**Art. 991707 / 991708 / 991709**  
**SET 10 ELASTICI AD ANELLO**  
colore giallo (morbido) - rosso (medio)  
verde (resistente) Ø cm. 27,50  
Elastic Rings yellow (soft) - red (medium)  
green (hard) 27,5 cm. Ø



**Art. AHF-141**  
**Coppia maniglie per fitness band**  
Pair of handles for fitness band

pg.11

**Art. AHF-251/AHF-128/AHF-129**  
**AHF-130/AHF-131/AHF-132**

**Elastico ad anello POWER BAND**  
circonferenza cm. 208 spessore mm. 4,5  
larghezza giallo mm. 6,4 - rosso mm. 13 - nero mm. 22  
viola mm. 29 - verde mm. 45 - blu mm. 64  
Power Band elastic circumference cm.208 - 4,5 mm. thick  
yellow 6,4 mm. width - red 13 mm. width  
black 22 mm. width - violet 29 mm. width  
green 45 mm. width - blue 64 mm. width



**Art. RLEV**  
**Rotolo lattice verde per esercizi muscolari,**  
larghezza cm. 15, lunghezza mt. 25  
spessore 0,3 mm.  
Elastic green Band for muscle exercises,  
15 cm. wide, 25 meter long, thick 0,3 mm.

pg.11

**Art. RLEF**  
**Rotolo lattice fucsia per esercizi muscolari,**  
larghezza cm. 15, lunghezza mt. 25  
spessore 0,4 mm.  
Elastic fuchsia Band for muscle exercises,  
15 cm. wide, 25 meter long, thick 0,4 mm.



**Art. RLEB**  
**Rotolo lattice blu per esercizi muscolari,**  
larghezza cm. 15, lunghezza mt. 25  
spessore 0,5 mm.  
Elastic blue Band for muscle exercises,  
15 cm. wide, 25 meter long, thick 0,5 mm.



**Art. AHF-068**  
**Set 3 elastici tubing con maniglie**  
tre differenti livelli di resistenza  
impugnature ergonomiche soft touch  
per esercizi arti superiori e inferiori  
completo di borsa in microrete  
Set 3 elastics with handles  
3-level resistance - soft touch handles,  
bag included - tones and strengthens  
arms, legs, gluteus, abdominals,  
shoulders and chest muscles



**Art. KER-IS**

Set 5 elastici con 5 diverse resistenze dotati di ganci metallici da entrambi i lati. Completo di 1 coppia di maniglie, 1 coppia di cavigliere, 1 accessorio per bloccare l'elastico contro una porta e utilizzare un arto per volta, 1 sacca

Set of 5 elastic bands with 5 different resistances equipped with metal hooks on both sides. Complete with 1 pair of handles, 1 pair of ankle bands, 1 accessory to lock the elastic against a door and use one limb at a time, 1 bag

Here are some examples of the door anchor in action:

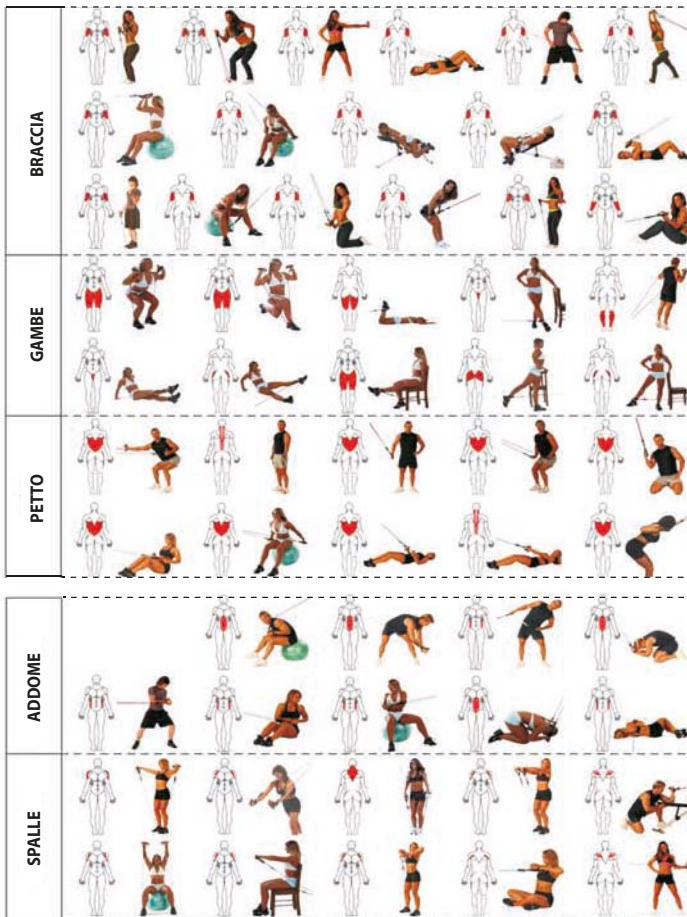

COLORE ELASTICO	LIVELLO DI RESISTENZA	LIVELLO DI RESISTENZA	DIMENSIONI
GIALLO	EXTRA LEGGERO	2,7 kg - 3,6 Kg	5X8X1100MM
VERDE	LEGGERO	4 kg - 5 Kg	6X9X1100MM
ROSSO	MEDIO	5,5 kg - 6,75 Kg	5X9X1100MM
BLU	FORTE	6,75 kg - 9 Kg	5X10X1100MM
NERO	EXTRA FORTE	9,45 kg - 11,25 Kg	6X11X1100MM

1. Your resistance bands come in 5 different resistance levels, noted by a different band color. Please refer to the table for more information on the levels of resistance
2. You can use any or all of the bands at one time during your workouts
3. Attach one end of the band(s) to the foam handles or ankle straps and same on the other end
4. The door anchor will attach anywhere on a standard door, including the bottom of the door. To use the door anchor, ensure the bigger end is attached to the apposite side of door and feed the thin end through. Once the thin end is through you can feed the exercise band through it. Ensure the door is fully closed before performing any exercise

pg.11

Resistance Band Color	Resistance level	Resistance level	Dimensions
Yellow	X - Light	6lbs - 8lbs	5X8X1100MM
Green	Light	9lbs - 11lbs	6X9X1100MM
Red	Medium	12lbs - 15lbs	5X9X1100MM
Blue	Heavy	15lbs - 20lbs	5X10X1100MM
Black	X-Heavy	21lbs - 25lbs	6X11X1100MM

**Art. 991710/ ... /991738**

Elastico tubing con maniglie colore rosso, giallo, viola, nero  
Elastic with handles  
red, yellow, violet, black color



**Art. 991714/ ... /991742**

Elastico tubing mt.10 senza maniglie colore rosso, giallo, viola, nero  
10 meter elastic without handles  
red, yellow, violet, black color

**Art. 016824**

**ELASTICO BOA in gomma para mm. 7x18 rivestito con guaina di sicurezza lunghezza mt. 3 con un moschettone a ciascuna estremità, resistenza Kg. 50**

Rubber BOA 7x18 mm. with safety sheath 3 meter length, resistance 50 Kg.

pg.10 pg.11



**Art. 016827**

**Paio polsini per elastico BOA**

Pair of wristbands for BOA exercises



**Art. 016824**  
**ELASTICO BOA**

**Art. 016826**  
**CINTURA Senior**

Si suggerisce l'utilizzo dell'elastico BOA con una cintura o con un altro tra gli accessori disponibili

Utilization of rubber Boa is suggested with a belt or with another available accessory



**Art. 016828**

**Paio cavigliere per elastico BOA**

Pair of anklebands for BOA exercises

**Art. 016825**

**CINTURA Junior da agganciare a elastico BOA diametro max cm.105**

Junior Belt for BOA traction - max diameter 105 cm.

**Art. 016826**

**CINTURA Senior da agganciare a elastico BOA diametro max cm.140**

Senior Belt for BOA traction - max diameter 140 cm.

pg.11



**Art. 016829**

**Pettorina per elastico BOA**

Shoulder belt for BOA exercises



**Art. C3005**

**Staffa per ancoraggio elastico BOA a parete**  
BOA wall anchor bracket



Anello scorrevole  
"free-floating" ring



**SKLZ**

**Art. SK.R360**

**RECOIL 360 - elastico con cintura ad anello scorrevole utilizzabile in autonomia o con l'aiuto del preparatore resistenza Kg. 22**

Maximizes power, speed and vertical jump Engineered with a "free-floating" ring for 360 degrees of movement

Designed for solo use or for training with a partner resistance 22 Kg.

pg.11

**DYNAMIC RESISTANCE / ASSISTANCE TRAINER**



**Art. SK.ACTR**

**ACCELERATION TRAINER**

per l'allenamento della velocità in ogni direzione,  
dell'accelerazione e della velocità massima

Da utilizzare con l'aiuto del preparatore

Trains speed in every direction

Builds speed and power from the start,  
during acceleration and at the top-end

Designed for training with a partner



pg.10

**DYNAMIC OVERLOAD AND RELEASE SYSTEM**



Anello scorrevole  
"free-floating" ring



**Art. SK.LRP**

**LATERAL RESISTOR PRO**

Attrezzo per migliorare la velocità del primo passo  
e la rapidità laterale con elastici tubolari  
intercambiabili a diversa resistenza

Develops first-step quickness and lateral speed

Patented Slide-Lock system for quick, safe  
switching of resistance cables



**STRENGTH AND SPEED TRAINER**



pg.10

**VERTICAL JUMP TRAINER**



**Art. SK.HPZ**

**HOPZ 2.0**

Attrezzo per migliorare la forza e la potenza dei muscoli  
impegnati nell'elevazione, con elastici tubolari  
intercambiabili a diversa resistenza

Builds explosive leg power and strengthens jumping muscles

You can move resistance cables on belt to target specific  
muscles and change resistance cable quickly





**Art. PTI.SPS**

**Slide Pads - paio di slide pads utilizzati per esercizi di scivolamento di mani e piedi volti al miglioramento della flessibilità e della forza muscolare**  
Set of 2 pcs. - simulates many slide board exercises - conditioning tool to improve flexibility, shaping and core strength



pg.11

**Art. PTI.STR**

**Slide Trainer - lunghezza cm.140 con 2 scarpette con velcro per lo scivolamento**  
Utile strumento per sviluppare la forza laterale, la potenza, la resistenza, l'equilibrio, l'agilità, la velocità e la flessibilità  
Slide Trainer length 140 cm. with 2 gliding shoes great for developing lateral strength, power, endurance, balance, agility, speed and flexibility



pg.10



**Art. AKHF**

**Kit Home Fitness comprendente rinforza spalle, sistema carrucolare, bastone estensibile, Antonelast uomo, Antonelast donna**  
Kit includes shoulder strengthener, extensible stick, Antonelast for man and Antonelast for woman

**Art. ARS.3 Banda Elastica rinforza spalle - può essere usata in ogni luogo che abbia un appiglio per la chiusura a velcro (anche in casa o in albergo) grazie alla presenza di uno spessore che, a porta chiusa, non fa scivolare l'attrezzo e non danneggia la porta**  
Elastic Band for shoulder injury training exercises



**Art. 05021456**  
**JUMP-TRAINER**

Strumento di allenamento per migliorare la potenza nel salto. Adatto a portieri e giocatori. Un atleta indossa la cintura regolabile con velcro, mentre due compagni di allenamento trattengono le fasce elastiche salde a terra - lunghezza delle fasce elastiche m. 1,20 ciascuna (in posizione di riposo)

Training tool to improve jump power. Suitable for goalkeepers and field players. One player puts on the adjustable hip belt with velcro fastener, two training partners hold the elastic bands on the ground using their feet. Length of elastic side bands (not stretched) 1,20 m.

pg.10



Da utilizzare solo con porte fisse  
To be used only with fixed goals

**Art. 05021320**

**GOALKEEPER TRACTION BELT**

Cintura con elastici intercambiabili per allenamento del portiere. Modificando la composizione degli elastici fissati alla base dei pali si ottengono 8 diversi tipi di resistenza (leggera, media, medio-alta, alta)

Belt with elastics for goalkeeper training.

By switching bungee ropes and connecting them to each other and to the belt in different ways, you get 8 different combinations for low, medium, medium-high, high resistance



**Art. KAP**

Kit allenamento portiere composto da 10 Antonelast, 1 Cintura, 1 Rinforza adduttori, 4 Anelli fissa bande per il miglioramento della forza esplosiva

Goalkeeper training kit

made of 10 Antonelast, 1 Belt, 1 Abductor muscle band, 4 connecting rings to improve explosive muscular strength and goalkeeper's jumps and dives

pg.10





**Art. AE**  
**Banda elastica**  
**Antonelast**  
**per esercizi di**  
**stretching e**  
**potenziamento**  
**muscolare**  
 Elastic band for  
 body muscle  
 exercises



**Con velcro cucito su**  
**entrambe le estremità**  
**with velcro seamed at**  
**both sides**



**Art. RA**  
**Rinforza abduttori**  
 Elastic band for  
 abductor muscles

**Con velcro cucito su**  
**entrambe le estremità**  
**with velcro seamed at**  
**both sides**



pg.10



**Art. OSI**

**Over Speed Improver - Tramite questa cintura elastica l'atleta più veloce trascina il più lento, incrementando contemporaneamente la velocità di entrambi**  
 By this elastic belt the quicker player pulls the slower player, increasing both athletes' speed



**Con velcro cucito su**  
**entrambe le estremità**  
**with velcro seamed at**  
**both sides**



**Art. PSR**  
**Power Speed**  
**Resistor**  
**per potenziamento**  
**della corsa**  
**esercizio in coppia**  
**(nylon non elastico)**  
 To improve explosive  
 force - two people  
 involved (non elastic  
 band)

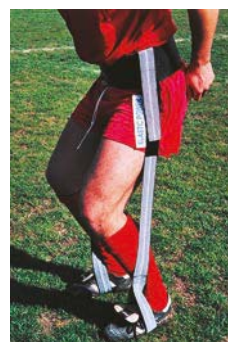

**Art. EPW**  
**Elastic Power**  
**2 fasce con cintura**  
**in pelle**  
**incrementa**  
**la forza esplosiva**  
**potenziando la**  
**muscolatura delle**  
**gambe e del dorso**  
 2 Bands with leather belt  
 for explosive strength  
 improvement, for leg and  
 back muscle training



**Art. SRE**

**Speed Reaction**

**Allenamento dei riflessi e della reattività (l'elastico non si sgancia se il difensore perde contatto dall'attaccante)**

Reflex and reactivity training device (the belt does not separate if the defender loses contact)



**Cintura elastica**  
Elastic belt



**Cintura non elastica**  
Non elastic belt

**Art. EB**

**Evasion Belt - Allenamento dei riflessi e della reattività ideale per marcature a uomo (la cintura si sgancia se il difensore perde contatto dall'attaccante)**

Reflex and reactivity training device, for man to man coverage (the defender loses contact)



**Art. RIM**  
**Reaction Improver**  
per l'allenamento della reazione allo stimolo visivo in percorsi ad ostacoli, ideale per marcature a uomo (l'elastico si stacca se si perde contatto)  
Elastic Belt for visual reflex training in drill sections, for man to man coverage (the elastic separates if following athlete loses contact)



pg.10



**Art. KAT** Kit allenamento tattico composto da 7 bande elastiche di metri 10 ciascuna  
Tactical training Kit made of 7 Elastic bands 10 meter long each

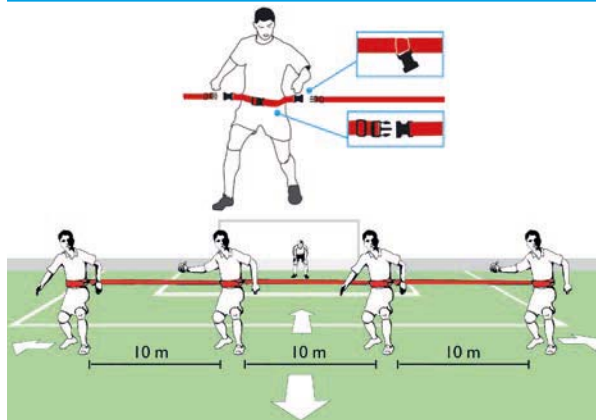

**Art. 05020798**

**Set di 4 cinture con dispositivo di fissaggio e 3 fasce non elastiche lunghe m. 10 ciascuna**

**Con questo prodotto è possibile vincolare quattro difensori allenandone il posizionamento ed i movimenti sul campo**

Set of 4 hip belts with fasteners and 3 unelastic bands 10 m. long each  
With this kit you can connect all four players of your defensive block, training their positioning and movements on the field

**Art. SC010**

**OFFERTA KIT TECNICO SCUOLA CALCIO**

pg.9

Kit così composto: n.15 paletti slalom Art.007  
n. 15 basi ad imbuto Art.018 - n. 1 kit delimitatori Art.016 - n. 6 ostacoli over cm.12 Art.80.12  
n. 2 ostacoli over cm.20 Art.80.20 - n. 2 ostacoli over cm.30 Art. 80.30 - n. 2 ostacoli over cm.40 Art.80.40  
n. 12 corde salto Art.043P - n. 1 scala a pioli Art. SL4 - n. 12 maxidelimitatori h.cm.28 Art.019.1  
n. 12 cerchi piatti diam.cm.50 Art.CNP50 - n. 1 tavoletta propriocettiva in ABS Art.168PC

**SOCCER SCHOOL KIT SPECIAL OFFER**

15 x Art.007 + 15 x Art.018 + 1 x Art.016 + 6 x Art.80.12 + 2 x Art.80.20 + 2 x Art.80.30 + 2 x Art.80.40  
+ 12 x Art.043P + 1 x Art.SL4 + 12(pieces) x Art.019.1 + 12 x Art.CNP50 + 1 x Art.168PC



Art. 80.12/80.20/80.30/80.40



Art. CNP50



Art. 007



Art. 016



Art. SL4



Art. 019.1



Art. 168PC



Art. 018



Art. 043P

## FITNESS BODY-BUILDING

Art. S01108

Art. S01106

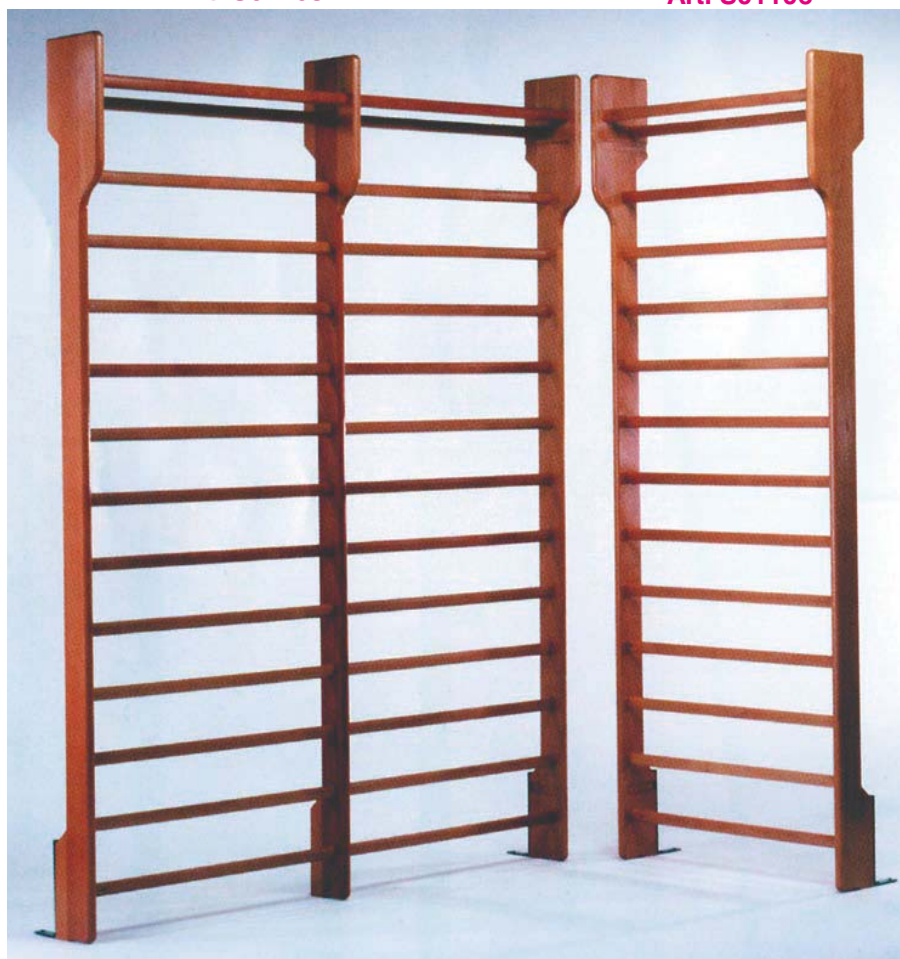

Art. S01106  
Spalliera Svedese  
a 1 campata  
dim. cm. 90x250  
in faggio evaporato  
Swedish Wall Bar 1 span

pg.13

Art. S01108  
Spalliera Svedese  
a 2 campate  
dim. cm. 180x250  
in faggio evaporato  
Swedish Wall Bar 2 spans



Art. S00908  
Panca per addominali imbottita  
agganciabile a spalliera  
Abdominal bench to be fixed to  
Swedish Wall Bar



Art. UNG05 / UNG1 / UNG2 / UNG3 / UNG4 / UNG5  
Coppia Manubri in ghisa rivestiti  
Kg. 0,5-1-2-3-4-5 cadauno  
Pair of Dumb Bells from 0,5 to 5 Kg. each one

pg.12



Art. F301  
Porta manubri in ferro  
Dumb Bell Rack



**New!**

Art. MGED6 / MGED8 / MGED10  
Manubrio esagonale con rivestimento in gomma Kg. 6-8-10  
(fornito singolarmente)  
Hexagonal Dumb Bell with rubber coating 6-8-10 Kg.



**Art. AS196**  
Coppia fermadischi a vite  
Pair of plate holders with thread

pg.11 pg.12

**Art. US176**  
Coppia fermadischi a T  
Pair of T-shaped plate holders



**\*\*Art. US304 / US305**  
Bilanciere cm. 150 / cm. 180  
Ø mm. 25  
Weight bar length 150 / 180 cm.

**\*\*Art. US301** Manubrio a dischi inseribili  
cm. 35 Ø mm. 25  
Hand bar length 35 cm.



**\*\*Fermadischi inclusi**  
Plate holders included  
Carico massimo Kg. 100  
Maximum load 100 Kg.

**\*\*Art. US303**  
Bilanciere sagomato  
cm. 120 Ø mm. 25  
Bar length 120 cm.



**Art. UN640**  
Dischi in ghisa foro mm.26  
Kg. 0,5 - 1 - 2 - 5 - 10  
15 - 20 cadauno  
Cast Iron Weight Plates  
hole 26 mm.



**Art. DGG**  
Dischi in ghisa foro mm.26  
rivestiti in gomma  
Kg. 0,5 - 1 - 2 - 5 - 10 - 15 - 20 cadauno  
Cast Iron Weight Plates hole 26 mm.  
covered with rubber



**Art. US287**  
Coppia fermadischi a molla  
Pair of spring plate holders

**Art. F302**  
Porta dischi in ferro  
Weight Plates Rack



**Art. 17203**  
Paio guanti Lycra  
misure da XS a XL vari colori  
Gym Gloves Lycra



**Art. 30907**  
Paio guanti Premium Pro  
misure da S a XL vari colori  
Gym Gloves Premium Pro



**Art. 17222**  
Cintura Body Building h. cm. 10 - misure da S a XL  
Body Building Leather Belt h. 10 cm.  
sizes from S to XL



**Art. 13382 / 13383 / 13384 / 30937**  
Paio Cavigliere Kg. 0,5 - 1 - 1,5 - 2 cadauna  
Pair of Ankle Weights 0,5 - 1 - 1,5 - 2 Kg. each one



**Art. AHF-093**  
Paio Cavigliere Kg. 2,5 cadauna con pesi estraibili  
Pair of Ankle Weights 2,5 Kg. each  
removable weights



**Art. AHF-026**  
Coppia maniglie per flessioni  
Push-up handles



**Art. AHF-070**  
Estensore  
con elastici  
Chest-Expander



**Art. AHF-161**  
Coppia Parallettes h. cm. 75  
Pair of Parallettes 75 cm. height

pg.12



**Art. AHF-074**  
Coppia sostegni ruotabili  
per flessioni  
Turnable Push-up handles

**Art. AHF-021**  
Coppia Tenaglie stringimano  
con impugnatura soft touch  
Pincers for hand strengthening



**Art. AHF-047**  
Ruota doppia per addominali  
Double Wheel for abdominal muscles



**Art. AHF-157**  
Coppia manubri con ruote  
per addominali  
Pair of dumb bells with wheels  
for abdominal muscles



**Art. AHF-063**  
Contapassi  
(ad esaurimento)  
Step Counter  
(until available)

pg.13



**Art. AHF-064**  
Contapassi multifunzione  
Multi-function Step Counter



**Art. DEAPWR**  
Ministepper a pistoni idraulici con elastici per il potenziamento di braccia, dorso e addome  
Computer a 2 funzioni: tempo, calorie  
Peso massimo utilizzatore 100 kg.  
Ministepper with hydraulic rams and elastic bands for strengthening arms, back and abdomen

pg.12

**Art. OCST**  
Gradino step a 2 altezze (cm. 10-15) con antiscivolo dim. cm. 68x30  
Step 2 heights (10-15 cm.) with anti-skid dim. 68x30 cm.



**Art. WBX-70**  
Power Tower  
Attrezzo multifunzione ideato per l'allenamento intensivo di tutto il corpo senza l'utilizzo dei pesi  
Tubolare a sezione quadrata da 5 cm.  
Peso massimo utilizzatore 120 Kg.  
Multi purpose tool for intensive body training without weights

pg.13



**Art. AHF-003**  
Gradino step regolabile a 3 altezze (cm. 15-20-25) superficie antiscivolo dim. cm. 89x39  
Step adjustable at 3 different heights (maximum height 25 cm.) with anti-skid surface dim. 89x39 cm.



**Art. BTM**  
Barra per trazioni con fissaggio a parete  
Exercise Bar

pg.12



**Art. BTE**  
Barra Entroporta  
Door Bar



**Art. CGF350**  
Panca multifunzione  
telaio in acciaio,  
schienale regolabile  
portata massima kg. 100  
Weight lifting Bench



**Art. CGF450**  
Panca pesi con supporti  
bilanciere, telaio in acciaio,  
schienale regolabile  
peso max utilizzatore kg. 100  
Weight lifting Bench  
with bar holders

ATTENZIONE: questi prodotti sono concepiti esclusivamente per uso home fitness, perciò la garanzia non copre il loro utilizzo presso palestre o centri sportivi



**Art. WBX-85**  
Panca piana/90° Power Bench  
rinforzata (abbinabile con Power Rack)  
Power Bench



pg.13

**Art. GYM1000**  
Stazione Multifunzione  
dotata di torre per dorsali, pressa per  
pettorali, attrezzo per le gambe, vogatore,  
cuscino per bicipiti - carico massimo 60 Kg.  
(pesi inclusi), 15 esercizi praticabili  
Peso massimo utilizzatore 120 Kg.  
Multi purpose machine



**Art. WBX-50**  
Power Rack  
Supporti per bilanciere  
Altezza e larghezza  
regolabili  
Dotato di 2 rimessaggi  
per dischi  
Peso massimo  
caricabile 200 Kg.  
Supports for weight bar



**Art. ELX-1**

Ellittica con manubrio  
e pedali regolabili  
Sistema frenante magnetico  
8 livelli di intensità con  
regolazione manuale  
Pulsazioni Hand Pulse  
Schermo LCD  
Funzioni: tempo, velocità,  
distanza, pulsazioni, calorie,  
recupero, odometro  
Peso massimo utilizzatore 120 Kg.  
Peso del volano 6 Kg.  
Elliptical exercise Bike  
7 function computer



**ATTENZIONE:** questi prodotti sono concepiti esclusivamente per uso home fitness, perciò la garanzia non copre il loro utilizzo presso palestre o centri sportivi



**Art. AHF-165**  
Fascia da braccio  
porta smartphone  
Arm smartphone holder

pg.12



**Art. E680**  
Bracciale porta oggetti  
in neoprene cm.14,5x8x2  
Neoprene arm wallet

**Art. AB-CNH**  
AB Crunch Master  
richiudibile  
AB Crunch Master  
foldable



**Art. GWM13**  
Pedaliera manuale  
utilizzabile da seduti per gli arti inferiori  
e appoggiata sul tavolo per gli arti superiori  
Peso 5 Kg. - con computer  
Intensità sforzo regolabile  
Cycling device for arm and leg exercises

pg.12



**Art. GWE13**  
Pedaliera elettrica  
per la ginnastica passiva  
degli arti inferiori e superiori  
Velocità regolabile  
con telecomando  
Peso 6 Kg. - con computer  
Cycling electric device for arm and  
leg exercises



**Art. BFK-300**

Bicicletta da camera con freno magnetico  
Regolazione dell'intensità manuale a 8 livelli  
Volano da 4 Kg. - Computer a 6 funzioni: tempo, velocità, distanza, calorie, scan, pulsazioni con sensori Hand Pulse  
Peso massimo utilizzatore 100 Kg. - Peso dell'attrezzo 20 Kg.  
Cyclette Magnetic with 6 function computer

pg.12

pg.13

**ATTENZIONE:** questi prodotti sono concepiti esclusivamente per uso home fitness, perciò la garanzia non copre il loro utilizzo presso palestre o centri sportivi



**Art. BRX-60**

Bicicletta da camera con freno magnetico  
Regolazione dell'intensità manuale a 8 livelli  
Volano da 7 Kg. - Computer a 6 funzioni: tempo, velocità, distanza, calorie, odometro, pulsazioni con sensori Hand Pulse  
Peso massimo utilizzatore 110 Kg.  
Peso dell'attrezzo 24 Kg.  
Cyclette Magnetic with 6 function computer

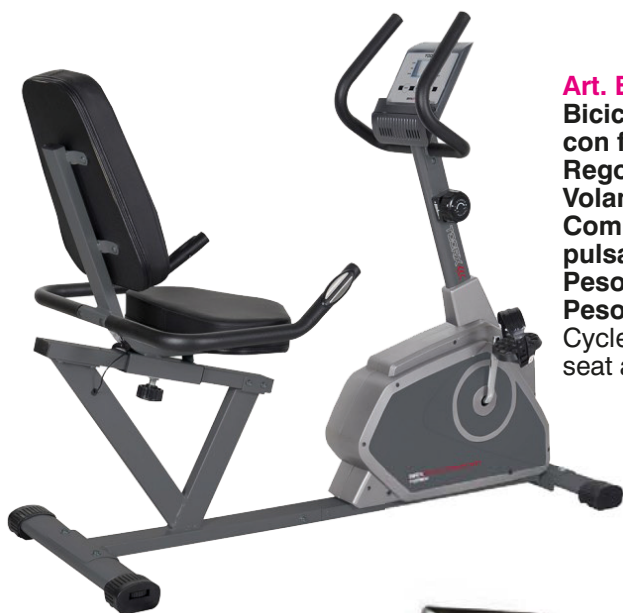

**Art. BRX-RC**

Bicicletta da camera BRX-R 65 COMFORT con freno magnetico e sedile con schienale  
Regolazione dell'intensità manuale a 8 livelli  
Volano da 7 Kg.  
Computer a 7 funzioni: tempo, velocità, distanza, calorie, pulsazioni con sensori Hand Pulse, odometro, scan  
Peso massimo utilizzatore 110 Kg.  
Peso dell'attrezzo 29,5 Kg.  
Cyclette Magnetic with 7 function computer, seat adjusting system



**Art. 18220**  
Coprisedella spinning  
Seat cover  
for spinning bike



**Art. SRX60**

Spinning Bike  
SRX60 EVO  
con volano da 20 Kg.  
Trasmissione a cinghia con pignone fisso  
Sistema di frenaggio a tampone con feltri  
Computer con LCD (velocità, tempo, distanza, calorie, odometro, pulsazioni)  
Sella regolabile in orizzontale ed in altezza  
Manubrio regolabile in altezza con appoggio per l'avambraccio  
Portaborraccia  
Peso massimo utilizzatore 125 Kg.  
Peso dell'attrezzo 41 Kg.  
Cyclette Magnetic with seat and handle-bar adjusting systems



**Senza motore.  
Adatto per camminare,  
non per correre**  
With no engine. Suitable for  
walking, not to run

pg.13

**Art. TFK-MAG**

**TAPIS ROULANT MAGNETICO TFK-SLIM-MAG**

piano di corsa cm.38x102

sistema di frenaggio magnetico su 8 livelli

doppio volano Kg.6 - peso massimo

utilizzatore Kg.100 - display LCD indicante velocità,

frequenza cardiaca, distanza, tempo,

consumo calorico, scan, rilevazione cardio Hand Pulse

Tapis roulant magnetic with no engine,

with multi function computer



**Art. TFK-200**

**TAPIS ROULANT TFK-200**

motore 1,75/2,75 HP DC - velocità 0,8-14 Km/h

inclinazione manuale - piano di corsa cm. 42x123

peso massimo utilizzatore 100 Kg.

1 programma libero, 16 preimpostati, display LCD

indicante velocità, frequenza cardiaca, distanza,

tempo, consumo calorico, programma in esecuzione

Tapis roulant with 1,75/2,75 hp engine and

multi program computer

pg.13

**ATTENZIONE:** questi prodotti sono  
concepiti esclusivamente per uso  
home fitness, perciò la garanzia  
non copre il loro utilizzo presso  
palestre o centri sportivi



**Art. TFK-455**

**TAPIS ROULANT TFK-455 SLIM - salvaspazio**

motore 2,00/3,00 HP DC - velocità 0,8-16 Km/h

inclinazione elettrica - piano di corsa cm.42,5x127

peso massimo utilizzatore 110 Kg.

1 programma libero, 12 preimpostati, display LCD

indicante velocità, inclinazione, frequenza cardiaca

tramite Hand Pulse, distanza, tempo,

consumo calorico, programma in esecuzione

Tapis roulant with 2/3 hp engine and multi program computer

**Art. TRXRC**  
**Vogatore Rower Compact - display LCD indicante  
numero vogate, calorie, tempo, scan  
regolazione sforzo su 12 livelli  
peso max utilizzatore 110 Kg.  
Rower machine with computer**



## CASACCHE - Mesh Shirts



**Art. 088-A**

### Casacca traforata fluo taglia adulto

Fluo pierced training bib adult size - colors as in the picture



**Art. 088-B**

### Casacca traforata fluo per bambini fino a 9 anni

Fluo pierced training bib small size  
(for children up to 9 years)  
colors as in the picture



pg.15

**Art. 088-D**

### Casacca traforata double-face fluo taglia adulto colori rosso/blu - giallo/arancio

Fluo pierced training bib double-face adult size  
colors red/blue - yellow/orange



**Art. GIL01**

### Gilet steward

Colori giallo - arancio  
Colors yellow - orange



## PANTALONCINI - CALZE - GUANTI - T-SHIRT - GIACCHE PIOGGIA Shorts - Socks - Gloves - T-shirt - Rain jackets

**\*\* QUANTITÀ PER TAGLIA E COLORE MULTIPLA DI 5 PEZZI \*\***

Quantity by size and color multiple of 5 pieces



### Art. MF01

Pantaloncino da allenamento  
100% poliestere  
taglie dalla 3XS alla XXL  
Colori: royal, bianco, bordeaux,  
verde, navy, rosso, nero  
(quantità per taglia e colore  
multipla di 5 pz.)  
Shorts in polyester  
size from 3XS to XXL  
Colors: white, red, royal,  
blue, black, brown, green  
(quantity by size and color  
multiple of 5 pieces)

pg.15



**Offerta sul  
listino!**  
Check on  
price list!

### Art. IS005

Paio calze calcio con piede  
Taglie  
Bimbo: 29-34  
Ragazzo: 35-40  
Uomo: 41-46  
Colori: royal, giallo limone, bianco,  
bordeaux, navy, rosso, nero,  
Pair of soccer socks sizes: Kid, JR, SR  
Colors: white, red, royal, blue, black, brown,  
lemon yellow



### Art. IGUAS

Paio Guanti in acrilico  
colore nero  
misura junior e senior  
con antiscivolo  
Black acrylic Gloves  
size junior and senior  
anti-skid



pg.16

### Art. E6000

Scaldacollo in pile  
taglia unica regolabile  
colore navy o nero  
Neck warmer in pile  
one size fits all

Art. E6013  
Berretto in acrilico  
nero, navy  
taglia senior  
Winter Cap  
size senior



pg.15



Art. 07761A  
Giacca antipioggia con marsupio  
taglie dalla XXXS alla XXL  
colore navy  
Rain Jacket - sizes XXXS to XXL  
color blue



pg.15

pg.16

### Art. TSG10/TSG11

T-SHIRT colori: bianco, nero, rosso,  
verde, giallo, arancio, blu, royal  
misure: bambino dalla S alla XL adulto dalla S alla XXL,  
neutra oppure personalizzata con logo ad un colore  
(ordine minimo per la personalizzazione 50 pezzi)  
T-Shirt various colors and size, also with your logo on request  
(minimum order for customization 50 pieces)

● I numeri in giallo indicano la pagina di riferimento del Listino Prezzi 2021-2022

**Art. SB099**

**TUBOLARE BARRET in microfibra 108 dinari**  
Prodotto tecnico brevettato come modello d'uso CEE - Made in Italy  
Lascia traspirare la pelle e ripara dal freddo e dal vento  
utilissimo in molteplici situazioni:  
durante e dopo gli allenamenti, durante gli incontri,  
per sostenere la tua squadra, nel tempo libero, in moto etc.

Barret TUBOLAR HAT in microfiber - made in Italy patented  
BTH lets your skin breath while protecting you from cold and wind  
you can wear it during or after training, during the game, in your spare time,  
to support your team, when riding your bike etc.

utilizzabile come scaldacollo, foulard, bandana, fascia, passamontagna etc.



Prodotto  
bi-elastico  
senza cuciture  
bi-elastic  
seamless

pg.16



it can change shape from neck warmer to head band to foulard to bandana



**A differenza del comune  
prodotto in pile, la  
microfibra del Tubolare  
Barret impedisce il  
surriscaldamento e  
l'eccessiva sudorazione  
della pelle, grazie  
alla sua speciale  
traspirazione e  
leggerezza**



**PRODOTTO  
TECNICO  
TECHNICAL  
PRODUCT**

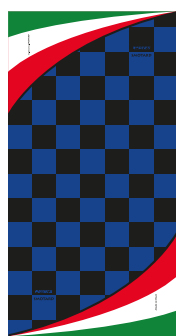
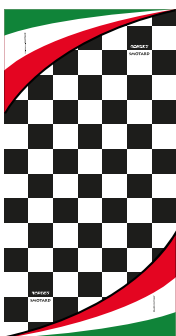

**Colori disponibili:**  
bianco/nero, nero/azzurro,  
rosso/nero, bianco/celeste,  
bianco/rosso, giallo/rosso,  
azzurro nazionale italiana  
(prodotto personalizzabile su  
richiesta per ordine minimo di  
100 pezzi, con spese  
per elaborazione grafica da  
definire)

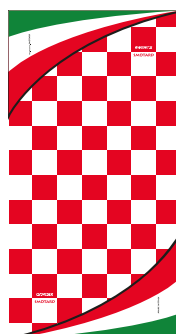
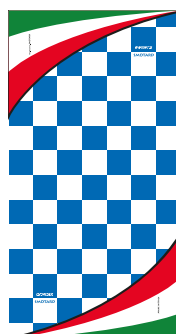
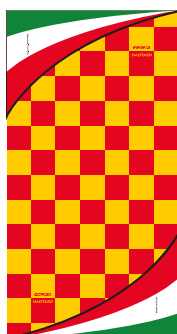

Colors available  
as in the pictures  
Barret tubolar HAT can be  
personalized with your logo and  
colors with a minimum order of  
100 pieces (graphic work not in-  
cluded in the price)

● Numbers in yellow show the relevant page on 2021-2022 Price List

## TACCHETTI ED ACCESSORI PER SCARPE - Studs and Shoe accessories



**Art. 265bis / 268bis / 270bis**  
**Tacchetto alluminio conico**  
**mm. 14-17-19**  
conf. 100 pz. per misura  
Conical aluminium Stud  
14-17-19 mm.  
100 piece pack



**Art. BACS**  
**Blister 12 tacchetti in alluminio**  
**conici senza rondelle**  
**(8 x mm. 14 + 4 x mm. 17)**  
12 piece pack conical aluminium  
studs without washers



**Art. BACSC**  
**Blister 12 tacchetti in alluminio**  
**conici con rondelle**  
**(8 x mm. 14 + 4 x mm. 17)**  
12 piece pack conical aluminium  
studs with washers

pg.13

pg.14



**Art. 262/263/264/265/266/267/268/269/270**  
**Tacchetto alluminio conico tornito**  
**mm. 11-12-13-14-15-16-17-18-19**  
conf. 100 pz. per misura  
Milled conical aluminium Stud  
100 piece pack



**Art. PR11 / PR13 / PR14 / PR17**  
**Tacchetto alluminio conico tornito**  
**punta rinforzata mm. 11-13**  
**14 (ad esaurimento) -17**  
conf. 100 pz. per misura  
Conical aluminium Stud  
reinforced tip 11-13 (14 until available) -17 mm.  
100 piece pack



**Art. A11 / A13 / A15 / A17**  
**Tacchetto alluminio conico tornito**  
**Argentinos superleggero Serie A**  
**mm. 11-13-15-17**  
Milled conical aluminium Stud  
ultra-light Serie A  
11-13-15-17 mm.



**Art. AL09F / AL11F / AL13F / AL15F**  
**Tacchetto alluminio conico tornito Argentinos superleggero Serie A**  
**con filettatura maggiorata (Adidas) mm. 9-11-13-15**  
Milled conical aluminium Stud ultra-light Serie A  
with increased thread (Adidas) 9-11-13-15 mm.



**Art. 292 / 293 / 294 / 294bis**  
**Tacchetto in nylon conico punta rinforzata in alluminio**  
 mm. 11, 13, 15, 17 - conf. 100 pz. per misura  
 Conical Nylon stud with reinforced tip - 100 piece pack



**Art. BNPR1 / BNPR2**  
**Blister 12 tacchetti in nylon punta rinforzata**  
 mm. 11-13-15 / mm. 13-15-17  
 12 piece pack nylon studs with reinforced tip  
 mm. 11-13-15 / mm. 13-15-17



**Art. M204 / M205**  
**Tacchetto in nylon monocolore**  
 mm. 13 / 16  
 conf. 100 pz. per misura  
 Nylon Stud  
 mm. 13 / 16 - 100 piece pack

pg.14



**Art. M203**  
**Blister 12 tacchetti in nylon monocolore**  
 8 x mm. 13 + 4 x mm. 16  
 (nero, rosso, bianco)  
 12 piece pack nylon studs single color (black, red, white)



**Art. 35M12**  
**Tacchetto gomma base stretta mm. 12 conf. 100 pz.**  
 Narrow Base Rubber Stud mm. 12 - 100 piece pack  
**Art. 35M14**  
**Tacchetto gomma base stretta mm. 14 conf. 100 pz.**  
 Narrow Base Rubber Stud mm. 14 - 100 piece pack



**Art. 072.11.13**  
**Confezione blister 12 Tacchetti gomma base larga per terreni gelati**  
 (8 x mm. 11+ 4 x mm. 13)  
 Wide Base Rubber Stud - for icy ground  
 12 piece pack



**Art. 302 Base filettata in alluminio - conf. 50 pz. per misura**  
 Threaded aluminium bases mm. 7, 8, 10, 12 - 50 piece pack  
**Art. 302G Base filettata in alluminio - conf. 50 pz. per misura**  
 Threaded aluminium bases mm. 13, 14, 17 - 50 piece pack  
**Art. 314 Rondella in alluminio - conf. 100 pz.**  
 Aluminium washer - 100 piece pack



**Art. CHAZ**  
**Chiave in acciaio zincocromata**  
 Stud Key





**Art. 317 / 318**  
**Paio tendiscarpe a molla,**  
**misura 40-42 / 43-45**  
 Shoe stretchers with spring,  
 size 40-42 / 43-45

● pg.14

**Art. BLS4**  
**Lastrina antitrauma ritagliabile in gel forata**  
**spessore mm.4 dimensioni cm.14x28**  
**da utilizzare a contatto con la pelle del piede**  
**dentro la scarpa in caso di ferite, vesciche o**  
**contusioni: attutisce il dolore derivante dalla**  
**corsa e dall'impatto con la palla**

● pg.15

Anti-shock pierced gel thickness 4 mm. size  
 cm.14x28 you can cut it and place it inside your  
 shoe against the skin to prevent pain from running  
 and kicking in case of small foot injuries

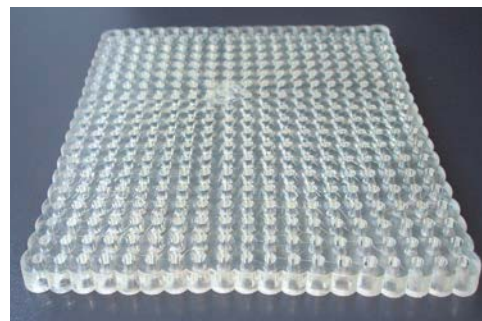

**Art. 326 / 326FL / 327 / 327FL / 328 / 328FL**  
**Paio lacci per scarpe cm.120-150-180**  
**colori nero, bianco, giallo fluo, verde fluo, arancio fluo**  
 Pair of shoe laces 120-150-180 cm. long  
 colors: black, white, fluo yellow, fluo green, fluo orange



**Art. SOLSP**  
**Paio solette in gel**  
**profumate ritagliabili**  
 Gel Insoles



**Art. ALZ.SP**  
**Paio Alzatacco in gel**  
**taglia 1 donna**  
**taglia 2 uomo**  
 Gel under heel softeners  
 woman and man sizes



**Art. 21654**  
**Paio solette**  
**Spugna Sport**  
 Sport Insoles

● pg.15



**Art. E6694**  
**Paio Alzatacco in silicone**  
**misura S (33/36) - M (37/40)**  
**L (40/44) - XL (44/48)**  
 Silicone under heel softeners  
 various sizes



**Art. 238.1**  
Grasso Aquila Kg.1  
Aquila Grease for shoes  
Kg. 1

pg.14

**Art. 238**  
Grasso Aquila ml. 100  
Aquila Grease for shoes  
ml. 100

**Art. 34071A**  
Spray  
impermeabilizzante  
Spray waterproofing



pg.14

**Art. D122X**  
Spray Dilato ml. 200  
ammorbidente  
Spray to soften leather  
soccer shoes



**Art. S489**  
Spazzola in setola naturale  
Shoe Brush

pg.14



**Art. SL.S**  
Spugna lucidascarpe  
(ad esaurimento)  
Shoe polisher sponge  
(until available)



**Art. TE.540.01**  
Zerbino pulisciscarpe  
in plastica con ventose  
dimensioni cm.35x27  
Shoe cleaning device  
in plastic with suckers  
dimension 35x27 cm.

pg.15

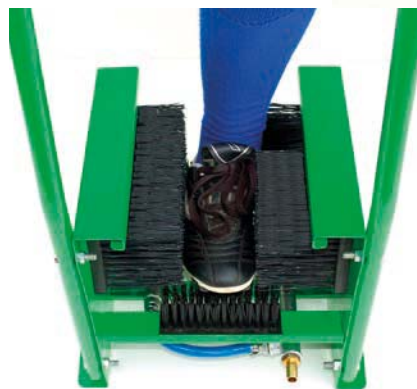

**Art. FA270**  
Macchina lavascarpe con 4 spazzole sostituibili  
getti incrociati regolabili ad alta pressione  
completo di poggiamani e 4 fori di fissaggio a terra  
in dotazione fascetta in acciaio per collegamento tubo  
mm 15x21 (non incluso) alla rete idrica.  
Shoe washing device - high pressure crossed water jets  
iron frame with handles - replaceable brushes  
easy fixing to the floor with 4 holes



## PARASTINCHI - Shinguards



**Art. PSCV**  
Paio parastinchi  
senza cavigliera  
misura adulto e bambino  
Pair of shinguards  
without ankle protection  
junior and senior size

pg.15



**Art. IS30HS**  
Paio parastinchi  
senza cavigliera  
misura S-M-L  
Pair of shinguards  
without ankle  
protection  
size S-M-L

**INNOVATIVO PARASTINCO BARRET REALIZZATO CON SPECIALI LISTELLI ANATOMICI  
LEGERISSIMO MA CON ALTA RESISTENZA ALL'IMPATTO**  
BARRET SPECIAL SHINGUARDS anatomic, very light and highly resistant to impact



**Art. BP90**

**Paio parastinchi Barret senza cavigliera misura unica**  
Pair of Barret shinguards without ankle protection  
one size fits all



**BREVETTATO  
PATENTED**



**Art. PBC**  
Paio parastinchi  
con cavigliera  
misura adulto  
Pair of shinguards  
with ankle protection  
senior size



## FASCE CAPITANO - GUANTI PORTIERE - Captain's Armbands - GK Gloves

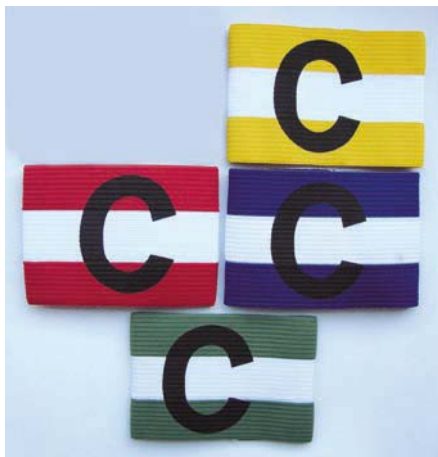

**Art. 150**  
Fascia capitano elastica  
misura adulto  
Elastic Captain's armband  
size adult

**Art. 150.B**  
Fascia capitano elastica  
misura bambino  
Elastic Captain's armband  
size children

pg.16



**Art. 150F** Fascia capitano elastica  
mis. adulto colore giallo o arancio fluo  
Elastic Captain's armband adult size  
colors: fluorescent yellow and orange



**Art. 150V.9**  
Fascia capitano con velcro, taglia adulto  
colori: bianco, rosso, giallo fluo, verde,  
blu e arancio fluo - h. cm. 9  
Captain's armband adjustable length - 9 cm. height  
size adult - colors: white, red, fluo yellow,  
blue, green, fluo orange



**Art. 150V / 150V.B**  
Fascia capitano con velcro, taglia adulto o bambino  
Modello Champions colori bianco, rosso, giallo, verde,  
blu, fucsia, arancio - h. cm. 6,5  
Captain's armband adjustable length - 6,5 cm. height  
size adult or children  
colors: white, red, yellow, blue, green,  
fuchsia, orange



**Art. 150V.9N**  
Fascia capitano neutra con velcro, taglia adulto  
h. cm. 9 - colori: giallo fluo, arancio,  
bianco, rosso, verde, blu  
Captain's armband with no "C" printed  
adjustable length 9 cm. height size adult  
colors: fluo yellow, orange, white, red, green,  
blue



**Art. 1000PG**  
Paio Guanti portiere misure da 6 a 11  
Pair of Goalkeeper Gloves  
Size from 6 to 11



pg.15

**Art. F30BG**  
Paio Guanti  
portiere junior  
misure da 4 a 7  
Pair of  
Goalkeeper Gloves  
Size from 4 to 7



I colori dei guanti raffigurati nelle immagini possono variare

## NUMERAZIONI TERMOSALDABILI

### Numbers for Uniforms

**Colori disponibili: bianco, giallo, rosso, verde, royal, blu, granata, nero, oro, argento**  
 Available colors: white, yellow, red, green, royal, blue, brown, black, gold, silver

Art. PN23



Art. PN18



Art. PN10



● pg.16

Art. PG23

**Numeri termosaldabili Serie Omega h.23 cm. in confezione da 1 a 22**  
 Numbers for sport uniforms Omega series 23 cm. height package from number 1 to number 22

Art. PG18

**Numeri termosaldabili Serie Omega h.18 cm. in confezione da 1 a 22**  
 Numbers for sport uniforms Omega series 18 cm. height package from number 1 to number 22

Art. PG10

**Numeri termosaldabili Serie Omega h.10 cm. in confezione da 1 a 22**  
 Numbers for sport uniforms Omega series 10 cm. height package from number 1 to number 22

Art. PN23

**Numeri termosaldabili Serie Omega h.23 cm. numeri singoli (da 0 a 9)**  
 Single numbers for sport uniforms Omega series 23 cm. height (from 0 to 9)

Art. PN18

**Numeri termosaldabili Serie Omega h.18 cm. numeri singoli (da 0 a 9)**  
 Single numbers for sport uniforms Omega series 18 cm. height (from 0 to 9)

Art. PN10

**Numeri termosaldabili Serie Omega h.10 cm. numeri singoli (da 0 a 9)**  
 Single numbers for sport uniforms Omega series 10 cm. height (from 0 to 9)



**TEMPERATURA MASSIMA 135 °C**  
**TEMPO MASSIMO DI APPLICAZIONE**  
**6 SECONDI**  
**MAXIMUM TEMPERATURE 135 °C**  
**MAXIMUM 6 SECOND PRINT**

Art. PG4

**Numeri termosaldabili Serie Omega h.4 cm. in confezione blister numeri da 1 a 100 colore bianco, blu o nero**  
**La numerazione progressiva (di 100 in 100) arriva fino a 500**  
 Numbers for sport uniforms Omega series 4 cm. height package from number 1 to number 100 black, blue or white color

## MATERASSINI - Mats

**Art. 044**  
**Materassino pieghevole**  
**alta densità**  
**cm. 180x50x0,7**  
Folding foam Mat  
high density  
180x50x0,7 cm.

**Art. 044-A**  
**Materassino pieghevole**  
**alta densità**  
**cm. 180x60x0,7**  
Folding foam Mat  
high density  
180x60x0,7 cm.

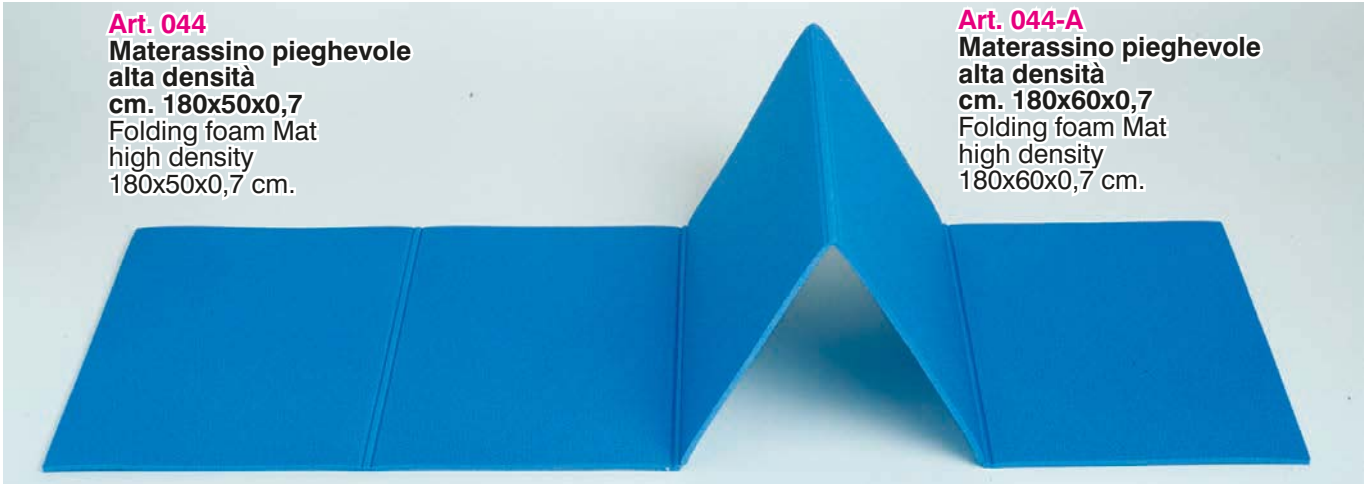

pg.16

**Art. 044-R**  
**Materassino arrotolabile**  
**alta densità**  
**cm. 180x50x0,6**  
Rolled foam Mat  
high density 180x50x0,6 cm.

**Art. AS803**  
**Materassino Exercise Mat**  
**imbottito e serigrafato cm.180x60x2,5**  
PVC Mat 180x60x2,5 cm.



**Art. 30924**  
**Materassino Yoga arrotolabile**  
**cm. 172x60x0,4**  
Rolled Yoga Mat 172x60x0,4 cm.

## LAVAGNE TATTICHE PER CALCIO E CALCETTO - Tactical Boards for Football and Futsal

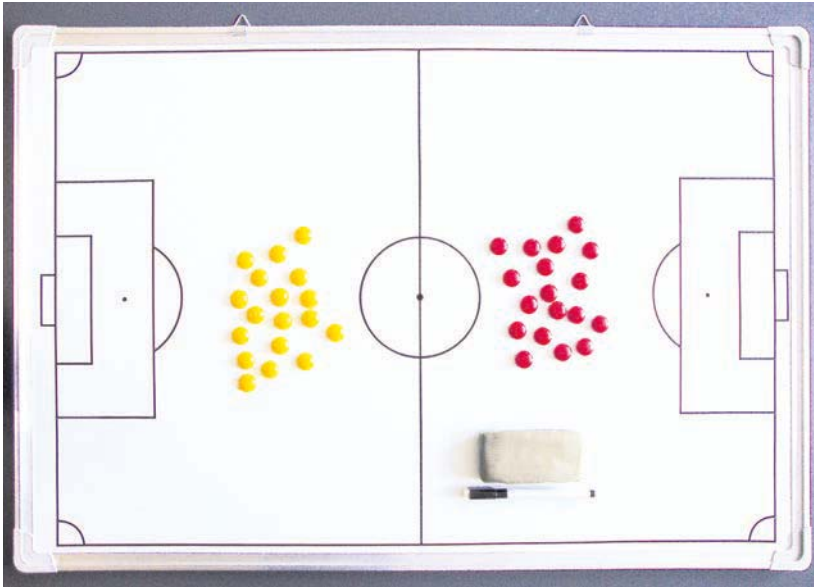

**Art. 087**  
**Lavagna magnetica cm. 60x90 cancellabile con cornice metallica**  
 Tactical board 60x90 cm. magnetic and erasable with metal frame

**Art. 087.BO**  
**Borsa per lavagna magnetica Art. 087 cm. 60x90**  
 Bag for tactical board Art. 087 60x90 cm.



**Art. PM60**  
**Serie pedine magnetiche di ricambio per lavagna Art. 087**  
 Spare magnetic pieces for tactical board Art. 087

pg.17

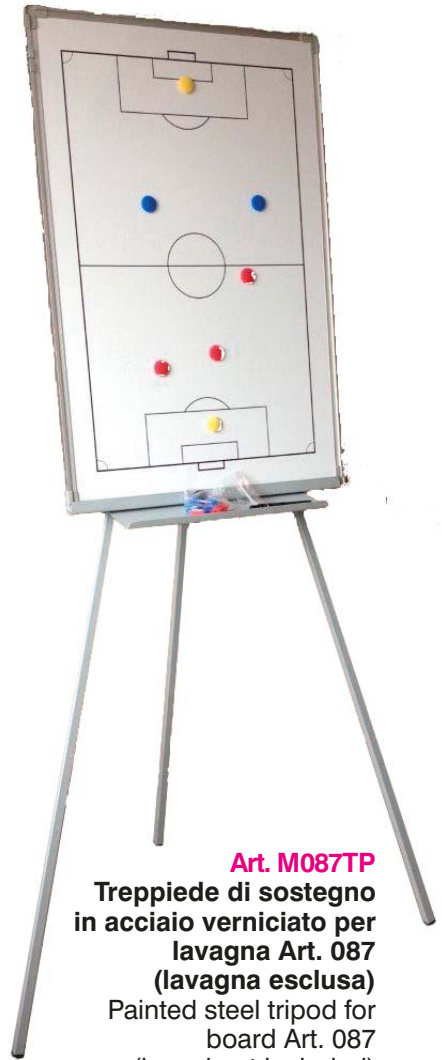

**Art. M087TP**  
**Treppiede di sostegno in acciaio verniciato per lavagna Art. 087 (lavagna esclusa)**  
 Painted steel tripod for board Art. 087 (board not included)



**Art. 090**  
**Lavagna su treppiede con 100 fogli cm.70x100 (non cancellabili)**  
 Board on tripod with 100 sheets 70x100 cm. (not erasable)

**Art. 090RIC**  
**Ricambio 100 fogli cm.70x100 per lavagna Art. 090 (treppiede escluso)**  
 100 spare sheets for board Art. 090 (tripod not included)

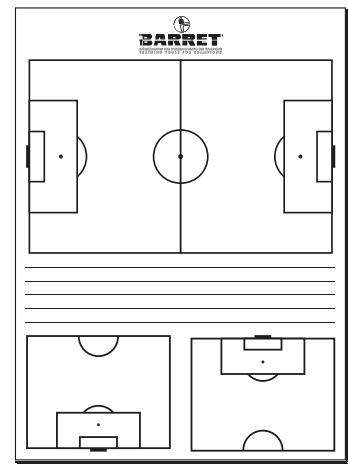

**Art. BL50F**  
**Blocco con 50 fogli formato A4 (non cancellabili)**  
 Block with 50 A4 sheets (not erasable)



**Art. 05030425**

**Set 25 fogli adesivi cm.60x80 applicabili a porte e pareti, rimuovibili e cancellabili (ideale per partite in trasferta)**  
 Set of 25 adhesive sheets 60x80 cm. on a roll, easily separable. Due to the electrostatic charge, it can be hung on any door or wall and removed several times without leaving any trace. Ideal for away games. Either permanent or non permanent markers work for writing

● pg.17

**Lato A**  
Side A

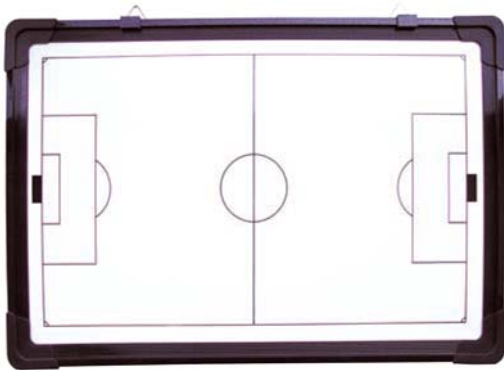

**Lato B**  
Side B

**Art. 089**

**Lavagna magnetica bifacciale cancellabile con borsa cm. 45x30**  
 2 face Tactical Board magnetic and erasable 45x30 cm. with bag

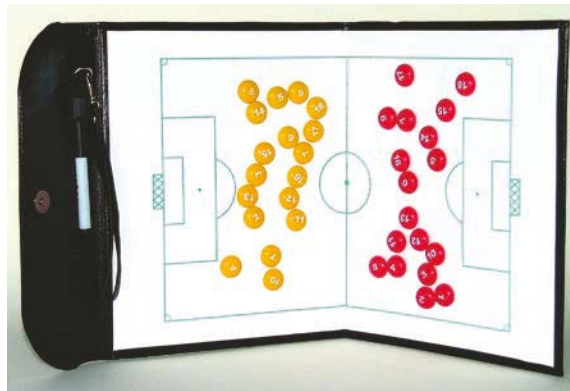

**Art. 089-P**

**Lavagna magnetica cancellabile pieghevole cm. 46x25**  
 Foldable Tactical Board magnetic and erasable 46x25 cm.

**Lato A**  
Side A

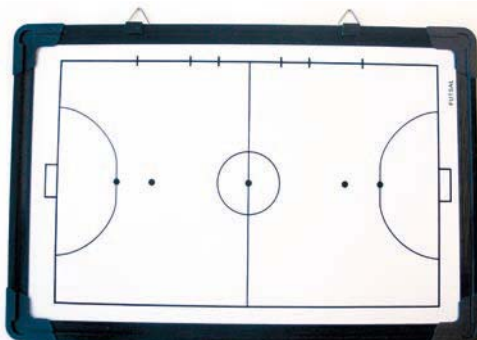

**Lato B**  
Side B

**Art. 089CM**

**Lavagna Tattica Calcio bifacciale magnetica e cancellabile cm. 45x30**  
 2 face Futsal Tactical Board magnetic and erasable 45x30 cm.

● pg.18



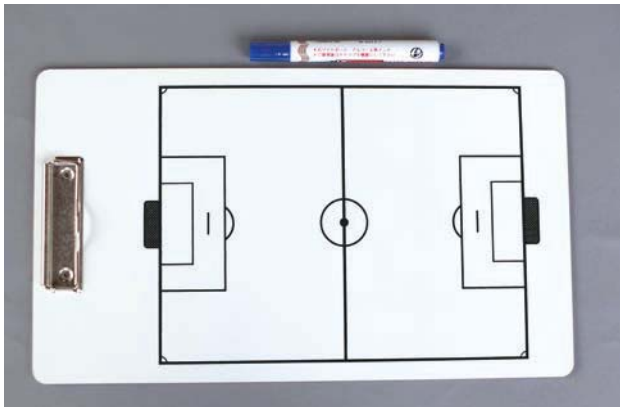

**Art. 089-A**  
**Lavagna bifacciale cancellabile cm. 40x23**  
 2 face Tactical Board erasable, 40x23 cm.



**Art. CSRK**  
**Lavagna Tattica magnetica cancellabile**  
**con block-notes cm. 40x23**  
 Magnetic Tactical Board 40x23 cm. erasable

● pg.17

● pg.18

**Art. 089-C**  
**Lavagna Tattica**  
**Calcetto bifacciale**  
**cancellabile**  
**cm. 40x23**  
 2 face Futsal  
 Tactical Board 40x23  
 cm. erasable

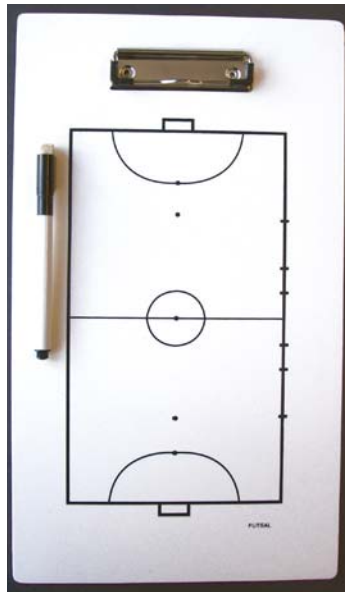

**Art. PM**  
**Serie pedine magnetiche**  
**di ricambio per lavagne**  
**di dimensioni ridotte**  
 Spare magnetic pieces  
 for small tactical boards

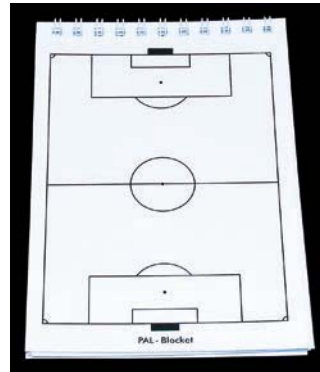

**Art. PAL-B**  
**Pal Block - blocco**  
**tascabile con 25 pagine**  
**copertina cancellabile**  
 Pocket block-notes  
 25 pages with erasable cover

● pg.18



**Art. 18330**  
**Lavagna magnetica cancellabile pieghevole**  
**Multisport (Calcio, Basket, Volley, Rugby,**  
**Badminton, Tennis, Floorball, Pallamano,**  
**Hockey su ghiaccio)**  
**dimensioni cm. 32x22**  
 Multisport Foldable Tactical Board magnetic and  
 erasable 32x22 cm.

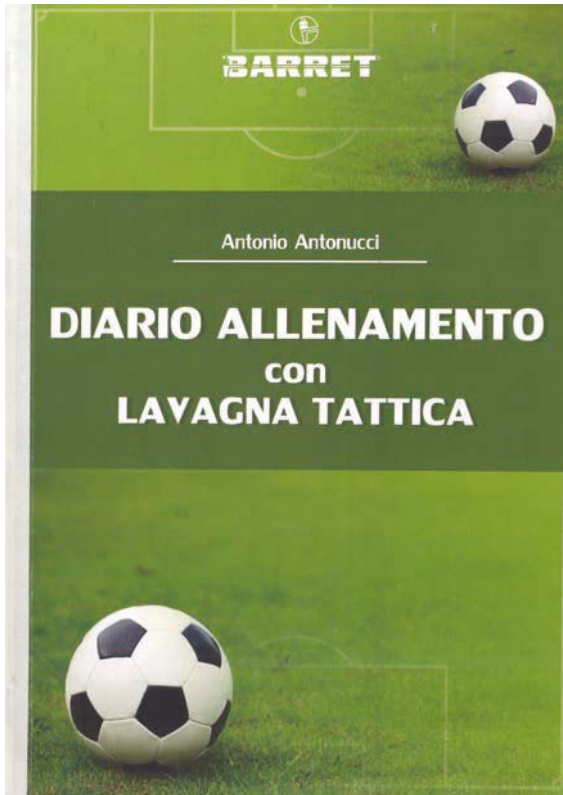

**Art. DALT**

**DIARIO ALLENAMENTO**

**per l'allenatore di calcio con lavagna tattica**

Lo strumento ideale per programmare e registrare durante il corso della stagione tutto ciò che riguarda la preparazione fisica generale, specifica e speciale, i test di valutazione, la preparazione psico-tattica teorica e pratica, la preparazione psico-cinetica, gli esercizi tecnico-tattici, il riscaldamento, il defaticamento e la preparazione post-infortunio della Vostra squadra di calcio e dei singoli giocatori che la compongono. E' inoltre fondamentale per l'annotazione di tutto ciò che riguarda le partite amichevoli e le partite di campionato, in relazione agli avversari da incontrare.

Il diario è corredato di una retrocopertina pieghevole utilizzabile come lavagna tattica cancellabile a 3 facce

140 pagine



● pg.18

Con lavagna cancellabile sulla retrocopertina



**GHIACCIO - TAPE - CREME - OLI**  
Ice - Tape - Creams - Oils

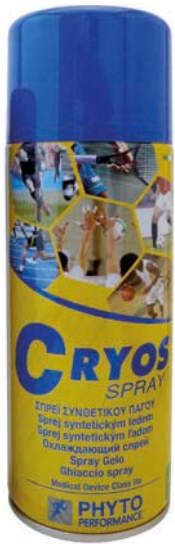

**Art. 164**  
**Ghiaccio spray**  
ml. 400  
Ice spray 400 ml.



**Art. 165**  
**Ghiaccio**  
**in busta monouso**  
Ice in envelope



**Art. NE2.5**  
**Nastro economico cm. 2,5x13,7 mt**  
Tape cm. 2.5x13,7 mt.

**Art. NE5**  
**Nastro economico cm. 5x13,7 mt**  
Tape cm. 5x13,7 mt.

**Art. N2.5**  
**Nastro tipo Strappal cm. 2,5x10 mt**  
Tape Strappal cm. 2,5x10 mt.

**Art. N5**  
**Nastro tipo Strappal cm. 5x10 mt**  
Tape Strappal cm. 5x10 mt.



**Art. 9254**  
**Salvapelle**  
Skin Protection

pg.17



**Art. IDNC38**  
**Nastro adesivo colorato fermacalze**  
cm. 3,8x13,7 mt.  
colori: rosso, nero, blu, verde e giallo  
Coloured Tape stop stockings  
in red, black, blue, green and yellow



**Art. TPG09**  
**Fraplast cm. 8 (Tensoplast)**



**Art. IPT01**  
**Cutter taglia bendaggi**  
Cutter for bandages

**Art. IPT02**  
**Forbice**  
**taglia taping**  
in acciaio inox  
Scissors for taping



**Art. T255**  
**Kinesio Tape**



**Art. ONC**  
**Olio riscaldante 500 ml**  
 stimola la circolazione,  
 tonifica la muscolatura,  
 previene le lesioni muscolari  
 microtraumatiche  
 Oil 500 ml  
 for muscle warm up, stimulating  
 blood circulation  
 and preventing micro injuries



**Art. CNC**  
**Crema riscaldante 250 ml**  
 stimola la circolazione,  
 tonifica la muscolatura,  
 previene le lesioni muscolari  
 microtraumatiche  
 Cream 250 ml  
 for muscle warm up, stimulating  
 blood circulation and preventing  
 micro injuries



**Art. IRVF**  
**Vaselina filante**  
 per curare le zone della pelle a  
 maggiore sollecitazione  
 Vaseline avoiding skin problems



**Art. IRFA**  
**Fango argilla per impacchi**  
 dopo distorsioni,  
 per assorbimento ematomi  
 Special mud to be used after  
 injuries (i.e. sprained ankles)  
 and to absorb bruises

pg.17



**Art. IJGE**  
**Crema Gel Jestic**  
 coadiuvante per  
 infiammazioni, contusioni  
 e lesioni dell'apparato  
 muscolare  
 Cream Gel Jestic  
 for treating minor injuries  
 and sore muscles



**T10R**  
**Gel**  
 freddo  
 refrigerante  
 immediato su  
 contusioni o  
 strappi muscolari  
 Cold Gel for  
 immediate  
 application on  
 bruises and sore  
 muscles

**T17G**  
**Cuscinetto**  
 in gel  
 dim. cm.17x27  
 (effetto freddo  
 ed effetto caldo)  
 Gel Pillow  
 17x27 cm.  
 (both for cold  
 and hot therapy)

T17G

## BORRACCE - Water Bottles

pg.16

pg.17



**Art. K8**  
**Borraccia da 1 litro**  
**in plastica**  
1 liter plastic Water Bottle

Certificate  
per uso  
alimentare  
Food grade  
certified



**Art. B500ML**  
**Borraccia**  
**da ½ litro**  
**in plastica**  
½ liter plastic  
Water Bottle



**Art. BAL1**  
**Borraccia da 1 litro**  
**in alluminio**  
1 liter aluminium Water Bottle



**Art. BAL05**  
**Borraccia da ½ litro**  
**in alluminio**  
½ liter aluminium Water Bottle



**Art. BTA05**  
**Borraccia termica**  
**da ½ litro in acciaio**  
**mantiene costante la temperatura**  
**del liquido (sia caldo che freddo)**  
½ liter thermic steel Water Bottle  
keeps the liquid temperature  
unchanged

Certificate  
per uso  
alimentare  
Food grade  
certified



**Art. IRTT**  
**Distributore termico 6 litri**  
**con rubinetto**  
Thermos 6 liter with tap



pg.16

pg.17

**Art. 308.C**  
**Cestello per 6 Borracce**  
**in plastica**  
Holder for 6 plastic  
water bottles



**Art. 306**  
**Kit 6 Borracce**  
**da 1 litro in plastica con cestello**  
Kit 6 one liter plastic water bottles  
with holder



**Art. C6B**  
**Cestello per 6 Borracce**  
**in plastica pieghevole**  
Foldable Holder for 6  
plastic water bottles



**Art. KIT6**  
**Kit 6 Borracce da 1 litro**  
**in plastica con cestello pieghevole**  
Kit 6 one liter plastic water bottles  
with foldable holder



**Art. OC8**  
**Cestello per 8 Borracce**  
**in plastica pieghevole**  
Foldable Holder for 8  
plastic water bottles



**Art. K8S6**  
**Kit 8 Borracce**  
**da 1 litro in plastica**  
**con cestello pieghevole**  
Kit 8 one liter plastic water bottles  
with foldable holder

## BANDIERINE - Flags



**Art. 074**  
**Kit completo**  
**4 paletti**  
**calcio d'angolo**  
**con snodo**  
**in PVC Ø mm.32**  
**(bandierine colore**  
**giallo o rosso)**  
**Kit 4 complete**  
**flexible Corner Poles**  
**in PVC Ø 32 mm.**  
**(yellow or red flags)**



**Art. 074RP**  
**Kit completo**  
**4 paletti**  
**calcio d'angolo**  
**con snodo**  
**rinforzati con tubo**  
**in polipropilene**  
**Ø mm.40**  
**(bandierine colore**  
**giallo o rosso)**  
**Kit 4 complete**  
**flexible Corner**  
**Poles reinforced**  
**with polypropylene**  
**pipe Ø 40 mm.**  
**(yellow or red flags)**

pg.18



**Non utilizzabili**  
**per partite ufficiali**  
**Not for official**  
**matches**

**Art. 073**  
**Kit completo**  
**4 paletti calcio d'angolo**  
**in PVC Ø mm.32**  
**(bandierine colore giallo o rosso)**  
**Kit 4 complete Corner Poles**  
**in PVC Ø 32 mm.**  
**(yellow or red flags)**



**Art. 368**

**Art. 368 Set ricambi**  
**4 Bandierine calcio d'angolo**  
**colore giallo o rosso**  
**Set of 4 spare Corner Flags**  
**yellow or red color**



**Art. 075 / 076**  
**Coppia Bandierine segnalinee gialle o a scacchi con aste in plastica**  
Pair of linesman's Flags yellow or checked with plastic sticks

pg.18



**Art. 172**  
**Coppia Bandierine segnalinee elettroniche complete di ricevitore e borsa**  
Pair of electronic linesman's Flags complete with signal receiver and bag

pg.18



## ACCESSORI ARBITRO - Referee's accessories



**Art. 078**  
Fischio Fox 40 Classic senza pallina  
nero o colorato  
Whistle FOX 40 Classic

**078PD**  
Fischio arbitro senza pallina  
Fox 40 Classic CMG nero o  
colorato con imboccatura  
anatomica e cordino  
Whistle FOX 40 Classic CMG  
cushioned mouth grip  
(cord is included)

pg.18



**Art. 078SK**  
Fischio Fox 40 SONIK BLAST  
CMG con cordino - vari colori,  
con due camere sonore  
Whistle FOX 40 SONIK BLAST  
CMG with cord, various colors



**Art. 078CH**

Fischio senza pallina nero o colorato con cordino in confezione blister  
Plastic whistle without a ball various colors with cord

pg.18



**Art. 228C**  
Fischio in plastica  
nero con cordino  
Plastic black whistle with  
cord

**Art. 228**  
Fischio in plastica  
nero  
senza cordino  
Plastic black whistle  
without cord



**Art. 079C**  
Fischio cromato  
con cordino  
Chromed brass  
whistle with cord



**Art. FEFOX**  
Fischio elettronico  
Fox 40 con cordino  
potenza 125 dB  
Electronic Fox 40 whistle  
with cord

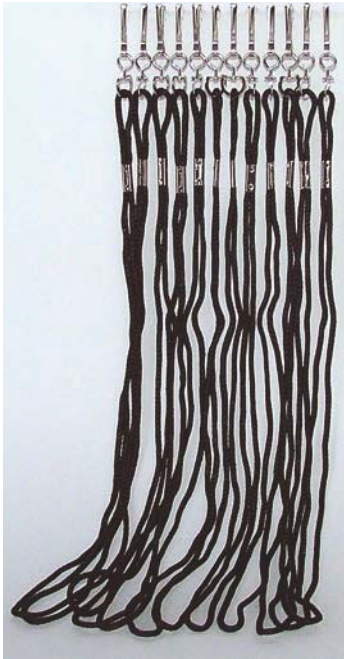

**Art. 080**  
Cordino Lanyard  
colore nero  
Nylon  
whistle cord Lanyard  
black color

pg.18



**Art. F40CAP**  
Cordino Fox antipanico  
regolabile, vari colori  
Fox whistle cord adjustable  
various colors



**Art. 9816**  
Polsino regolabile  
per fischietto Arbitro  
Adjustable wristband  
for referee's whistle



**Art. KCPFOX**  
Kit cronometro da polso e  
fischietto Fox 40 Sonik Blast  
con cordino  
Kit wrist Chronometer with Fox 40  
Sonik blast whistle with cord



**Art. RPC**  
Raccogliatore ad anelli cm.18x15  
per cartellini giocatori  
con 20 buste trasparenti  
Ring binder 18x15 cm. for players'  
cards with 20 transparent envelopes



**Art. 081F** Coppia cartellini  
giallo e rosso con custodia,  
matita e tabellino gara  
Yellow and red cards with holder,  
pen and game note card

**Art. RPCRIC**  
Ricambio 10 buste trasparenti per  
raccogliatore ad anelli Art. RPC  
Set of 10 spare envelopes for Art. RPC



**Art. ZAFN**  
Tabellino gara di ricambio  
per Art. 081F  
Spare game note card for Art. 081F



**Art. GR15**  
Coppia cartellini  
giallo e rosso  
riscrivibili con pennarello  
(cancellabili con alcol)  
Rewritable yellow  
and red cards with pen  
(erasable with alcohol)

pg.18



**Art. RYC02**  
Set 1 cartellino arbitro giallo  
e 1 cartellino arbitro rosso  
Set 1 yellow and 1 red card for referee



**Art. RCB**  
Cartellino arbitro blu  
Blue referee card

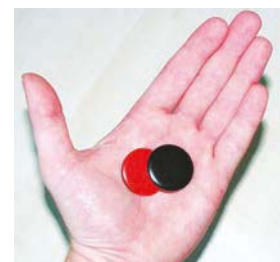

**Art. 880147**  
Moneta per arbitro  
in plastica  
rosso/nera  
Referee's coin

## SEGNALATORI MANUALI ED ELETTRONICI PER SOSTITUZIONI Manual and electronic Substitution Boards

**Art. 071**  
Serie numeri  
cambio giocatori  
(da 1 a 25)  
senza manico  
Numbers for substitution  
(from 1 to 25)  
without handle



**Art. 072**  
Serie numeri cambio  
giocatori (da 1 a 25)  
con manico  
Numbers for substitution  
(from 1 to 25)  
with handle



pg.19

**Art. E6230**  
Segnalatore bifacciale  
economico per cambio  
giocatori manuale cm.43x38  
Substitution indicator  
1 piece 2 sides

Lato A  
Side A



Lato B  
Side B



Lato B  
Side B

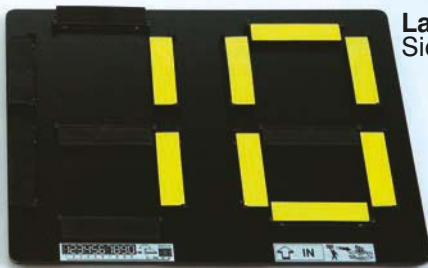
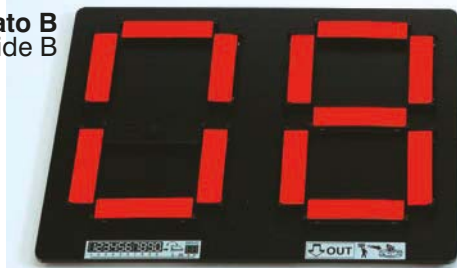

Lato A  
Side A

**Art. C00937**  
Segnalatore bifacciale per  
cambio giocatori manuale  
fluorescente - cm.40x32  
base in plastica lucida  
Substitution indicator  
fluorescent 1 piece 2 sides

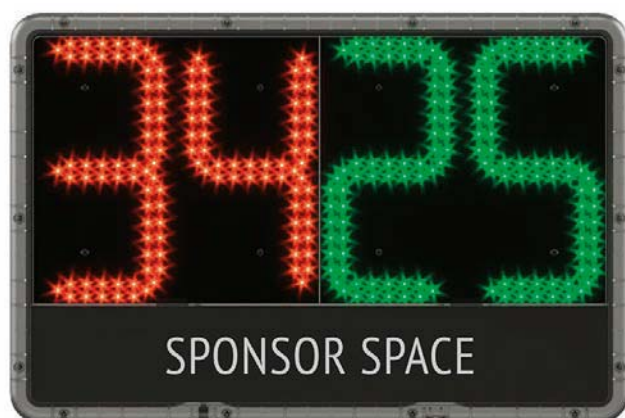

**Art. F292-30**  
Valigetta cm. 61x40x8  
per Art. FINOUT4 e FINOUT8  
Case 61x40x8 cm. for Art. FINOUT4 and FINOUT8

**Art. FINOUT4**  
Tavoletta elettronica bicolore, monofacciale  
a 4 cifre (2+2) - led verdi per giocatore entrante  
led rossi per giocatore uscente, completa di  
caricabatteria - dim. cm. 58x38x2,7 kg. 2,2  
4 Digit Electronic Substitution Board  
1 side 2 color leds (red and green) cm.58x38x2,7  
Kg. 2,2 with battery charger

**Art. FINOUT8**  
Tavoletta elettronica bicolore, bifacciale  
a 4 cifre (2+2) - led verdi per giocatore entrante  
led rossi per giocatore uscente, completa di  
caricabatteria - dim. cm. 58x38x2,7 kg. 2,25  
4 Digit Electronic Substitution Board  
2 sides 2 color leds (red and green) 58x38x2,7  
Kg. 2,25 with battery charger

**Art. 065-EC**

**Tavoletta elettronica bifacciale, bicolore DELTA 2FE1 cm.46x33x1,8 Kg.1,5 completa di valigetta e caricabatteria**  
4 digit Electronic substitution Board  
2 sides - 2 color leds (red and green)  
bag and battery charger included



**UEFA  
APPROVED**



pg.19

**Art. D2FE**

**Tavoletta elettronica bifacciale, bicolore DELTA 2FE completa di valigetta e caricabatteria cm. 64,5x39x2,5 kg. 2,8**  
UEFA Electronic substitution Board  
2 sides - 2 color leds  
bag and battery charger included



**UEFA  
APPROVED**

**UEFA  
APPROVED**

**Art. 065-F**

**Tavoletta elettronica approvata UEFA/FIFA bifacciale, bicolore a 4 cifre DELTA 2F completa di valigetta e caricabatteria led rossi e verdi - cm. 64x39x3 kg. 3**  
4 digit UEFA/FIFA Electronic substitution Board 2 sides - 2 color leds (red and green)  
bag and battery charger included



## COMPRESSORE - POMPE - MANOMETRI Inflator - Pumps - Gauges



**Art. 106**  
Compressore  
elettrico 220 Volt  
con borsa  
Electric Inflator  
220 Volt  
with bag

pg.19

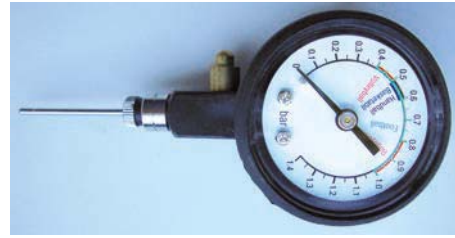

pg.18

**Art. 107**  
Manometro misura pressione palloni con valvola  
(con indicazione pressioni consigliate per vari sport)  
Pressure Gauge with valve  
(with indication of pressure for different sport balls)



**Art. US107**  
Manometro misura pressione palloni alta precisione  
con valvola (con indicazione  
pressioni consigliate per i vari sport)  
High precision pressure Gauge with valve  
(with indication of pressure for different sport balls)



**Art. 104-A** Pompa con ago - Pump with needle

pg.18



**Art. PSS**  
Pompa a staffa  
All purpose  
Pump



**Art. 2005**  
Confezione 12 Aghi  
con valvola  
per gonfiatura palloni  
Ø filettatura mm.5  
Set 12 Needles  
with valve  
for inflating balls  
Ø 5 mm. thread

pg.19

**Art. 2005RC**  
Ago di ricambio  
per compressore Art. 106  
Ø filettatura mm.7,5  
Spare needle  
for electric inflator Art. 106  
Ø 7,5 mm. thread



**Art. 104-T**  
Pompetta in gomma soft  
con ago e valvola di sfiato  
ideale per gonfiatura  
palloni in gomma  
Soft Pump with needle  
and valve  
for inflating rubber balls

## CRONOMETRI - ROTELLE METRICHE - CONTAMETRI Chronometers - Meter Counter - Measuring Tapes

I MODELLI  
DEI CRONOMETRI  
POSSONO  
VARIARE  
MODELS MAY  
CHANGE

pg.19



**Art. CRN.E**  
Cronometro digitale  
1/100 sec.  
Digital Chronometer  
1/100 sec.



**Art. CR032**  
Cronometro al quarzo  
a 30 memorie  
resistente all'acqua  
Quartz Chronometer  
30 memories water resistant



**Art. CMT** Contametri fino a m. 9999  
Meter Counter (until m. 9999)



**Art. PR20**  
Rotella Metrica  
in fibra m. 20  
Fiber measuring tape 20 m.

**Art. PR50**  
Rotella Metrica  
in fibra m. 50  
Fiber  
measuring tape  
50 m.

**Art. PR100**  
Rotella Metrica  
in fibra m. 100  
Fiber measuring tape 100 m.

## PALLONI CALCIO - Soccer Balls



### Art. GPA4 / GPA5

Pallone calcio Gems Viper Olimpico da allenamento in PU n. 4 e n. 5

vari colori

Ball Gems in PU size 4 and 5 various colors

pg.19



### Art. GPF5

Pallone calcio Gems Viper Olimpico da allenamento in PU n. 5

GIALLO FLUO

Ball Gems in PU size 5 fluorescent yellow

**New!**



### Art. 1000MS4

Pallone calcio da allenamento Molten misto TPU 1000MS n. 4 (Europa League replica)  
Molten training ball TPU size 4 (Europa League replica)



### Art. 1000MS5

Pallone calcio da allenamento Molten misto TPU 1000MS n. 5 (Europa League replica)  
Molten training ball TPU size 5 (Europa League replica)



### Art. NKPA4 / NKPA5

Pallone calcio Nike Pitch Team colore bianco o arancio n. 4 e n. 5  
Nike training ball size 4 and 5

pg.20



### Art. GPRZX

Pallone calcio Gems Raptor ZX da gara FIFA Quality Pro in PU n. 5  
Ball Gems in PU size 5



pg.19

### Art. F5V48TR

Pallone calcio Molten n. 5 F5V4800 "Trofeo" per allenamento professionisti e gare ufficiali categorie inferiori  
Molten Soccer Ball F5V4800 "Trofeo" size 5

## PALLONI CALCETTO, DA PALLEGGIO E SPECIALI - Futsal and rubber balls



pg.19

**Art. GPPC3**  
Pallone Gems Bomber  
Primi Calci in TPU n. 3  
Ball Gems in TPU size 3



pg.20

**Art. GBLD**  
Pallone calcetto Gems  
Blade a rimbalzo  
controllato n. 4  
Futsal Ball Gems size 4



pg.20

**Art. GPCV**  
Pallone calcetto Gems Vertigo  
a rimbalzo controllato n. 4  
Futsal Ball Gems size 4



**Art. M390P**  
Pallone calcetto Molten  
modello F9U2000 UEFA  
rimbalzo controllato  
Molten Futsal Ball F9U2000



**Art. GPC8**  
Pallone calcio a 8 Gems Raptor C8  
in PU n. 4,5  
Ball Gems in PU size 4,5



**Art. MTHO**  
Pallone calcetto Molten  
modello F9U4800 UEFA  
rimbalzo controllato  
(Thorax)  
Molten Futsal Ball  
F9U4800



pg.20

**Art. 26854**  
Pallone feltro indoor n. 4  
a rimbalzo normale  
Indoor Ball size 4



**Art. 45862**  
Pallone feltro indoor  
n. 4 a rimbalzo controllato  
Indoor slow rebound  
Ball size 4





pg.20

**Art. ULT46-3**  
**Pallone calcetto**  
**in gomma TRIAL triplo**  
**strato rimbalzo controllato**  
**gr.380 - diam. cm.19,9**  
 Futsal Ball slow rebound  
 Trial rubber



**Art. 1935S**  
**Pallone calcio in gomma**  
**monostrato n. 3**  
**colore giallo**  
 Rubber soccer Ball  
 single stratum size 3  
 color yellow



pg.21

**Art. BYCC**  
**Pallone calcio bicolore**  
**gomma Trial Ø cm.21,5 gr. 420**  
 Trial rubber bicoloured ball



**Art. V45/V44/V42/V41/V40**  
**Palloni calcio in gomma Trial monostrato n. 1 - 2 - 3 - 4 - 5**  
**(misura 5 solo nel colore bianco)**  
 Rubber soccer Balls single stratum Trial size 1 - 2 - 3 - 4 - 5  
 (size 5 only in white color)

pg.20



**Art. ULT42-3/ULT41-3**  
**ULT40-3**  
**Palloni calcio in gomma**  
**Trial triplo strato**  
**n. 3 - 4 - 5**  
 Rubber soccer Balls  
 triple stratum Trial  
 size 3 - 4 - 5

**Art. ULTST3/ULTST4/**  
**ULTST5**  
**Palloni Trial SILVER**  
**STREET n. 3 - 4 - 5**  
**doppio strato**  
 SILVER STREET Trial balls  
 size 3-4-5 double stratum



**Art. TRILO**  
**Pallone calcio Trial**  
**TRILO n. 4,5**  
**doppio strato**  
**limita il trauma dovuto**  
**all'impatto con la palla**  
 Soccer Ball Trial TRILO  
 size 4,5 double stratum  
 softens ball contact



**Art. B703390**

**Pallone in pelle sintetica gr.1000**  
Training Ball  
in synthetic leather 1000 gr.



**Art. ULTS40**

**Pallone in gomma Trial**  
**allenamento potenziato doppio strato**  
Ø cm.21,5 gr.630 (+50%)  
Trial heavy rubber ball double stratum



**Art. ULTD40**

**Pallone in gomma Trial**  
**allenamento potenziato**  
**doppio strato**  
Ø cm.21,5 gr.840 (+100%)  
Trial heavy rubber ball  
double stratum

pg.20

pg.21



**Art. TRBC**

**Pallone Reaction Ball Trial**  
**doppio strato rimbalzo e traiettorie**  
**imprevedibili per calcio**  
Trial Reaction Ball unpredictable  
rebounds for soccer double stratum



**Art. B703315**

**Pallone per allenamento portieri**  
**rimbalzo irregolare in pelle sintetica**  
Crazy Goalkeeper Ball  
irregular rebounds in synthetic leather



**Art. B703316**

**Reflex ball**  
**pallone prismatico**  
**in pelle sintetica**  
Prismatic ball in  
synthetic leather



pg.20

**Art. 149S14**

**Pallone in**  
**gommapiuma Ø cm. 14**  
Foam rubber ball Ø 14 cm.



**Art. 149S**

**Pallone in**  
**gommapiuma Ø cm. 20**  
Foam rubber ball Ø 20 cm.



pg.21

**Art. E48**

**Pallone sonoro Trial**  
**per non vedenti**  
Ø cm.22 - gr.470  
Trial rattle ball for blind people

## PALLE MEDICHE - Medicine Balls



pg.21

**Art. AHF-105 / AHF-106 / AHF-107 / AHF-108 / AHF-109**

**Palle Mediche  
rigonfiabili e rimbalzanti  
Kg. 1 - 2 - 3 - 4 - 5  
ad alto grip colore nero  
Medicine Balls  
inflatable and rebounding  
high grip in black color**



**Art. 048 / 050 / 051 / 052 / 053**

**Palle Mediche rigonfiabili  
e rimbalzanti Trial  
kg. 1 - 2 - 3 - 4 - 5  
(il colore varia  
a seconda del peso)  
Trial Medicine Balls  
inflatable and rebounding  
different colors for different weights**



**Art. PTI.M2 / ... / PTI.M10**

**Palle Mediche con maniglie  
kg. 2 - 4 - 6 - 8 - 10  
(il colore varia  
a seconda del peso)  
Medicine Balls with handles  
different colors for different weights**

**Art. AHF-048/.../AHF-097**

**SLAM BALL  
kg. 2 - 3 - 4 - 5 - 6 - 7 - 8  
9 - 10 - 12 - 15**



pg.21 pg.22



**Art. AHF-224/.../AHF-232**

**WALL BALL  
kg. 3 - 4 - 5 - 6 - 7 - 8  
9 - 10 - 12**



pg.12

**Art. KEB4/KEB6/KEB8/KEB10/KEB12/KEB16/KEB20/KEB24**

**Kettlebell in ghisa verniciata con base in gomma  
kg. 4 - 6 - 8 - 10 - 12 - 16 - 20 - 24  
Painted cast iron Kettlebells - rubber base**

**Art. RVKEB  
Rastrelliera verticale  
porta kettlebell/  
palle mediche  
(8 posti)  
8-seater vertical rack  
for cast iron  
Kettlebells/  
Medicine Balls**



**Art. OV500 / OV1 / OV2 / OV3 / OV4 / OV5**  
**Over Ball Trial kg.0,5 - 1 - 2 - 3 - 4 - 5  
con impugnatura anatomica  
Over Ball Trial**

pg.21



**Art. WMD100 / WMD200  
WMD300 / WMD400 / WMD500**  
**Palle Mediche morbide Bubble  
Trial - kg. 1 - 2 - 3 - 4 - 5  
Soft Trial Medicine Bubble Balls  
kg. 1 - 2 - 3 - 4 - 5**



**New!**

**Art. SKN05 / SKN1 / SKN2 / SKN3 / SKN4 / SKN5**

**Palle mediche SKIN BALL riempite con acqua demineralizzata colorata - peso kg. 0,5-1-2-3-4-5**

SKIN BALL Medicine balls filled with demineralized coloured water - weight 0,5-1-2-3-4-5 Kg.

pg.21

Grazie a queste nuove palle mediche gli atleti utilizzano carichi non inerti ma dinamici, effettuando esercizi di forza coordinata nuovi e destabilizzanti. La massa oscillante all'interno della palla medica SKIN BALL impone, sia in fase di lancio che di carico, adattamenti muscolari e coordinativi istantanei la cui intensità è variabile, e quindi non prevedibile. Inoltre, per i più giovani le palle mediche SKIN BALL sono molto efficaci per la memorizzazione della tecnica e per migliorare la conoscenza ed il controllo del proprio corpo. È possibile gonfiare e sgonfiare tutte le SKIN BALL variandone così la sofficietà

The new SKIN BALL medicine balls allow new exercises for muscle strength, equilibrium and coordination.

The liquid inside these balls makes them dynamic weights that require new rapid and adapting movements both when throwing and when lifting. Younger players will also improve and memorize body movements enhancing their equilibrium. These balls can be inflated or deflated so that softness will change

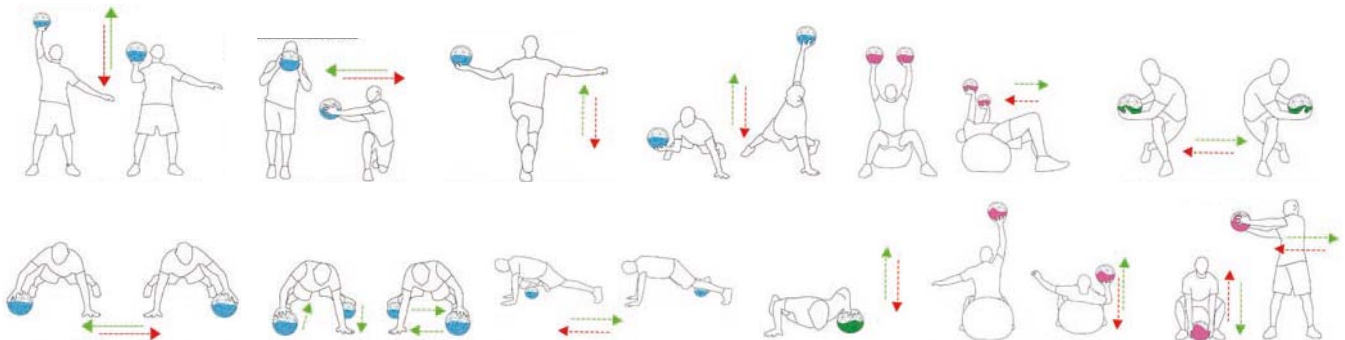

**Con le palle mediche SKIN BALL è possibile effettuare un allenamento dinamico utile per il rafforzamento degli arti inferiori e superiori, e per migliorare l'abilità nel lancio e nella presa**

With SKIN BALL you can run a dynamic training good for strengthening the lower and upper limbs, and to increase the ability of making throws and holds

**Art. POL1 / POL1.5 / POL2 / POL3 / POL3.5**

**POLIBOLO - Over Ball Trial a massa oscillante (riempite con acqua distillata) peso kg.1 - 1,5 - 2 - 3 - 3,5**

POLIBOLO - Over Ball Trial filled with distilled water - weights 1 - 1,5 - 2 - 3 - 3,5 Kg.



**Le Over Ball e le Polibolo possono essere utilizzate sia come manubri sia come palle mediche**

Over Balls and Polibolos can be used both as dumb bells and medicine balls

## PALLE RITMICHE, PSICOMOTORIE E LUDICHE - Rhythmic and Gym Balls



**Art. GS42/GS41/GS40/GS39** Palle Ritmiche Trial - Trial Rhythmic Balls gr. 400-350-250-150



**Ideali per trattamento  
fisioterapico,  
equilibrio, stretching,  
tonificazione, attività  
aerobica, scarico  
vertebrale,  
riscaldamento,  
potenziamento  
muscolare ...**

Very useful for injury  
recovery, equilibrium,  
stretching, muscle  
training, aerobic activity,  
warm up ...



**Art. 30934/30935/30936/31036**

### Palle psicomotorie monostrato

Gym balls single stratum

Ø cm. 55

Ø cm. 65

Ø cm. 75

Ø cm. 85

**Art. V10/V11/V12/V13/V14/V15/  
V16/V17/V18/V19**

### Palle psicomotorie Trial in gomma doppio strato (il colore varia a seconda del diametro)

Trial Gym balls  
in double stratum rubber

Ø cm.14-18-22-30

42-53-65-90-120-150



● pg.22

**Art. V-LAB**

### Palla psicomotoria Trial La Ball con range di possibile utilizzo da cm.50 a cm.70 struttura instabile in gomma doppio strato particolarmente elastica

Gym ball Trial La Ball  
inflatable from 50 to 70 cm.

changing shape

concept in very elastic

double stratum rubber



**Art. ULTbbs3**  
**Pallone Jumbo Trial a 3 strati**  
diam. cm.28 - gr.280  
Jumbo Trial Ball triple stratum

pg.21



**Rimbalzo normale con diametro maggiorato per favorire l'apprendimento del bambino**  
Normal rebound with bigger diameter for youngest training and fun



**Art. BTR1**  
**Palla sensoriale Ø cm. 21 - gr. 420**  
Sensory Ball Ø cm.21 - gr. 420



**Le palle sensoriali rimbalzanti esaltano la tattilità e rappresentano anche uno strumento di automassaggio a pressione**  
To stimulate touch and also useful massage tools



pg.20

**Art. BTR2**  
**Palla sensoriale Ø cm.12 - gr. 180**  
Sensory Ball Ø cm.12 - gr. 180

**Allenando la visibilità laterale migliorano la percezione dello spazio, i movimenti e la sicurezza nella vita quotidiana**  
For space perception, coordination and everyday life safety

pg.8



**Art. TLV16**  
**Palle morbide Trial per allenamento della visibilità laterale Set di 6 Palle diametro cm. 16 gr. 110**  
Soft balls for lateral visibility training Set of 6 balls  
16 cm. diameter - 110 gr.

**Art. TLV21**  
**Set di 6 Palle diametro cm. 21 gr. 160**  
Soft balls for lateral visibility training Set of 6 balls  
21 cm. diameter - 160 gr.



**Art. BS1T**  
**PALLONE BASIC jelly touch**  
Ø 12/16 cm. gr.140 - colore verde  
Basic Ball green color

pg.21

**Art. BS2T**  
**PALLONE BASIC jelly touch**  
Ø 16/22 cm. gr.180 - colore arancio  
Basic Ball orange color

**Art. BS3T**  
**PALLONE BASIC jelly touch**  
Ø 22/28 cm. gr.240 - colore rosso  
Basic Ball red color

## BORSE - Bags

### QUANTITÀ PER MODELLO E COLORE MULTIPLA DI 5 PEZZI

Quantity by model and color  
multiple of 5 pieces

**COLORI DISPONIBILI**  
rosso, royal, navy (no Small),  
nero, verde, bordeaux  
Colors: red, royal, black,  
green, navy (no Small),  
bordeaux



**Art. STD02**  
Borsa Big  
doppio fondo  
cm. 53,5x45h.x32,5  
poliestere 600  
Soccer bag large

**Art. STD09**  
Borsa Medium  
doppio fondo  
cm. 50x42h.x30  
poliestere 600  
Soccer bag medium

**Art. STD03**  
Borsa Small  
doppio fondo  
cm. 47,5x40h.x26,5  
poliestere 600  
Soccer bag small

pg.23

### QUANTITÀ PER COLORE MULTIPLA DI 5 PEZZI

Quantity by color  
multiple of 5 pieces



#### Art. STD04

Borsa TOP bicolore in poliestere 600 con fondo rigido h. 15 cm. con tracolla e porta nome, tre tasche, dim. cm. 53,5x45h.x32,5  
colori: navy/royal, nero/grigio, navy/rosso, nero/verde, navy/giallo, nero/rosso, nero/bordeaux  
Soccer Bag bicolor in polyester 600 1 pocket size 53,5x45h.x32,5 cm.  
colors: navy/royal, black/grey, navy/red, black/green, navy/yellow, black/red, black/bordeaux

### QUANTITÀ PER COLORE MULTIPLA DI 15 PEZZI

Quantity by color  
multiple of 15 pieces



#### Art. STD18

Zainetto doppio fondo poliestere 600  
2 tasche - cm. 34x47h.x24 fondo rigido  
colori: royal, nero, rosso,  
navy, verde, bordeaux  
Rucksack in 6 different colors



**Art. STD05**  
**Borsa Portamute cm. 72x35h.x28**  
**poliestere 600 - colore nero**  
Soccer bag for uniforms dim. 72x35h.x28 cm.  
color black

**QUANTITÀ PER COLORE  
MULTIPLA DI 5 PEZZI**

Quantity by color  
multiple of 5 pieces

pg.23



**Art. STD08**  
**Borsa palestra poliestere 600 cm.60x30h.x32**  
**con due tasche e vano portascarpe**  
**colori rosso, royal, navy, nero**  
Gym Bag color black, red, royal, navy



**Art. ZBGL**  
**BORSA/ZAINETTO monocolore economica**  
**cm. 36x38 vari colori - serigrafabile su richiesta**  
Backpack one color with your logo on request



**Art. STD07**  
**Borsa Medica dim. cm. 40x28,5h.x20**  
**poliestere 600 - colore nero**  
Bag for First Aid 40x28,5h.x20 cm.



**Art. BMD**  
**Borsa Medica dim. cm. 37x29h.x17**  
Bag for First Aid 37x29h.x17 cm.



## CESTE PORTAPALLONI - Baskets for balls



**Art. FP400**

**Cesta portapalloni a soffietto in alluminio**  
**cm. 60x60x100h pieghevole con sacca**  
 Basket for balls in aluminium  
 60x60x100h cm. foldable with bag



**Art. F401**

**Cesta Portapalloni in ferro verniciato**  
**cm. 80x55x60h pieghevole**  
 Basket for Balls in painted steel 80x55x60h cm. foldable



pg.22

**Art. F402**

**Cesta Portapalloni**  
**in ferro zincato**  
**cm. 60x60x90h pieghevole**  
 Basket for Balls  
 in galvanized steel  
 60x60x90h cm. foldable

**Art. F404 Cesta Portapalloni**  
**in rete metallica verniciata**  
**cm. 70x70x70h pieghevole**  
**con lucchetto**  
 Basket for Balls  
 painted with metallic net  
 70x70x70h cm.  
 foldable, with lock



**Art. F403G Cesta Portapalloni**  
**in ferro verniciato cm. 100x75x90h**  
**pieghevole con lucchetto**  
 Basket for Balls in painted steel  
 100x75x90h cm. foldable, with lock



pg.22

**Art. F403ZN**  
**Cesta Portapalloni in ferro zincato**  
**cm. 100x75x90h**  
**pieghevole con lucchetto**  
 Basket for Balls in galvanized steel  
 100x75x90h cm. foldable, with lock



pg.23

**Art. NCPR**  
**Sacca portapalloni in nylon**  
**con maniglie, tracolla e ruote**  
 Bag for balls with handles and wheels

## PORTE CALCIO - Soccer Goals



### Art. 109

**Coppia Porte fisse regolamentari in lega leggera costruite secondo lo standard europeo di qualità UNI EN 748 con paletti tendirete posteriori in acciaio zincato, pali sezione mm. 120x100 verniciati con smalto acrilico non tossico, ganci reggirete e bussole per interrimento pali incluse (ribaltine alzarete non incluse)**

Pair of regular Goals in light alloy manufactured according to the UNI EN 748 European standard of quality norms. Pipe section 120x100 mm. painted with non toxic white. Net holders, rear posts and underground sockets included (liftable ground backframes not included)

pg.23

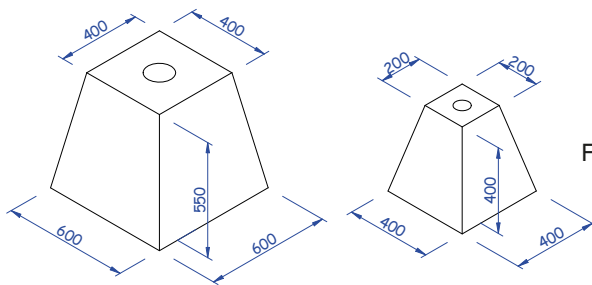

### Ancoraggio tramite plinti in cemento (non inclusi)

Fixing with concrete blocks (not included)

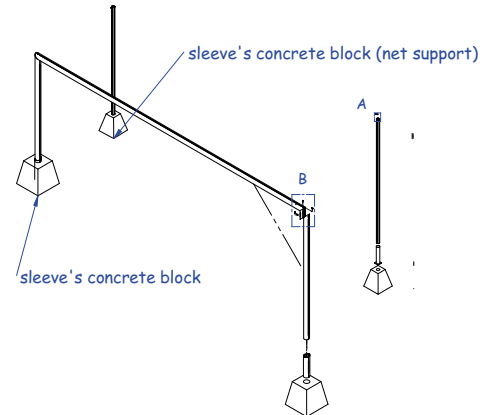

**ATTENZIONE: in caso di ordine errato da parte del Cliente le porte, una volta consegnate, non possono essere rese**

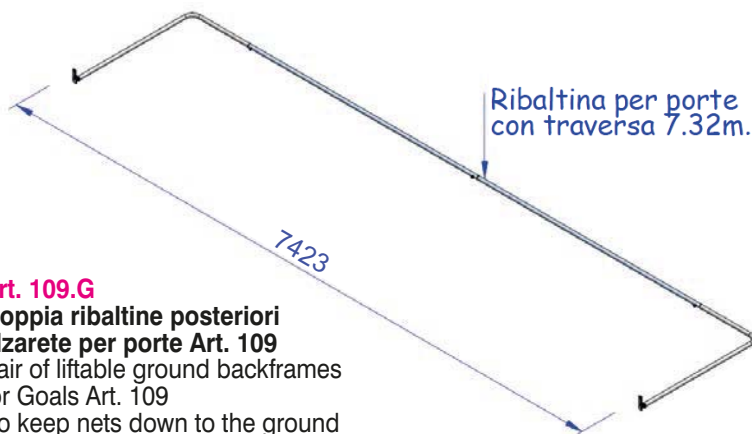

### Art. 109.G

#### Coppia ribaltine posteriori alzarete per porte Art. 109

Pair of liftable ground backframes for Goals Art. 109 (to keep nets down to the ground and also to raise them up when cutting grass)

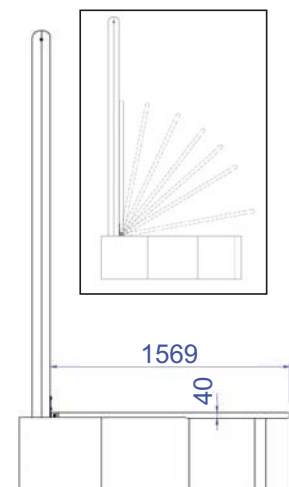

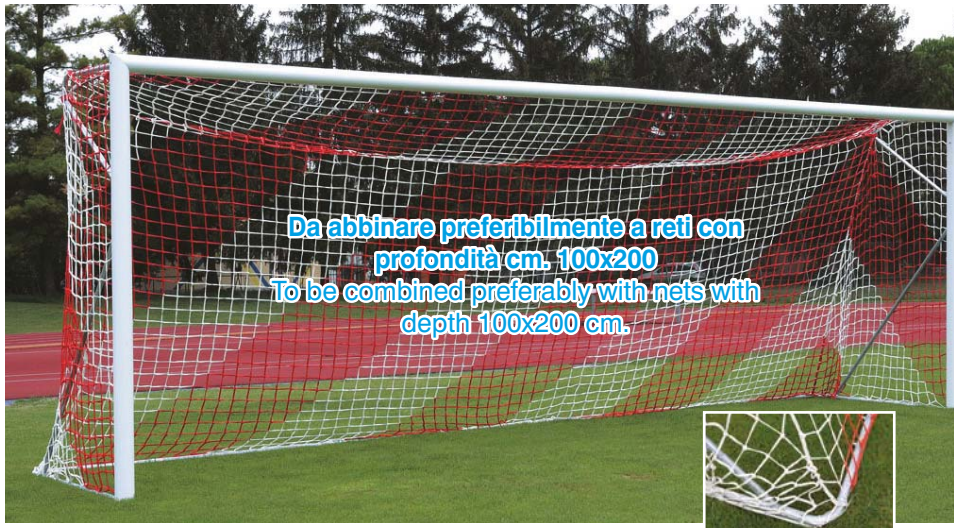

**Art. 120-RG**  
Coppia ruote per porte trasportabili regolamentari Art. 110FG, 110-D e 110G  
Pair of wheels for regular size transportable goals Art. 110FG, 110-D and 110G

**Art. 110FG** Coppia Porte Trasportabili in lega leggera dimensioni regolamentari profilo sezione mm. 120x100 verniciate con smalto acrilico non tossico base di appoggio posteriore con tubo tondo in ferro - a norma UNI EN 748  
Pair of transportable Goals in light alloy regular size, pipe section mm. 120x100 painted with non toxic white - back frame in round iron pipe - UNI EN 748 standard



**LE PORTE TRASPORTABILI IN FASE DI GIOCO DEVONO ESSERE ZAVORRATE SULLA BASE POSTERIORE O FISSATE A TERRA CON PICCHETTI PER MOTIVI DI SICUREZZA. LE RUOTE GOMMATE SONO OPTIONAL**

Transportable goals must always be anchored to the ground by sacs of sand or metal pegs, for safety reasons. Wheels are optional

**Art. 110-D**  
Coppia Porte Trasportabili dim. regolamentari in lega leggera profilo sezione mm. 120x100 - verniciate con smalto acrilico non tossico base di appoggio posteriore con profilo ovale in alluminio mm. 65x55 - a norma UNI EN 748  
Pair of transportable Goals in light alloy regular size, pipe mm. 120x100 painted with non toxic white - back frame in aluminium ovoidal pipe 65x55 mm.



**Art. AMCP**  
Carrello per il trasporto di porte (trasportabili) regolamentari e ridotte - brevettato  
Patented trolley for moving official and junior size transportable goals

● pg.26



**Art. 110G** Coppia Porte Trasportabili in lega leggera dimensioni regolamentari profilo mm. 120x100 verniciate con smalto acrilico non tossico, base di appoggio posteriore con profilo in lega mm. 120x100 - a norma UNI EN 748 e FIGC  
 Pair of transportable Goals in light alloy regular size, pipe mm. 120x100, painted with non toxic white - back frame pipe 120x100 mm. - UNI EN 748 and FIGC standard

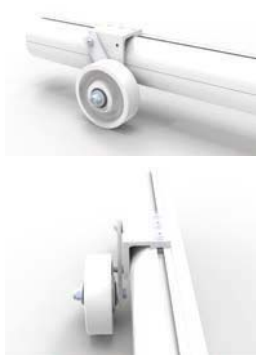

**Art. 110GMR** Set 4 ruote per porte trasportabili regolamentari Art. 110G (2 set per 1 coppia di porte). Ciascuna ruota in dotazione ha una posizione di riposo e una posizione di trasporto (per passare dall'una all'altra occorre far ruotare il dispositivo intorno al perno). Dunque, le ruote restano sempre fissate al telaio posteriore della porta  
 Set of 4 wheels for regular size transportable goals Art. 110G (2 set for 1 pair of goals). Each wheel remains fixed to the back ground frame also when goals are in use, in stand by position. To switch the wheel into transport position you have to turn it around the pivot

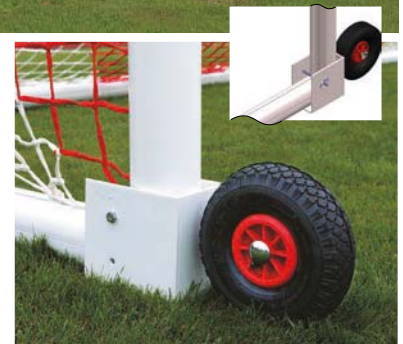

pg.24

**Art. 120-RG**  
 Coppia ruote per porte trasportabili regolamentari Art. 110FG, 110-D e 110G  
 Pair of wheels for regular size transportable goals Art. 110FG, 110-D and 110G

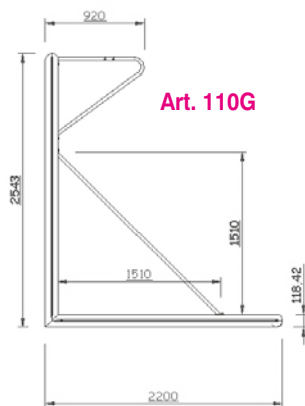

Art. 110G

**Art. 4580M**  
 Mollone per ancoraggio porte trasportabili regolamentari e ridotte su terreno naturale  
 Spring for goal anchoring on natural grass

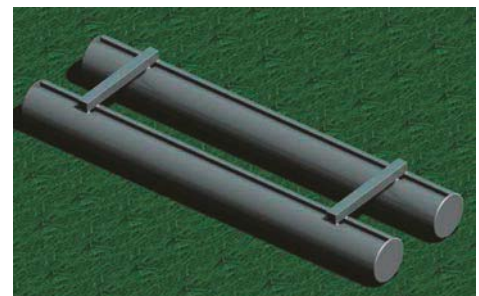

**Art. AFC**  
 Zavorra in alluminio per ancoraggio porte trasportabili regolamentari e ridotte  
 Aluminium weighted pipes for goal anchoring

**ATTENZIONE: in caso di ordine errato da parte del Cliente le porte, una volta consegnate, non possono essere rese**

**Art. DSSCE**  
 Sacco zavorra vuoto (da riempire con sabbia) per ancoraggio porte trasportabili regolamentari e ridotte  
 Empty Ballast Bag (to be filled with sand) for goal anchoring

pg.26



**Art. DSS20**  
 Sacco zavorra kg. 20 (riempito con sabbia) per ancoraggio porte trasportabili regolamentari e ridotte  
 Ballast Bag weight 20 Kg. for goal anchoring

**Porte fisse (con bussole e pali da interrare) e trasportabili in lega leggera o acciaio, sezione tubo mm. 120x100 o mm.80 - dimensioni m. 3x2 - m. 4x2 - m. 5x2 - m. 6x2**  
 Fixed and transportable Goals in light alloy or painted steel, pipe section 120x100 mm. or 80 mm. dimensions m. 3 x 2 - m. 4 x 2 - m. 5 x 2 - m. 6 x 2

pg.24 pg.25



Art. 114-T  
 Art. 118-G  
 Art. 116-TDV  
 Art. 120-TG

Con distanziale a terra posteriore in tubo tondo  
 With round pipe ground base

**ATTENZIONE: in caso di ordine errato da parte del Cliente le porte, una volta consegnate, non possono essere rese**

**Art. 114-T**

**Coppia Porte m. 4 x 2 a traversa intera in acciaio trasportabili tubo sezione 80 mm.**  
 Pair of Goals m. 4 x 2 - 1 piece crossbar in painted steel, transportable, pipe 80 mm.

**Art. 118-G**

**Coppia Porte m. 4 x 2 a traversa intera in lega di alluminio trasportabili tubo sezione 80 mm.**  
 Pair of Goals m. 4 x 2 - 1 piece crossbar in light alloy, transportable, pipe 80 mm.

**Art. 116-TDV**

**Coppia Porte m. 5 x 2 a traversa divisa in lega di alluminio trasportabili tubo 80 mm.**  
 Pair of Goals m. 5 x 2 - crossbar in 2 pieces in light alloy, transportable, pipe 80 mm.

**Art. 120-TG**

**Coppia Porte m. 6 x 2 a traversa divisa in lega di alluminio trasportabili tubo sezione 80 mm.**  
 Pair of Goals m. 6 x 2 - crossbars in 2 pieces in light alloy, transportable, pipe 80 mm.

**Art. 118A**  
**Coppia Porte m. 4 x 2 a traversa divisa in lega di alluminio trasportabili tubo 80 mm. con base posteriore a sezione quadra**  
 Pair of Goals m. 4 x 2 - crossbars in 2 pieces in light alloy, transportable, pipe 80 mm. with square pipe ground bases

**Art. 1129A**  
**Coppia Porte m. 5 x 2 a traversa divisa in lega di alluminio trasportabili tubo 80 mm. con base posteriore a sezione quadra**  
 Pair of Goals m. 5 x 2 - crossbars in 2 pieces in light alloy, transportable, pipe 80 mm. with square pipe ground bases

**Art. 1121A**  
**Coppia Porte m. 6 x 2 a traversa divisa in lega di alluminio trasportabili tubo 80 mm. con base posteriore a sezione quadra**  
 Pair of Goals m. 6 x 2 - crossbars in 2 pieces in light alloy, transportable, pipe 80 mm. with square pipe ground bases



Art. 118A  
 Art. 1129A  
 Art. 1121A

Da abbinare esclusivamente a reti con profondità cm. 100x160  
 To be combined only with nets with depth 100x160 cm.

Base posteriore a sezione quadra  
 Reinforced ground base

**LE PORTE TRASPORTABILI IN FASE DI GIOCO DEVONO ESSERE ZAVORRATE SULLA BASE POSTERIORE O FISSATE A TERRA CON PICCHETTI PER MOTIVI DI SICUREZZA. LE RUOTE GOMMATE SONO OPTIONAL**  
 Transportable goals must always be anchored to the ground by sacs of sand or metal pegs, for safety reasons. Wheels are optional



**Art. 120-R**  
**Coppia ruote per porte trasportabili ridotte Art. 118A, 1129A, 1121A**  
 Pair of wheels for reduced size transportable goals Art. 118A, 1129A, 1121A

pg.25



**Art. 4640**  
**Coppia ruote per porte trasportabili ridotte Art. 114-T, 118-G, 116-TDV, 120-TG**  
 Pair of wheels for reduced size transportable goals Art. 114-T, 118-G, 116-TDV, 120-TG



Le porte ridotte sono disponibili anche nel modello fisso con bussole e pali da interrare  
 Available also fixed models with underground sockets



**Art. 119G**  
**Art. 120-G**

Da abbinare esclusivamente a reti con  
profondità cm. 100x160  
To be combined only with nets with  
depth 100x160 cm.

**Art. 119G** Coppia Porte m. 5 x 2 a traversa divisa  
in acciaio trasportabili tubo 80 mm.  
Pair of Goals m. 5 x 2 crossbar in 2 pieces in painted steel,  
transportable, pipe 80 mm.

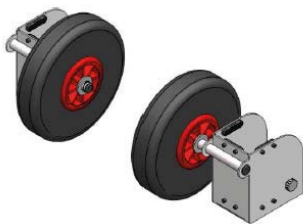

**Art. 240RU** Coppia ruote  
gommate con staffa per porte  
**Art. 119G/120-G**  
Pair of wheels for transportable  
goals Art. 119G/120-G



**Art. 240AF** Kit di fissaggio a  
terra per porte Art. 119G/120-G  
Ground anchoring kit for  
transportable goals  
Art. 119G/120-G

**Art. 120-G** Coppia Porte m. 6 x 2 a traversa divisa  
in acciaio trasportabili tubo sezione 80 mm.  
Pair of Goals m. 6 x 2 crossbars in 2 pieces  
in painted steel, transportable, pipe 80 mm.

pg.24 pg.25

**Art. 241C** Chiave per kit  
di fissaggio Art. 240AF  
Key for ground anchoring  
kit Art. 240AF



**ATTENZIONE:**  
in caso di ordine errato da parte del Cliente  
le porte, una volta consegnate,  
non possono essere rese



**Art. 122G**  
**Art. 121G**

**Art. 122G**  
**Coppia Porte Calcetto m. 3 x 2 trasportabili**  
in acciaio verniciato tubo sezione 80 mm.  
Pair of Goals m.3x2 transportable in painted steel pipe 80 mm.

**Art. 121G**  
**Coppia Porte Calcetto m. 3 x 2 trasportabili**  
in lega leggera tubo sezione 80 mm.  
Pair of Goals m.3x2 transportable in light alloy pipe 80 mm.

pg.25

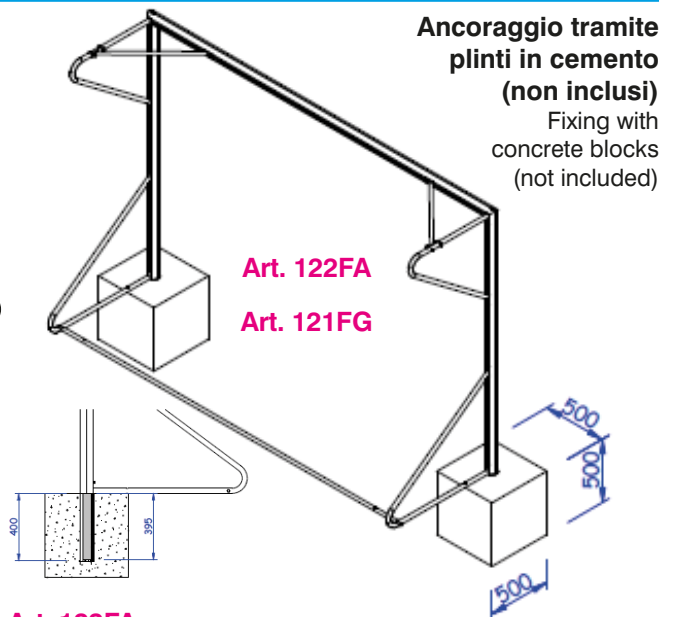

**Ancoraggio tramite  
plinti in cemento  
(non inclusi)**  
Fixing with  
concrete blocks  
(not included)

**Art. 122FA**  
**Coppia Porte Calcetto m. 3 x 2 fisse con bussole da**  
interrare in acciaio verniciato tubo 80 mm.  
Pair of Goals m.3x2 fixed in painted steel pipe 80 mm.

**Art. 121FG**  
**Coppia Porte Calcetto m. 3 x 2 fisse con bussole da**  
interrare in lega leggera tubo 80 mm.  
Pair of Goals m.3x2 fixed in light alloy pipe 80 mm.

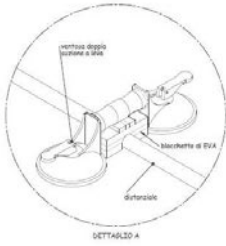

**Art. VTCL**  
**Ventosa doppia per ancoraggio a terra**  
**porte calcetto su superfici indoor lisce**  
**(si consigliano 2 kit per ciascuna porta)**  
 Ground anchoring suckers for reduced goals  
 to be used upon indoor smooth floors  
 (it takes 2 kits for every goal)

pg.25 pg.26



**Art. DSSCE**  
**Sacco zavorra vuoto**  
**(da riempire con sabbia)**  
**per ancoraggio**  
**porte trasportabili**  
**regolamentari e ridotte**  
 Empty Ballast Bag  
 (to be filled with sand)  
 for goal anchoring



**Art. DSS20**  
**Sacco zavorra kg. 20**  
**(riempito con sabbia)**  
**per ancoraggio**  
**porte trasportabili**  
**regolamentari e ridotte**  
 Ballast Bag weight 20 Kg.  
 for goal anchoring

**Art. PC04**  
**Picchetto in alluminio**  
**per ancoraggio**  
**di porte ridotte**  
**con distanziale sottile**  
**su terreno naturale**  
 Aluminium anchoring hook  
 for reduced soccer goals  
 with thin pipe ground bases

**Art. AM01.7/.../AM01.3**  
**TUBO ZAVORRA in PVC diametro 50 mm. atossico,**  
**flessibile, modellabile, appesantito da composto**  
**ecologico (peso 6 Kg. per metro) resistente alle alte e**  
**basse temperature e ai raggi ultravioletti**  
**per porte ridotte mt. 3x2/4x2/5x2/6x2**  
**e regolamentari sia fisse che trasportabili**  
 Weighted soft Pipe 50 mm. diameter  
 (6 Kg. per meter) resistant to high/low  
 temperatures and ultra violet rays  
 for safe anchoring of transportable goals  
 m. 3x2/4x2/5x2/6x2 and official size goals  
 to the ground

pg.26



**Art. 353.G10 (modello 2010)**



**Art. 353.G13 (modello 2013)**

**Art. 353.G10 / 353.G13**  
**Serie 100 ganci reggirete di**  
**ricambio modello a rotazione**  
**per porte regolamentari o ridotte**  
 100 spare Net Holders  
 rotating model for regular  
 and reduced goals



pg.25

**Art. 353 Serie 100 ganci reggirete**  
**di ricambio modello con vite per porte**  
**regolamentari o ridotte**  
 100 spare Net Holders with screws  
 for regular and reduced goals



**Art. V590010**  
**Serie 100 ganci**  
**reggirete**  
**di ricambio**  
 100 spare  
 Net Holders



**Art. V680011 Serie 100 ganci**  
**reggirete di ricambio**  
**a base rotonda da fissare con viti**  
 100 spare Net Holders

**ATTENZIONE: verificate la tipologia dei ganci**  
**delle Vostre porte prima di ordinare i ricambi**  
 Please check the model of your holders  
 before ordering spares



**Art. GFG**  
**Gancio**  
**reggirete**  
**in ferro con**  
**piastrina**  
**di ricambio**  
 Spare iron  
 Net Holder



**Art. SC1051**  
**Serie 100 ganci**  
**reggirete**  
**di ricambio**  
 100 spare  
 Net Holders



**Art. 110BAG**  
**Serie 60 ganci**  
**reggirete**  
**di ricambio**  
 60 spare  
 Net Holders



pg.25

Ideale per uso  
privato  
Not for official  
matches

**Art. SG176**

**Porta m. 3x2 trasportabile  
in ferro verniciato,  
tubo sezione mm. 32  
completa di rete, ganci e  
picchetti**

3x2 meter transportable  
Goal in painted iron, pipe  
section 32 mm. complete  
with net and anchor pegs



pg.25

Ideale per uso  
privato  
Not for official  
matches

**Art. 500SG**

**Porta m. 3x2 trasportabile  
in ferro verniciato,  
tubo sezione mm. 50  
completa di rete, ganci e  
picchetti**

3x2 meter transportable  
Goal in painted iron, pipe  
section 50 mm. complete  
with net and anchor pegs

**ATTENZIONE: in caso di ordine errato da parte del Cliente  
le porte, una volta consegnate, non possono essere rese**

**PORTE BIFRONTALI in lega leggera o acciaio dimensioni m. 3x2 - 4x2 - 6x2**

Available 2 SIDE GOALS in light alloy or in painted steel dimensions m. 3 x 2 - 4 x 2 - 6 x 2

pg.26



**Art. 084**

**Porta bifrontale  
m. 4 x 2  
in lega leggera  
sezione tubo 50 mm.  
completa di rete**

Two Side Goal  
4 x 2 m. in light alloy  
pipe 50 mm.  
net included

**Art. 084AC**

**Porta bifrontale  
m. 4 x 2  
in acciaio verniciato  
sezione tubo 50 mm.  
completa di rete**

Two Side Goal  
4 x 2 m. in painted  
steel, pipe 50 mm.  
net included



## MINI PORTE Mini-goals



**Art. F214**  
Coppia Miniporte professionali  
in acciaio verniciato tubo sezione 80 mm.  
dimensioni m. 1,5 x 1 complete di reti  
Pair of professional steel Mini-goals  
pipe 80 mm. dimensions m. 1,5 x 1  
nets included



pg.26

**Art. F218**  
Coppia Miniporte professionali  
in acciaio verniciato  
tubo sezione 80 mm.  
dimensioni cm. 90x60  
complete di reti  
Pair of professional steel Mini-goals  
pipe 80 mm.  
dimensions 90x60 cm.  
nets included



**Art. 123C**  
Coppia Miniporte in acciaio verniciato m. 1,5 x 1  
complete di reti e picchetti  
Pair of Mini-goals m. 1,5 x 1  
in painted steel pegs and nets included



**Art. 123F**  
Coppia Miniporte in acciaio verniciato  
m. 1,5 x 1 complete di reti e picchetti  
Pair of Mini-goals m. 1,5 x 1 in painted steel  
pegs and nets included

pg.26



**Art. 124C**  
Coppia Miniporte m. 1,5 x 1,1 in PVC rinforzato tubo Ø 70 mm. complete di reti e picchetti  
Pair of PVC Mini-goals m. 1,5 x 1,1 pipe Ø 70 mm. pegs and nets included



**Art. 124**  
**Coppia Miniporte in polipropilene m. 1,5 x 1,1**  
**tubo Ø 40 mm. complete di reti**  
Pair of polypropylene Mini-goals m. 1,5 x 1,1  
pipe Ø 40 mm. - nets included



**Dimensioni porta ribaltata m. 1,5 x 0,80**  
Goal upside down dimensions 1,5 x 0,80 m.



**Art. A124**  
**Coppia Miniporte in alluminio m. 1,5 x 1,1**  
**tubo Ø 32 mm. complete di reti**  
Pair of aluminium Mini-goals m. 1,5 x 1,1  
pipe Ø 32 mm. - nets included



**Dimensioni porta ribaltata m. 1,5 x 0,80**  
Goal upside down dimensions 1,5 x 0,80 m.

pg.26



**Art. PUG**  
**Coppia Miniporte in nylon**  
**m. 1,83 x 1,07**  
**complete di reti,**  
**picchetti e borsa**  
Pair of nylon Mini-goals  
1,83 x 1,07 m.  
nets, pegs and bag included



**Art. IS215**  
**Miniporta in acciaio m. 2,15 x 1,52 completa di rete, parete con bersagli e rete di rimbalzo**  
Steel Mini-goal m. 2,15 x 1,52 - net, PVC target and rebounding net included

## MINIORTA CM.150x90 PIEGHEVOLE - Foldable 150x90 cm. mini-goal



**New!**

pg.26

Art. BG150

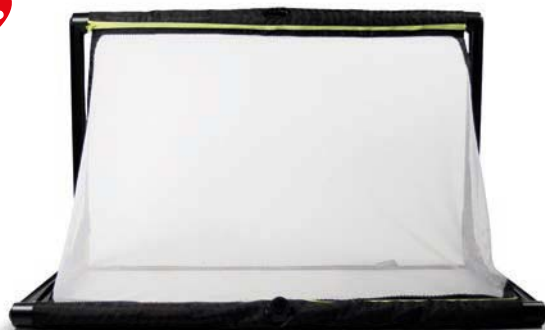

Questa miniporta da calcio pieghevole consente ad allenatori e giocatori di concentrarsi sugli esercizi fondamentali poiché per il montaggio sono richiesti solo 10 secondi. Il telaio facilmente trasportabile è durevole, sicuro e realizzato con una struttura in PVC resistente al calore. Esso è dotato di bobine progettate per tornare in posizione dopo una pallonata e, soprattutto, la porta rimane stabile senza necessità di ancoraggio a terra grazie al sistema a molla integrato.

A differenza di molte porte da calcio in metallo comunemente usate, questa miniporta in PVC è totalmente sicura e previene il rischio di infortuni qualora un giocatore andasse a sbatterci contro.

La rete della porta a tecnologia telescopica brevettata può essere personalizzata. È possibile infatti stamparvi il logo della propria squadra di modo che la porta diventi un utile strumento di marketing per le società sportive, ma anche per i partners esterni delle società stesse che desiderano investire in sponsorizzazioni smart.

La miniporta da calcio pieghevole può essere utilizzata sulle diverse tipologie di superfici (erba, sabbia, cemento, legno). Non ha bisogno di borsa dato che la sua resistente rete funge anche da rivestimento.

La miniporta da 150 cm x 90 cm si riduce ad una dimensione compatta di 180 cm x 15 cm x 10 cm, e le comode cinghie rendono il trasporto agevole visto che il peso è di soli 7 chilogrammi.

Le miniporte da calcio pieghevoli vengono utilizzate quotidianamente presso alcune delle più rinomate accademie e scuole calcio di club professionistici tra cui Chelsea, Barcellona, Ajax, Arsenal, Manchester United, Liverpool ed Everton. Sono approvate e raccomandate dalla Federcalcio catalana in Spagna, dalla Federazione norvegese, nonché dall'Oregon Youth Soccer Association.



**SI INSTALLA  
IN 10 SECONDI  
READY IN 10  
SECONDS**

**LEGGERA E  
COMODA PER  
IL TRASPORTO  
LIGHT AND  
COMFORTABLE  
FOR TRANSPORT**

**CON RETE  
PERSONALIZZABILE  
WITH  
CUSTOMIZABLE  
NET**



This foldable mini-goal allows coaches and players to focus on core exercises as only 10 seconds are required for assembly. The easily transportable frame is durable, safe and made with a heat resistant PVC construction. It's equipped with coils designed to return to position after a ball hit and, above all, the goal remains stable with no need to be anchored to the ground thanks to the integrated spring system.

Unlike many commonly used metal soccer goals, this PVC mini-goal is totally safe and prevents the risk of injury should a player bump into it.

The patented telescopic goal net can be customized. In fact, it's possible to print the logo of your team so that the goal becomes a useful marketing tool for sports clubs, but also for external partners who wish to invest in smart sponsorships.

The foldable mini-goal can be used on different surfaces (grass, sand, concrete, wood). It does not need a bag as its durable net also acts as a covering.

The 150 cm x 90 cm mini-goal is reduced to a compact size of 180 cm x 15 cm x 10 cm, and the comfortable straps make transport easy as the weight is only 7 kilograms.

Foldable mini-goals are used daily at some of the most renowned academies and soccer schools of professional clubs including Chelsea, Barcelona, Ajax, Arsenal, Manchester United, Liverpool and Everton. They are approved and recommended by the Catalan Football Association in Spain, the Norwegian Federation, as well as the Oregon Youth Soccer Association.



**RETI REGOLAMENTARI - Regular Nets**

Le reti a maglia esagonale sono tessute, quelle a maglia quadrata sono annodate (eccetto Art. B011)  
 Square mesh nets are knotted (except Art. B011)



**Art. B011**  
 polipropilene mm.5  
 maglia mm.120 mesh  
 colore bianco  
 white  
 certificate FIGC/LND  
 certified  
 profondità  
 cm.200x200 depth

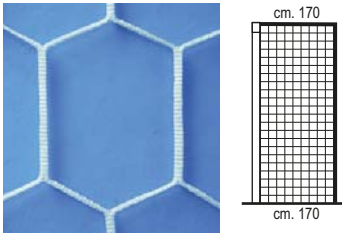
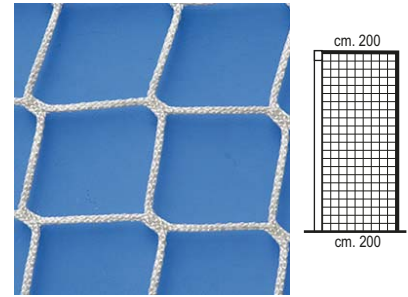

**Art. 125E**  
 polipropilene mm. 3  
 profondità  
 cm.170x170 depth

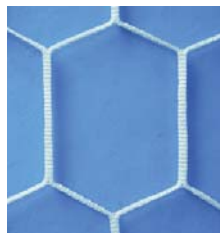

**Art. 125**  
 polipropilene mm. 4  
 profondità  
 cm.170x170 depth

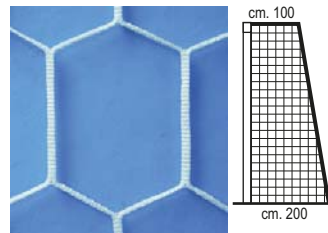

**Art. 126**  
 poliestere mm. 5  
 profondità  
 cm.100x200 depth

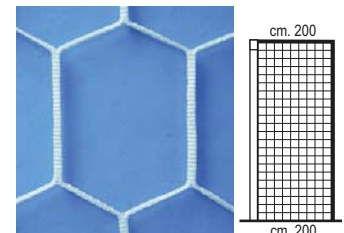

**Art. 127**  
 polipropilene mm. 5  
 profondità  
 cm.200x200 depth

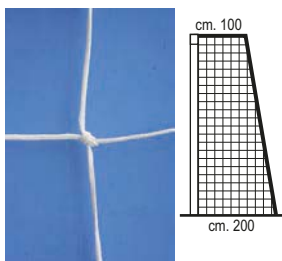

**Art. B19**  
 polietilene sp.mm.3,5  
 profondità  
 cm.100x200 depth

pg.27



**Art. 128E**  
 polietilene sp.mm.3,5  
 profondità  
 cm.200x200 depth

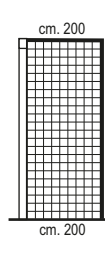

**Art. 128**  
 polietilene sp.mm.4,5  
 profondità  
 cm.200x200 depth



**Profondità:**  
 la prima grandezza indica  
 la sporgenza posteriore  
 della rete  
 ad altezza traversa,  
 la seconda grandezza  
 indica quella a terra  
 Depth: the first figure indicates  
 the rear depth of the net at  
 crossbar level, the second  
 figure indicates the rear depth  
 at ground

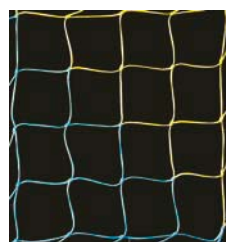

**Art. 128FR** Coppia reti annodate in polietilene mm.4 bianche o a strisce colorate (bianco-royal, bianco-rosso, giallo-royal) profondità cm.100x200 depth  
 Pair of nets polyethylene 4 mm. color stripes, knotted (available in white, white-royal, yellow-royal, white-red)

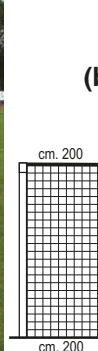
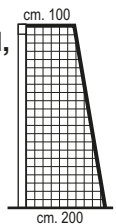

**Art. 128C** Coppia reti annodate in polietilene mm.3,5 a strisce colorate (bianco-royal, bianco-rosso, giallo-royal, rosso-blu, bianco-nero, bianco-verde) profondità cm.200x200 depth  
 Pair of nets polyethylene 3,5 mm. color stripes, knotted (available in white-royal, yellow-royal, white-red, white-black, white-green, red-blue)



**Art. 129T**  
 Coppia reti polipropilene mm.4 annodate a mano a strisce colorate (consigliabile per combinazioni di colori alternative a quelle degli Art.128FR e 128C) profondità cm.200x200 depth  
 Pair of nets with color stripes, hand knotted in various combinations

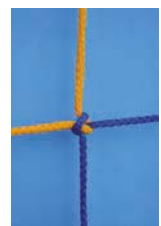

**RETI RIDOTTE - Reduced Size Nets - m.4x2/m.5x2/m.6x2/m.6x2,2/m.6,5x2,5**

**Profondità: la prima grandezza indica la sporgenza posteriore della rete ad altezza traversa, la seconda grandezza indica quella a terra**

**Depth: the first figure indicates the rear depth of the net at crossbar level, the second figure indicates the rear depth at ground**

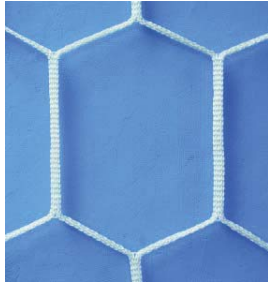

**Art. 133**  
**Coppia Reti**  
**m. 4x2**  
in polipropilene  
mm. 4  
profondità  
cm.120x120  
Pair of nets 4x2 m.  
Polipropilene  
mm. 4 thickness  
cm.120x120 depth

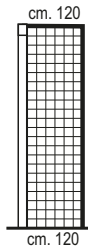

**Art. 133SN**  
**Coppia Reti m. 4x2**  
annodate in  
polietilene mm. 2,5  
profondità  
cm.100x100  
Pair of knotted nets  
4x2 m.  
polietilene thickness  
2,5 mm.  
cm.100x100 depth

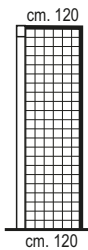
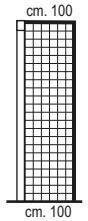

**Art. 133LR**  
**Coppia Reti m. 4x2**  
annodate in polietilene  
spessore mm. 3,5  
profondità cm.120x120  
Pair of knotted nets  
4x2 m. polietilene  
thickness 3,5 mm.  
cm.120x120 depth



**Art. 133NP**  
**Coppia Reti m. 4x2**  
annodate in polietilene  
spessore mm. 3,5  
profondità cm.100x160  
Pair of knotted nets  
4x2 m. polietilene  
thickness 3,5 mm.  
cm.100x160 depth

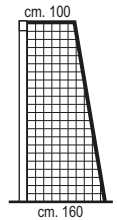

**Art. 132N**  
**Coppia Reti m. 5x2**  
annodate in polietilene mm. 2,5  
profondità cm.120x120  
Pair of knotted nets  
5x2 m. polietilene  
thickness 2,5 mm.  
cm.120x120 depth

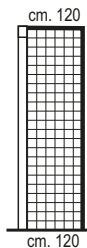

pg.27

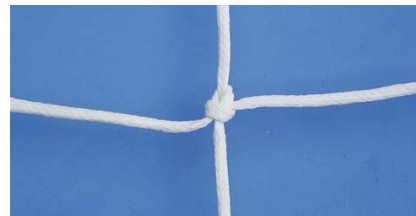

**Art. B171**  
**Coppia Reti m. 5x2**  
annodate in polietilene mm. 3,5  
profondità cm.100x160  
Pair of knotted nets  
5x2 m. polietilene  
thickness 3,5 mm.  
cm.100x160 depth

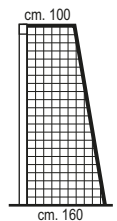

**Art. 131N**  
**Coppia Reti m. 6x2**  
annodate in polietilene mm. 2,5  
profondità cm.120x120  
Pair of knotted nets  
6x2 m. polietilene  
thickness 2,5 mm.  
cm.120x120 depth

**Art. B170**  
**Coppia Reti m. 6x2**  
annodate in polietilene mm. 3,5  
profondità cm.100x160  
Pair of knotted nets  
6x2 m. polietilene  
thickness 3,5 mm.  
cm.100x160 depth

**Art. 131.22**  
**Coppia Reti**  
**m. 6x2,2**  
annodate in  
polietilene  
mm. 3,5  
profondità  
cm.100x160  
Pair of knotted nets  
6x2,20 m.  
polietilene  
thickness 3,5 mm.  
cm.100x160 depth

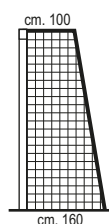
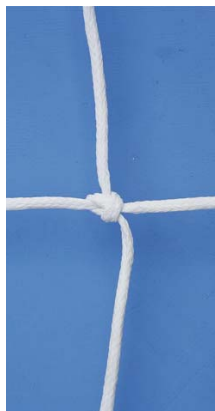

**Art. 131.5**  
**Coppia Reti**  
**m. 6,50x2,50**  
in polipropilene  
mm. 4  
profondità  
cm.120x120  
Pair of nets  
6,50x2,50 m.  
Polipropilene  
mm. 4 thickness  
cm.120x120 depth

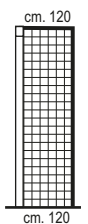
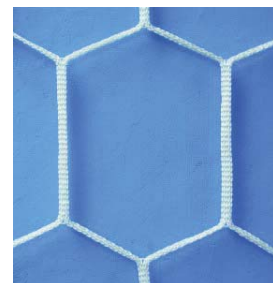

**RETI CALCETTO - Futsal Nets m. 3x2**

**Profondità cm.100x100**  
Depth: 100x100 cm.

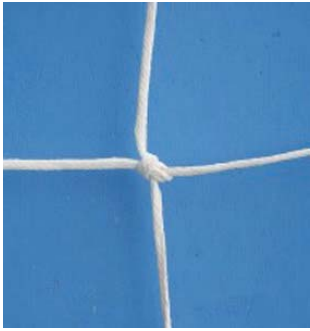

**Art. 134E**  
Coppia reti m.3x2 annodate in polietilene spessore mm.2,5  
Pair of 3x2 meter nets knotted polietilene thickness 2,5 mm.

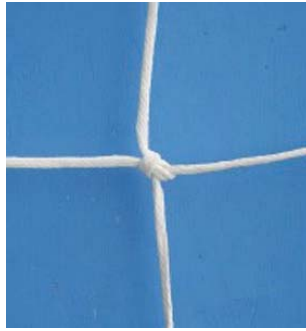

**Art. 135C**  
Coppia reti m.3x2 annodate in polietilene spessore mm.3,5  
Pair of 3x2 meter nets knotted polietilene thickness 3,5 mm.

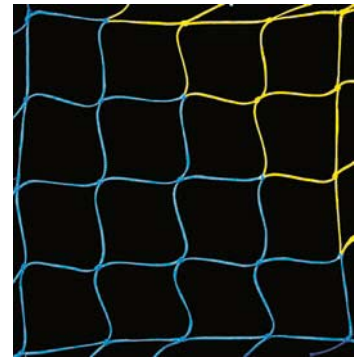
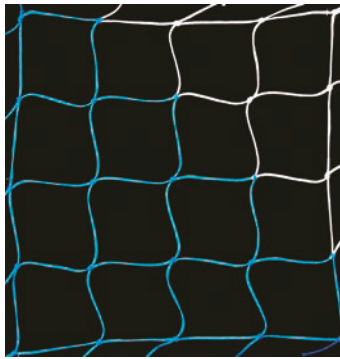
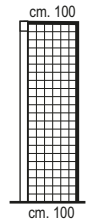

**Art. 135FR** Coppia reti m.3x2 annodate in polietilene spessore mm.3 colori: bianco-royal, bianco-rosso, giallo-royal  
Pair of 3x2 meter nets knotted polietilene thickness 3 mm. colors: royal/white, red/white, yellow/royal

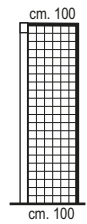
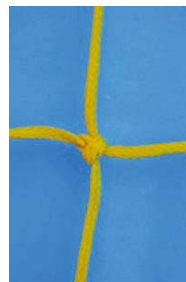
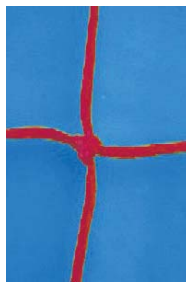

**Art. 135** Coppia reti m.3x2 annodate in polietilene spessore mm.4,5 colori: rosso, bianco, giallo  
Pair of 3x2 meter nets knotted polietilene thickness 4,5 mm. Colors: red, yellow or white

pg.27



**Art. 137**  
Coppia reti **m.1,5x1,1** per Miniporte  
Pair of nets 1,5x1,1 m. for Mini-goals

**RETI PORTAPALLONI - Ball sacs**



**Art. 041-6 / 041-12 / 041-18**  
Reti Portapalloni in polipropilene senza nodo (da 6, 12 o 18 palloni)  
Nets for balls in polypropylene (for 6, 12 or 18 balls)



**S041-6 / S041-12 / S041-18**  
Reti Portapalloni in polipropilene con nodo (da 6, 12 o 18 palloni)  
Knotted Nets for balls in polypropylene (for 6, 12 or 18 balls)

pg.28

**Art. SM20**  
Sacca Portapalloni in nylon 420/PVC  
capienza 20 palloni  
Ball Sac for 20 balls



## RETI DI PROTEZIONE - Protection nets



**TUTTE LE RETI DI PROTEZIONE VENGONO REALIZZATE SU MISURA IN BASE ALLE RICHIESTE DEL CLIENTE IN CIRCA 10 GIORNI**

All protection nets are manufactured according to Customer's needs in about 10 days

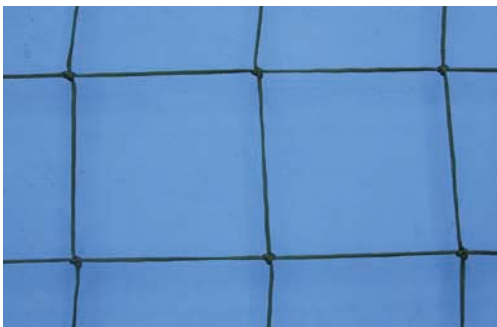

● pg.28

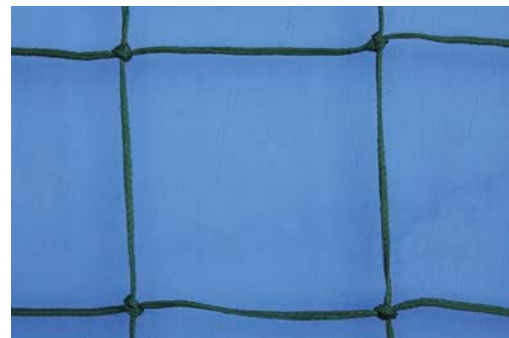

**Art. 093N**  
**Rete protezione polietilene verde annodata maglia cm. 13x13 sp. mm.2,5 (per calcio e calcetto)**  
Protection Net green polyethylene mesh 13x13 cm. knotted, thickness 2,5 mm.

**Art. 093.5**  
**Rete protezione polietilene verde annodata maglia cm. 13x13 sp. mm.3,5 (per calcio e calcetto)**  
Protection Net green polyethylene mesh 13x13 cm. knotted, thickness 3,5 mm.



**Art. 0934N**  
**Rete protezione polietilene verde annodata maglia mm. 45x45 sp. mm.2 (per tennis e baseball)**  
Protection Net green polyethylene mesh 4,5x4,5 cm. knotted, thick 2 mm. (for tennis and baseball)

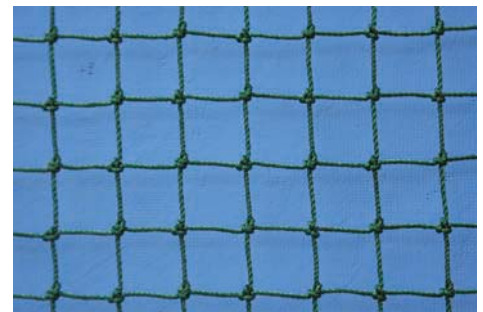

**Art. R55**  
**Rete protezione polietilene nera maglia mm.18 annodata sp. mm.2 antioggetto / antipetardo**  
Protection Net anti-objects and fire crackers

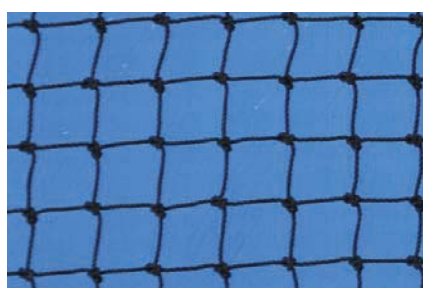

**Art. R57**  
**Rete protezione polietilene verde maglia mm.25x25 sp. mm.3 (per golf)**  
Protection Net for golf

## RETI PER CALCI DI PRECISIONE - Precision shooting nets

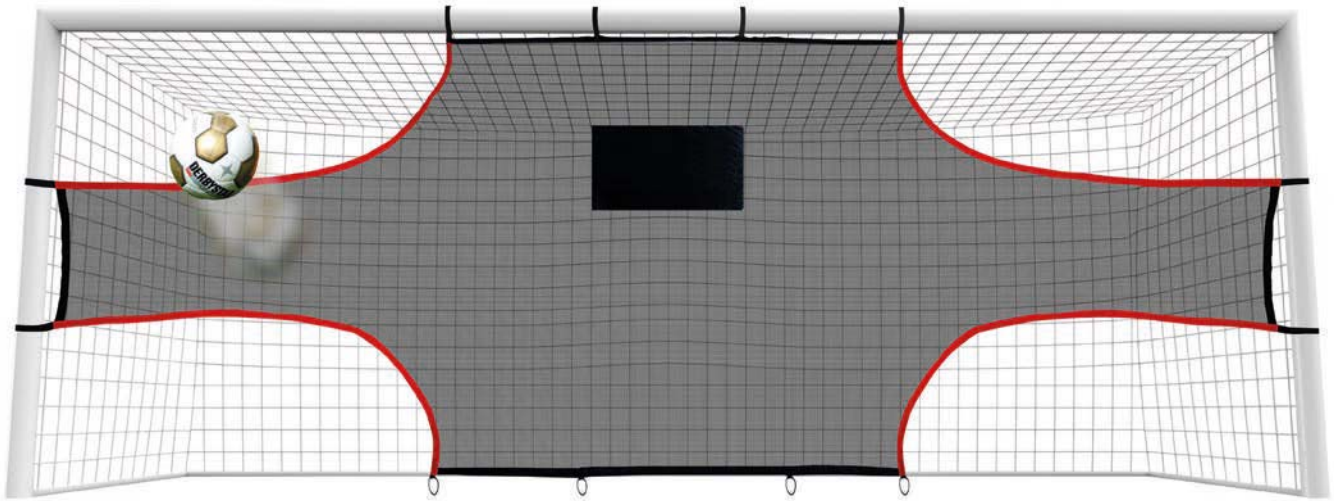

**Art. PTI.732**

**Rete bersaglio per porta regolamentare completa di fasce con velcro per fissaggio a pali e traversa e picchetti per ancoraggio a terra**

pg.28

Target net for regular size goal complete with velcro straps for fixing to poles and crossbar and pegs for ground anchoring

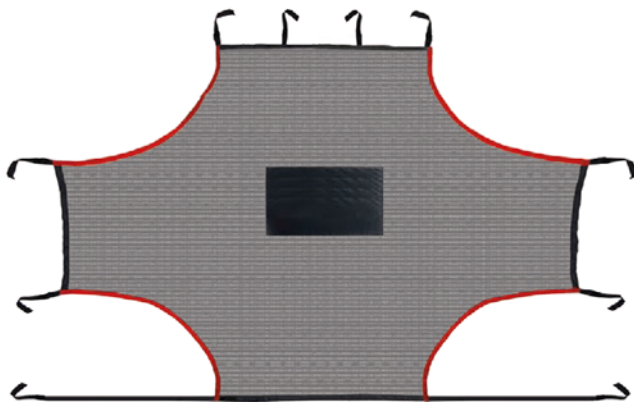

pg.28

**Art. PTI.275**

**Rete bersaglio per porta m.3x2 completa di fasce con velcro per fissaggio a pali e traversa e picchetti per ancoraggio a terra**

Target net for futsal goal complete with velcro straps for fixing to poles and crossbar and pegs for ground anchoring

pg.28

**4 tasche bersaglio per calci di estrema precisione**



**4 target pockets for very accurate shootings**

*Basta raccogliere palloni in fondo al sacco, lascia che sia la palla a tornare da te!*

*Stop picking up balls all the time, let the ball come back to you!*

**Art. GM**

**Rete respingente con 4 tasche per calci di precisione completa di corda elastica e picchetti da applicare a porta regolamentare**  
Special net with 4 accuracy pockets including elastic rope and pegs for regular size goal

**Art. GM42**

**Rete respingente con 4 tasche per calci di precisione completa di corda elastica e picchetti da applicare a porta m. 4x2**  
Special net with 4 accuracy pockets including elastic rope and pegs for m. 4x2 goal





pg.28

**ART. 05020785**

**Set bande elastiche per allenamento ai tiri di precisione - completo di borsa impermeabile composto da 3 strisce orizzontali + 3 verticali + 2 strisce bianche per utilizzo su superfici sintetiche + 3 sacchi per sabbia (da riempire) + accessori per il fissaggio - da applicare a porta regolamentare**

Straps for flexible marking of target zones for official size goal

Set of 3 horizontal bands + 3 vertical bands

+ 2 bands (white) for indoor use, on artificial turf etc. + 3 sandbags (without sand) + fixing accessories  
Packed in a waterproof bag

**New!**

pg.7

**Art. QBFG**  
**CROSS TRAINING**  
rete bersaglio  
sempre in piedi per  
allenamento alla  
precisione del cross,  
del lancio in  
profondità,  
del rinvio del portiere  
**CROSS TRAINING**  
movable target to  
improve crossing, long  
passing and GK kicks  
precision

**Il bersaglio ha dimensioni cm.120x120,**  
**ha una inclinazione regolabile da**  
**orizzontale a quasi verticale ed è in grado**  
**di ricevere la palla ad altezze comprese**  
**tra cm.175 e cm.262**  
**senza mai cadere a terra**  
**base in alluminio, peso Kg.10**  
**facilmente spostabile sul campo**

The basket is adjustable from horizontal to nearly vertical, height adjustable from 175 to 262 cm. - aluminium base, weight 10 Kg. very easy to move on the field, never falls down when hit by the ball



## PANCHINE ALLENATORI - Trainers' dug-outs



Panchina allenatori  
profilo curvato  
mm. 50x30 in acciaio  
zincato a caldo  
**Art. V6230 e seguenti**  
rivestimento  
posteriore e laterale  
in policarbonato  
alveolare non  
trasparente spessore  
mm. 4,  
piano di seduta con  
scocche in  
polipropilene montate  
su telaio zincato

Altezza tettuccio cm. 200, profondità fianco laterale cm. 88

● pg.29

Panchina allenatori  
profilo curvato  
mm. 50x30 in acciaio  
zincato a caldo  
**Art. V6220**  
**e seguenti**  
rivestimento  
posteriore e laterale in  
policarbonato  
trasparente spessore  
mm. 3, piano di seduta  
con scocche in  
polipropilene montate  
su telaio zincato



**Art. V6285**  
Protezione in poliuretano espanso  
per bordo panchina allenatori  
con profilo mm. 50x30

**Art. V6288**  
Coppia ruote da applicare a  
panchina con profilo  
mm. 50x30 al fine  
di renderla trasportabile





**Art. 155AV/156AV/157AV/158AV/159AV/159.7AV/159.8AV/155AV4**

**Panchina allenatori con struttura in tubo quadro in lega d'alluminio mm. 30x30 con copertura in policarbonato alveolare non trasparente - fianchi laterali in policarbonato trasparente (2 scocche di seduta in polipropilene per ogni metro di lunghezza)**  
Dug-out in light alloy square pipe mm. 30x30 with non transparent alveolar protection  
Transparent protection on both sides (2 polypropylene seats per every meter of length)

● pg.30

*È possibile sostituire le scocche con le panche a listoni in legno con schienale senza variazioni di prezzo*  
*Available wooden benches with back in spite of seats, at the same price*



*È necessario fissare le panchine su una base in cemento tramite tasselli: la base dovrà essere più estesa di circa 30 cm. per ciascun lato rispetto alla lunghezza e alla profondità della panchina.*  
*It is necessary to anchor dug-outs upon concrete base. Size of concrete base must be about 60 cm. longer and deeper than dug-out perimeter size (30 cm. longer and wider on each of the 4 sides)*



Altezza tettuccio cm. 200 profondità fianco laterale cm. 74  
Roof height 200 cm. - side depth 74 cm.



**Art. 155/156/157/158/159/159.7/159.8/155-4**

**Panchina con struttura in tubo quadro in lega d'alluminio mm. 30x30 con copertura in policarbonato trasparente e scocche di seduta in polipropilene (2 scocche di seduta per ogni metro di lunghezza)**

Dug-out in light alloy square pipe mm. 30x30 with transparent polycarbonate protection (2 polypropylene seats per every meter of length) pg.29 pg.30

*La verniciatura con colore a richiesta del tubo quadro in alluminio comporta una maggiorazione del prezzo del 10%*  
*Optional painting of the square pipe frame in aluminium (color on request): 10% additional charge on selling price*

*È possibile sostituire le scocche con le panche a listoni in legno con schienale senza variazioni di prezzo*  
*Available wooden benches with back in spite of seats, at the same price*

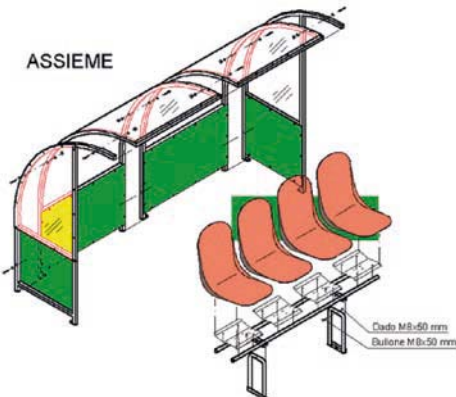

**Art. ASBI**  
**Seduta ricambio per panchina allenatori colore rosso o blu, fissaggio con 4 viti**  
Spare Seat for Dug-Outs in red or blue color, fixing with 4 screws

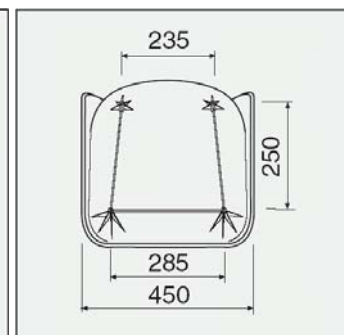
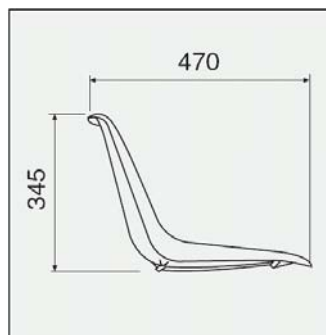

*È necessario fissare le panchine su una base in cemento tramite tasselli: la base dovrà essere più estesa di circa 30 cm. per ciascun lato rispetto alla lunghezza e alla profondità della panchina*  
*It is necessary to anchor dug-outs upon concrete base. Size of concrete base must be about 60 cm. longer and deeper than dug-out perimeter size (30 cm. longer and wider on each of the 4 sides)*

## PANCHINE ALLENATORI IDEALI PER CAMPI CALCETTO Trainers' dug-outs for futsal pitches



Panchina allenatori profilo curvato  
mm 40x20 in lega di alluminio  
rivestimento posteriore e laterale  
in policarbonato alveolare sp. mm. 4  
profondità a terra cm. 97,  
altezza massima cm. 208  
lunghezza metri 2 oppure metri 3  
con panca sedute  
in acciaio zincato e legno  
**Art. V6242.2 e Art. V6242.3**  
o con panca sedute  
in alluminio anodizzato  
**Art. V6241.2 e Art. V6241.3**

● pg.31



Dug-out curved profile  
40x20 mm. in light alloy  
rear and side coverings  
in non transparent polycarbonate  
4 mm. thick  
soil depth 97 cm.  
maximum height 208 cm.  
2 meters or 3 meters length  
with wooden bench on  
galvanized steel  
**Art V6242.2 and V6242.3**  
or with bench in  
anodized aluminium  
**Art V6241.2 and V6241.3**

## PANCHINE ALLENATORI IDEALI PER CAMPI CALCETTO Trainers' dug-outs for futsal pitches



Panchina allenatori trasportabile su ruote, profilo curvato mm. 50x30 in lega di alluminio rivestimento posteriore e laterale in policarbonato alveolare sp. mm. 4 **Art. V6291** oppure in policarbonato trasparente sp. mm. 3 **Art. V6292** profondità a terra cm. 150, altezza utile cm. 210 lunghezza metri 3 con supporto sedute in acciaio zincato e 6 scocche in polipropilene con piano borse sul retro dei seggiolini

pg.31

Dug-out transportable on wheels curved profile 50x30 mm. in light alloy rear and side coverings in non transparent polycarbonate mm. 4 thick **Art V6291** or in transparent polycarbonate mm. 3 thick **Art V6292** depth on the ground 150 cm. useful height 210 cm. length 3 meters with galvanized steel seat support and 6 polypropylene seats with back space for bags



**Art. S04910**  
Panchina bordo campo struttura in acciaio zincato lunghezza cm. 200 con 4 scocche di seduta in polipropilene colorato  
4 Sideline seats on galvanized steel frame length 200 cm.

pg.42



**Art. 155FZ2/155FZ4/155FZ6/155FZ8**

**Panchina allenatori in acciaio zincato a caldo rinforzato profilo mm. 40x40 con profondità cm.180 (misurando da tettuccio a limite base posteriore di appoggio) rivestita con lastre in policarbonato trasparente spessore mm. 3 piano di seduta con scocche in polipropilene**

Dug-Out in galvanized steel pipe 40x40 mm. - 180 cm. depth (from back protection to edge of roof)  
transparent polycarbonate 3 mm. thick back cover - polypropylene seats on steel frame (2 seats each meter)



● pg.30

**Art. 155PR**

**Rivestimento di protezione in schiumato per tettuccio e montanti**  
Soft edge protections



**Art. LXR2/LXR4/LXR6/LXR8**

**Panchina allenatori in tubo di acciaio zincato a caldo profilo mm. 40x40 TRASPORTABILE su ruote - copertura in policarbonato trasparente profondità cm. 135 piano di seduta con scocche in polipropilene**

Dug-Out in galvanized steel pipe 40x40 mm. - TRANSPORTABLE on wheels  
transparent polycarbonate back cover, polypropylene seats

## PANCHINE LUSO CON SEDUTE IN ECOPELLE - Leather seat dug-outs

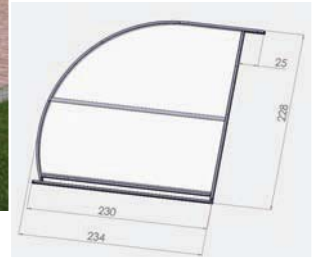

**PREVENTIVO SU RICHIESTA  
PRICES ON REQUEST**

**Modelli fissi o trasportabili  
struttura in acciaio zincato  
poltrone in ecopelle personalizzabili**  
Fixed or transportable Dug-Outs  
galvanized steel frame  
customizable leather seats

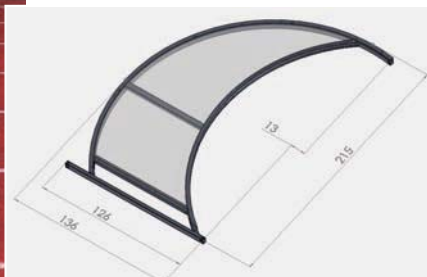



## CARRELLI TRACCIALINEE - Line markers

pg.28



**Per una resa ottimale e per evitare inconvenienti utilizzare sempre carbonato di calcio asciutto, ovvero la comune polvere di marmo**

**For optimal performance always use dry calcium carbonate, that is the common marble dust**

**Art. 142S**  
**Carrello traccialinee a polvere**  
Marble Powder Line Marker

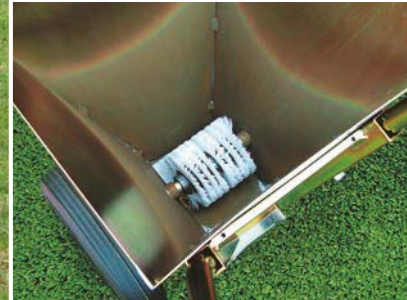

**UTILIZZARE SOLTANTO VERNICE ECOLOGICA ATOSSICA E PULIRE DOPO OGNI USO IL SERBATOIO E TUTTO IL CIRCUITO DI SPRUZZO FINO AGLI UGELLI (occorre spruzzare ripetutamente acqua prima di riporre l'attrezzo)**  
Always use ecological paint and wash with water after use (put water in the tank and spray)



**Art. 144**  
**Carrello traccialinee a vernice ecologica con serbatoio munito di pompante a pressione manuale**  
Paint Line Marker with manual pressure tank

pg.28



Particolare  
leva pressione  
spruzzo

**Art. 145**  
**Carrello traccialinee a vernice ecologica con motore a scoppio a miscela serbatoio vernice lt.25 tracciatura laterale regolabile**  
Paint Line Marker with 2 stroke engine 25 liter tank



**Art. 144.EL**

**Carrello traccialinee a vernice elettrico completo di caricabatteria (per la batteria della pompa elettrica) capacità serbatoio litri 18 tracciatura laterale regolabile**  
Electric Line Marker complete with battery charger 18 liter tank adjustable lateral marking device

● pg.28

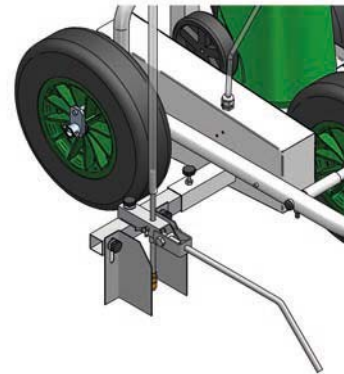

**Art. F211**

**Mirino in acciaio zincato per carrelli traccialinee Art. 144.EL ed Art. 145**  
Foresight in galvanized steel for line markers Art. 144.EL and Art. 145

● pg.28

**Art. 144.SL**

**Carrello traccialinee a rulli senza serbatoio a pressione né motore a scoppio. Tramite la rotazione dei rulli, la vernice viene prelevata all'interno del serbatoio e spalmata sull'erba.**

Roller Paint Line Marker  
Just fill up the tank with paint and push the machine.

Taking advantage of rolling wheels, paint flows from tank down to grass the easiest way!





**Art. 146**

**Vernice Ecologica atossica per manti erbosi Linea Stadio**  
 lt. 15 - Kg. 19 ad alto rendimento  
 Ecological Paint for grass 15 liters - 19 Kg.

pg.28



**Art. 146E**

**Vernice Ecologica atossica per manti erbosi Biancostadio** lt. 17 - Kg. 19  
 Ecological Paint for grass 17 liters - 19 Kg.

pg.29



**Art. NTESA**

**Rotolo Nastro adesivo mt. 50 - larghezza cm. 5 vari colori per tracciatura righe su superfici sintetiche**  
 Tape for bounds 50 meter - 5 cm. width

**Art. 146BP/146BPG**

**Vernice bianca o gialla per manti sintetici a bassa permanenza (1 settimana) 17 litri**  
 Paint for artificial grass white or yellow color, short durability (1 week) 17 liters



**Art. 146LP/146LPG**

**Vernice bianca o gialla per manti sintetici a lunga permanenza (3 mesi) 17 litri, da utilizzare solo con carrello a rulli**  
 Paint for artificial grass white or yellow color, long durability (3 months) 17 liters



**Art. SIFS**

**Fettuccia segnasettore in materiale sintetico impermeabile colore bianco o rosso larghezza mm. 50 in rotoli da mt. 25 (chiodi inclusi)**  
 Sector line in waterproof synthetic fabric, width 50 mm. length 25 m. color white or red (pegs included)



**Art. ELP2/ELP4**

**Elasticone per divisione spazi larghezza cm. 2 oppure cm. 4 lunghezza mt. 20, completo di 2 moschettoni**  
 Elastic bound 2 cm. width or 4 cm. width - length 20 meters - with 2 hooks



**Art. NS200**

**Rotolo nastro stradale mt. 200 - bianco/rosso**  
 Red/White Tape length 200 meters



**Art. PFIx Plifix**

**Picchetto di riferimento permanente con erba sintetica bianca o colorata, per agevolare la tracciatura delle righe dei campi di gioco o per delimitazione aree**  
**Confezione da 25 pezzi** **incluso**  
 Plifix - permanent peg with artificial white or coloured grass to help tracing lines on the field or mark areas 25 pieces set includes also plastic planting device



## SEDUTE PER GRADINATE - Stadium seats

**COLORI DISPONIBILI: blu, rosso, giallo, verde, bianco, nero, grigio**  
**AVAILABLE COLORS: blue, red, yellow, green, white, black, grey**

**ORDINE MINIMO 10 PEZZI PER MODELLO E COLORE**  
 Minimum quantity 10 pieces per model and color

**ATTENZIONE:  
 NON PER PANCHINE  
 ALLENATORI!  
 NOT FOR TRAINERS'  
 DUG-OUTS!**



**Art. M2003/M2003A**

**Art. M2003** Seduta in polipropilene con schienale ignifuga e antiultravioletti (secondo normativa UEFA) fissaggio diretto sulla gradinata con tasselli (non inclusi)  
 Polypropylene Seat non ignitable and anti-ultraviolet rays with back rest (according to UEFA requirements) to be fixed with screws (not included)

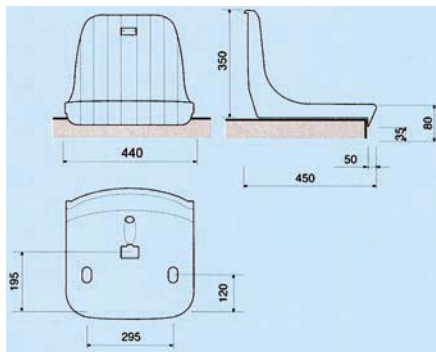

**Art. M2003A** Seduta in polipropilene con schienale come Art. M2003 solo antiultravioletti, fissaggio diretto sulla gradinata con tasselli (non inclusi)  
 Polypropylene Seat as Art. M2003 anti-ultraviolet rays, with back rest to be fixed with screws (not included)

pg.31

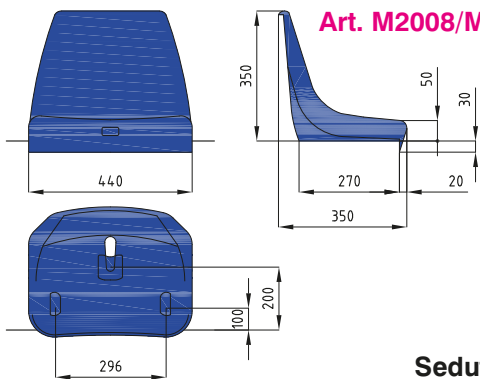

**Art. M2008/M2008A**



**Seduta in polipropilene con schienale ignifuga e antiultravioletti Art. M2008 oppure solo antiultravioletti Art. M2008A - fissaggio diretto sulla gradinata con tasselli (non inclusi)**  
 Polypropylene Seat non ignitable and anti-ultraviolet rays **Art. M2008** or only anti-ultraviolet rays **Art. M2008A** with back rest to be fixed with screws (not included)

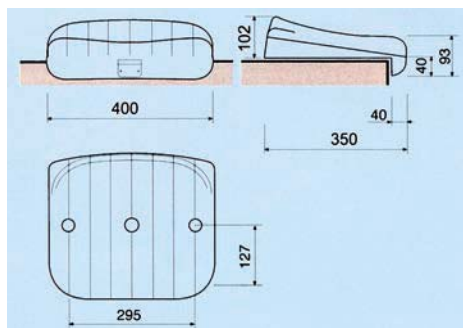
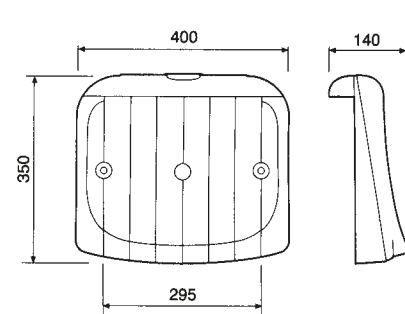

**Art. M90**

**Seduta in polipropilene senza schienale ignifuga e antiultravioletti fissaggio diretto sulla gradinata con tasselli (non inclusi)**

Polypropylene Seat non ignitable and anti-ultraviolet rays, without back rest - to be fixed with screws (not included)

**Art. M90.A**

**Seduta in polipropilene senza schienale come Art. M90 solo antiultravioletti fissaggio diretto sulla gradinata con tasselli (non inclusi)**

Polypropylene Seat as Art. M90 anti-ultraviolet rays, without back rest - to be fixed with screws (not included)

pg.31



**Art. M90/M90.A**

## TRIBUNE - Stands



### Art. G12005

**Modulo Tribuna per interno/esterno su 3 file in acciaio zincato trasportabile su ruote, piani di seduta in carply, lunghezza m. 2,5**  
Indoor/outdoor Stand in galvanized steel, 3 rows, movable on wheels, with wooden benches



pg.32



### Art. G12006

**Modulo Tribuna per interno/esterno su 3 file in acciaio zincato trasportabile su ruote, piani di seduta con scocche in polipropilene, lunghezza m. 2,5**  
Indoor/outdoor Stand in galvanized steel, 3 rows, movable on wheels, with polypropylene seats



**Art. G120TM**  
**Tribuna telescopica da interno  
con sedute in polipropilene**  
Telescopic Stand for indoor  
with polypropylene seats

pg.32



pg.31

**Art. CTMB1**  
**Cuscino per tribuna pieghevole  
rivestito in nylon**  
colori blu o rosso, bordo nero  
(ordine minimo 30 pezzi per colore)  
Foldable seat Cover - color blue or red  
(minimum quantity 30 pieces per color)



**Art. S07700**  
**Transenna in  
acciaio zincato**  
cm. 200x100h.  
Galvanized steel barrier 200x100 cm.

pg.32



**Art. S07710**  
**Transenna in plastica cm. 215x90h. con piedi di appoggio  
a terra ruotabili, con banda catarifrangente e sistema di  
aggancio a catena**  
Plastic barrier 215x90 cm.

## ARREDI PER SPOGLIATOIO - Dressing Room Benches



**Art. S07326 / S07324**  
Tavola appendiabiti  
con grucce m.1 / m.2  
Clothes hanger board m.1 / m.2

**Art. S07322 / S07320**  
Tavola appendiabiti con tettuccio lunghezza m.1 / m.2  
Clothes hanger board with bag holder m.1 / m.2

**Art. S902.1E / S902.2E**  
Panca in acciaio verniciato  
con listoni in legno m.1 / m.2  
con schienale e appendiabiti  
Bench in painted steel and  
wood length m.1 / m.2  
with back rest and clothes hanger board



**Art. S07308 / S07306**  
Panca in acciaio verniciato  
con listoni in legno  
m.1 / m.2 con schienale  
Bench in painted steel and  
wood length m.1 / m.2  
with back rest

**Art. S07304 / S07302**  
Panca in acciaio verniciato  
con listoni in legno m.1 / m.2  
Bench in painted steel and  
wood length m.1 / m.2

pg.32



**Art. S07406 / S07404**  
Pedana poggiaiedi a listoni  
in legno lunghezza m.1 / m.2  
Footrest in wood, length m.1 / m.2

**Art. S07312 / S07310**  
Panca con schienale, appendiabiti e  
portaborse in acciaio verniciato  
con listoni in legno  
lunghezza m.1 / m.2  
Complete Bench  
in painted steel and  
wood length m.1 / m.2

Disponibile  
anche lunghezza  
m. 1,5  
(al prezzo della  
lunghezza m. 2)  
Also available  
length 1,5 m.  
(at the same price  
as length 2 m.)



**Art. S07314**  
Panca completa  
ad isola per centro  
locale m.2  
in acciaio verniciato  
con listoni in legno  
Double bench  
in painted steel and  
wood length m.2

Colore standard del telaio: rosso  
Per argento o giallo supplemento 5%  
Standard color of frame: red  
For silver or yellow 5% price increase



**Panca con schienale, appendiabiti e portaborse in alluminio anodizzato con inserti in PVC lunghezza m. 1 Art. V8626 oppure lunghezza m. 2 Art. V8627**  
 Complete Bench in anodized aluminium length m. 1 Art. V8626 or length m. 2 Art. V8627

pg.32 pg.33

**Pedana poggiapiedi in alluminio anodizzato lunghezza m. 1 Art. V9092 oppure lunghezza m. 2 Art. V9093**  
 Footrest in anodized aluminium length 1 or 2 meters

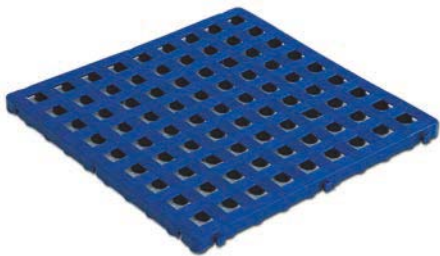

**Art. S07408**  
**Pedana poggiapiedi in plastica cm. 50x50**  
 Plastic footrest 50x50 cm.



**Art. S07434**  
**Graticcio per doccia in legno cm. 60x60**  
 Wooden footrest 60x60 cm.



**Art. S07466**  
**Asciugacapelli elettrico con temporizzatore e tubo flessibile**  
 Hair dryer with timer and flexible pipe



**Art. TPD Poggiapiedi Footsy idrorepellente**  
 Foldable foot rest waterproof



**Art. S07458**  
**Asciugamani elettrico con temporizzatore**  
 Hand dryer with timer

**ALTRI ARTICOLI SUL LISTINO PREZZI**

pg.33



**Art. S07462**  
**Asciugacapelli elettrico con temporizzatore**  
 Hair dryer with timer



## ARMADIETTI PER SPOGLIATOIO Dressing Room Lockers



**Art. S07226**  
Armadio spogliatoio  
a 15 posti in lamiera verniciata  
dimensioni totali  
overall dimensions  
cm. 103Lx35px180h



● pg.34

**Art. MAP30**  
Armadio portavalori a 30 sportelli  
dim. cm. 50hx95Lx20p con serrature  
Safe-deposit locker with 30 boxes

**Art. MAP50**  
Armadio portavalori a 50 sportelli  
dim. cm. 82hx95Lx20p con serrature  
Safe-deposit locker with 50 boxes



**Art. S07252 / S07254 / S07256**  
Armadio spogliatoio in laminato  
dim. vano cm.30Lx50px90h  
1 colonna 2 vani  
2 colonne 4 vani  
3 colonne 6 vani  
Laminated Lockers

**Art. S07258 / S07260 / S07262**  
Armadio spogliatoio in laminato  
dim. vano cm.30Lx50px180h  
1 colonna 1 vano  
2 colonne 2 vani  
3 colonne 3 vani  
Laminated Lockers

## ACCESSORI PER SPOGLIATOIO E INFERMERIA Dressing room and infirmary accessories



**Art. S07448**  
Specchio a parete  
con cornice in plastica  
diam.cm.60  
Wall mirror with frame  
diameter 60 cm.

**Art. S07438**  
Distributore di sapone  
liquido a parete  
Wall soap dispenser



**Art. S07442**  
Distributore di salviette a parete  
Wall towel dispenser



ALTRI ARTICOLI SUL  
LISTINO PREZZI



**Art. S07412**  
Tavolo per  
spogliatoio e  
locale arbitri  
cm. 80x80x76  
Locker room  
table  
80x80x76 cm.

pg.33



**Art. S07416** Bacheca  
con struttura in alluminio cm. 120x90  
Bulletin Board 120x90 cm.

**Art. S07414**  
Sedia in acciaio cromato  
scocca in polipropilene  
Chromed steel chair  
with polypropylene seat



**Art. S07418**  
Portaombrelli a 24 posti  
in acciaio verniciato  
Steel umbrella stand



**Art. S07715** Spazzolone  
per pulizia e asciugatura  
area pubblica e campo di gioco  
Scrubber for cleaning playcourt



**Art. S07102 / S07104**  
**Armadio a vetri a una o due ante**  
 Glass Cabinet with one or two doors



**Art. S07106** **Paravento a tre ante**  
**struttura in acciaio cromato**  
 Three shutter foldable screen



**Art. S07138**  
**Cassetta medica secondo D.M. 388**  
 First aid kit

pg.33

pg.34

ALTRI ARTICOLI SUL  
 LISTINO PREZZI



**Art. S07128**  
**Scaletta scendiletto**  
**in acciaio cromato**  
 Bedside step



**Art. S07124**  
**Sgabello girevole**  
**in alluminio**  
 Turnable stool



**Art. S07108**  
**Appendiabiti a colonna**  
**in acciaio cromato**  
 Clothes stand



**Art. S07132**  
**Cestino in plastica**  
 Plastic trashcan

**Art. S07130**  
**Portarifiuti**  
**a pedale**  
**in acciaio**  
**verniciato**  
 Metal trashcan



**Art. S07134**  
**Barella pieghevole**  
**in acciaio cromato**  
 Foldable Stretcher in  
 chromed steel





**Art. S07110**  
**Scrivania con cassettera**  
dim. cm.130x76x78  
Desk with 3 drawers dimensions 130x76x78 cm.

**Art. S07114**  
**Sedia imbottita, in acciaio cromato** Chair in chromed steel



**Art. S07410**  
**Tavolo per massaggi in acciaio imbottito in similpelle**  
Massage table

pg.33 pg.34

**Art. PBN**  
**Bilancia pesapersona con statimetro**  
Scales with height measurer



**Art. 3031S**  
**Lettino Antero chiudibile testiera regolabile**  
cm.180x60x73  
peso Kg.20  
colore nero  
in acciaio cromato  
Medical couch foldable in chromed steel

**Art. 3033S**  
**Borsone porta lettino Antero**  
Bag for Art. 3031S



**Art. PTI.BIL**  
**Bilancia pesapersona digitale con indicazione massa grassa**  
Digital scales body fat measurer



**Art. S07118**  
**Portarotolo**  
Paper roll holder

**Art. S07120**  
**Rotolo carta**  
Roll of paper

**Art. S07116**  
**Lettino visita medica imbottito con testiera reclinabile**  
Medical couch in chromed steel, padded, adjustable headrest

## TUNNEL USCITA SPOGLIATOI - Stadium tunnels



**Art. 160 Tunnel estensibile struttura in lega d'alluminio, copertura in PVC ignifugo Cl.2 bianco o colorato, montato su ruote in nylon, dimensioni standard (personalizzabili): larghezza cm.200, altezza al centro cm.232, altezza ai lati cm.200, in moduli da un metro**  
Extensible Tunnel in light alloy covered by fireproof PVC Cl.2, white or coloured, movable on nylon wheels - Standard dimensions 200 cm. width, 232 cm. height in the middle, 200 cm. height at the sides - made of one meter segments joined together



**Lunghezza, larghezza  
e altezza  
personalizzabili su richiesta**  
Any dimension available  
on request

## BEACH SOCCER



**Art. PBST** Coppia Porte Beach Soccer m. 5,5x2,2  
in lega d'alluminio, tubo sezione mm. 80  
verniciate in giallo con bussole  
Pair of Beach Soccer goals in aluminium  
5,5x2,2 m. - pipe 80 mm.  
painted yellow with sockets

pg.26

**Art. 110BS**  
Coppia Porte Beach Soccer m. 5,5x2,2  
in lega d'alluminio  
tubo sezione mm. 120x100  
verniciate in giallo con bussole  
(senza innesti da cementare)  
Pair of Beach Soccer goals in aluminium  
5,5x2,2 m. - pipe 120x100 mm.  
painted yellow with sockets



**Art. 073BS**  
Kit 10 paletti  
completi  
per Beach Soccer  
(6 bandierine rosse  
e 4 bandierine gialle)  
Beach Soccer  
Kit of 10 Poles  
(6 red flags and 4 yellow flags)

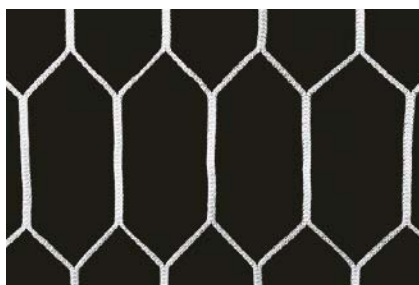

**Art. RBS** Coppia reti  
per porte Beach Soccer  
m. 5,5x2,2  
in polipropilene  
Pair of polypropylene  
nets for  
Beach Soccer goals  
5,5x2,2 m.



**Art. KDBS**  
Kit Delimitazione per campo Beach Soccer, colore  
blu: 2 nastri m. 28 + 2 nastri m. 37 larghezza mm. 80  
+ 8 picchetti e 8 elastici  
Kit for Beach Soccer bounds



**Art. ULT45**  
Pallone Beach  
Soccer Trial in gomma  
doppio strato  
(fino ad esaurimento scorte)  
Trial Beach Soccer Ball  
double stratum rubber  
(until available in stock)

## TAVOLI CALCETTO - Soccer tables



**Art. GA-F1**  
Tavolo calcetto  
in legno modello F1  
dim.cm.121x92x78h  
aste telescopiche  
ideale per bambini  
Soccer table model F1  
very good for children



**Art. JKBOM**  
Tavolo calcetto Bomber  
senza gettoniera  
aste telescopiche,  
piano in vetro temperato  
colore blu o bianco  
Soccer table Bomber

pg.44



**Art. IS432**  
Confezione 10 palline per  
tavolo calcetto  
10 Soccer table balls



### Art. FTGO.G

Tavolo calcetto modello Pride con  
gettoniera, aste cromate telescopiche,  
gambe in ferro verniciato, mobile in  
multistrato, peso kg. 73  
Soccer table model Pride with coin slot  
telescopic, legs in painted steel, weight 73 Kg.



Da esterno

**Art. G500**  
Tavolo calcetto da esterno  
G500 Weatherproof  
con aste telescopiche  
Soccer table G500 for outdoor



**Art. FTEC**  
Tavolo calcetto modello Pride  
con vetro protettivo  
ad alta resistenza, peso kg. 85  
Model Pride with high resistance safety  
glass, weight 85 Kg.

## BASKET



pg.34







**Art. S04056 / S04058**

**Impianto basket a muro fisso con sbalzo cm. 185 oppure cm. 325, tabelloni in bilaminato, canestri e retine**  
 Wall basketball system projection 185 or 325 cm. wooden boards, rings and nets



**Art. S04151**

**Impianto minibasket a muro fisso, sbalzo cm. 80, tabelloni in bilaminato canestri e retine**  
 Wall mini-basketball system projection 80 cm.



pg.34

**Art. S04152**

**Impianto minibasket a muro fisso, sbalzo cm. 185 tabelloni in bilaminato canestri e retine**  
 Wall mini-basketball system projection 185 cm.



**Art. S04150**

**Impianto basket/minibasket a muro regolabile in altezza con canestro e retina**  
 Wall basketball/mini-basketball system adjustable height



**Art. 0986**

**Impianto minibasket fisso a colonna zincato altezza regolabile tabelloni in resina canestri e retine**  
 altezza standard cm. 260 (su richiesta cm. 305)  
 Mini-basketball system galvanized steel posts, adjustable height, plastic boards, rings and nets standard height 260 cm. (305 cm. on request)

pg.35

**Art. S04161**

**Coppia strutture minibasket agganciabili a tabelloni basket complete di tabelloni in bilaminato, canestri e retine (attrezzo per sollevamento tabelloni Art. S04162 non incluso)**  
 Pair of mini-basketball constructions to be attached to basketball boards (rising tool Art. S04162 not included)



**Art. S04162**



**Art. 0987**  
**Impianto minibasket a colonna regolabile in altezza e trasportabile, fornito con canestri e retine**  
 Transportable mini-basket system

**Altezza massima cm. 260**  
 Maximum height 260 cm.

pg.35



**Art. S04012**  
**Struttura basket e minibasket richiudibile e trasportabile in acciaio verniciato, base porta zavorra, tabellone in resina, canestro fisso e retina, protezione frontale**  
 Transportable and foldable Basket/Minibasket in painted steel, resin board, front protection



**Art. 26760**  
**Tabellone minibasket in plastica da fissare al muro, fornito con canestro e retina**  
 Wall minibasket board



pg.34

**Art. 26759**  
**Basket a colonna regolabile in altezza da cm. 229 a cm. 305 trasportabile, con canestro e retina tabellone cm.120x70 rinforzato**  
 Basket adjustable height from 229 cm. to 305 cm. transportable



**Art. PPV01**  
**Protezione monotubolare singola in nylon idrorepellente con velcro cm. 180x9x2 per Art. 647B e Art. 26759**  
 Single monotubular soft protection for Art. 647B and Art. 26759



**Art. F126BSK**  
**Set Baskin trasportabile professional**  
 Transportable Baskin

**Art. 647B** Minibasket a colonna regolabile in altezza da cm. 168 a cm. 229 trasportabile, con canestro e retina tabellone cm. 90x60  
 Minibasket adjustable height from 168 cm. to 229 cm. transportable



**Art. F102**  
**Canestro Basket regolamentare**  
 (retina esclusa)  
 Basket standard



**Art. F103**  
**Canestro Basket rinforzato**  
 (retina esclusa)  
 Basket reinforced



**Art. F105**  
**Canestro Basket zincato**  
 (retina esclusa)  
 Basket galvanized



**Art. B030**  
**Coppia Retine in nylon**  
 mm. 3,5  
 Pair of nets 3,5 mm.



**Art. B050**  
**Coppia Retine in nylon**  
 mm. 6  
 Pair of nets 6 mm.



**Art. B060**  
**Coppia Retine in cotone**  
 mm. 7  
 Pair of nets 7 mm.



**Art. R122**  
**Coppia Retine in acciaio**  
 Pair of steel nets



**Art. F106**  
**Canestro Basket reclinabile, a norme FIBA**  
 (retina esclusa)  
 Reclining Basket



**Art. S04236**  
**Canestro Basket reclinabile, omologato a norme FIBA (retina esclusa)**  
 Approved reclining Basket

pg.35

**Art. NRG**  
**Set 12 ganci reggirete in plastica per canestro basket**  
 Set 12 plastic basket net holders

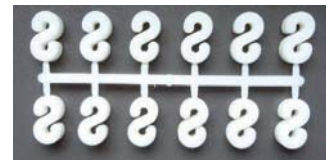

**Art. S04202 - S04214 - S04204 - F116/B - S04216**  
**Coppia tabelloni in bilaminato per interno oppure in resina melaminica per esterno - varie dimensioni**  
 Pair of basketball boards in chipboard for indoor or in resin for outdoor - various sizes

**Brevettato**  
**Patented**



**Art. F109**  
**Canestro Basket reclinabile frontalmente e lateralmente (retina esclusa)**  
 Front/Side reclining Basket

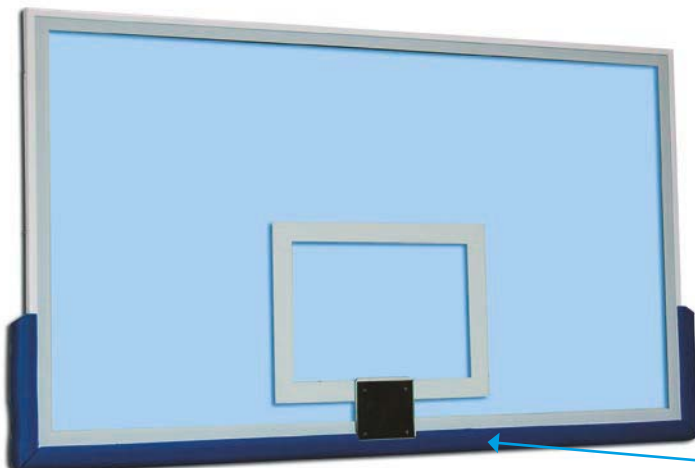

**Art. S04206 / S04208**  
**Coppia tabelloni in Plexiglass trasparente oppure cristallo temperato dimensioni cm. 180 x 105 - compreso telaio e protezione**  
 Pair of basketball boards in transparent acrylic or tempered glass 180 x 105 cm. mounted onto varnished steel frame with pads

**Art. B2063B / B2063**  
**Coppia Protezioni sottocanestro omologate FIBA e non**  
 Pair of soft board protection pads FIBA approved or not

pg.34

pg.35



**Art. S04254**  
**Panca per atleti e riserve con schienale m.3**  
 Bench length 3 meter with back rest

**Art. S04266**  
**Protezione mobile per tavolo giuria e atleti in policarbonato trasparente**  
 Transparent movable polycarbonate protection for benches and referees' table

● pg.35



**Art. ESB100** ● pg.45  
**Elemento di separazione e protezione bordo campo**  
 dim. cm. 120x40x100h.  
 in gommapiuma D30 rivestita in PVC con fondo antiscivolo e velcro  
 Foam rubber bound with PVC cover for floor delimitation size 120x40x100h. cm.



**Art. S04256**  
**Tavolo giuria**  
 cm. 160x80x76h.  
 Referee table



**Art. S04262**  
**Tavolo giuria cm. 300x70x76h. carenato su ruote**  
 Referee table on wheels



**Art. S04288**  
**Freccia indicatrice possesso palla**  
 Ball possession arrow



**Art. F255**  
**Freccia indicatrice elettronica possesso palla**  
 Electronic ball possession indicator



**Art. F254**  
**Segnalatore time out con impugnatura**  
 Time out indicator



**Art. CR016**  
**Cronometro contasecondi da tavolo a pila con display digitale**  
 Digital Table Clock for basketball



**Art. CR005**  
**Cronometro contasecondi da tavolo a pila con lancette**  
 Table Clock for basketball



**Art. S04280**  
Segnapunti  
manuale  
girevole  
a 6 cifre  
6 figure  
Scoreboard

pg.35



**Art. B01084**  
Segnapunti da tavolo per Basket  
Table scoreboard



**Art. S04274**  
Serie Palette 24"  
Set of 24 sec indicators



**Art. S04272**  
Serie palette per giudici  
Set of referee's foul indicators



**Art. S04282**  
Segnapunti manuale a parete a 6 cifre,  
struttura in acciaio verniciato  
Wall steel 6 figure scoreboard

pg.35

**Art. 089-B**  
Lavagna Basket  
cancellabile cm. 40x23  
Basket Tactical Board  
erasable 40x23 cm.



**Art. 087-B**  
Lavagna  
Basket  
magnetica  
cancellabile  
cm. 60x85  
Basket Tactical  
Board erasable  
and magnetic  
60x85 cm.

pg.36

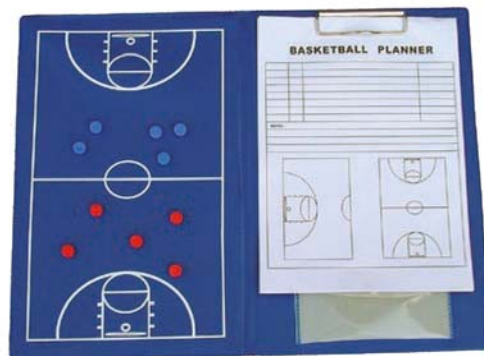

**Art. LSRK**  
Lavagna Basket magnetica cm. 40x23  
con block-notes (fino ad esaurimento)  
Basket Tactical Board  
magnetic 40x23 cm. with block-notes  
(until available)

**SKLZ** >>



**Art. SK.CVS  
COURT VISION**

Occhiali a visibilità limitata per allenamento al palleggio a testa alta, alla visione di gioco e alla reattività nei confronti dei difensori misura unica regolabile

Court vision dribble goggles force players to handle the ball with their head up to survey the court improve reaction time against defenders increase confidence on the court

**SKLZ** >>



**Art. SK.KOT  
KICK-OUT per ritorno palla dopo tiro a canestro - direzione regolabile**  
360° ball return system  
rotating chute returns made shots anywhere on the court  
easy twist adjustment with integrated handle



La fascia con le braccia gonfiate deve essere posizionata all'altezza delle spalle, e per installarla può essere necessario sgonfiare moderatamente la sagoma. Successivamente, dopo avere rigonfiato, se la sagoma torna in posizione verticale con difficoltà si deve aggiungere dell'acqua nel serbatoio

**Art. KBVS**  
Kit braccia verticali per sagoma gonfiabile cm. 205 Art. SAG205  
Raised arms kit for inflatable dummy 205 cm. Art. SAG205

**Specifico per il Basket, il kit si installa facilmente sulla sagoma (non inclusa) e rende possibile una moltitudine di esercizi tecnico-tattici**  
Designed for Basket training, this kit is easily installed on the dummy (not included) and makes lots of technical and tactical exercises possible

**SKLZ** >>

pg.36



**Art. SK.DMAN**  
Sagoma Basket D-MAN  
ad altezza regolabile da cm. 198 a cm. 243  
con basamento riempibile,  
munita di puntali per fissaggio anche su terreni naturali  
Hands-up defensive mannequin ideal for solo practice or team settings  
portable, lightweight adjustable telescoping pole (from 198 cm. to 243 cm.)  
Weighted base - including spikes for natural grass anchoring



**Art. MSBK4** Pallone avviamento al Minibasket Mondo gomma nylon misura 4  
Minibasket introduction ball



**Art. SB4Y** Pallone avviamento al Minibasket Molten gomma nylon misura 4  
Minibasket introduction ball



**Art. M13565** Pallone Street Basket Mondo 3x3 misura 6 (ad esaurimento)  
Mondo Street Basket ball 3 vs 3 - size 6



**Art. B3002** Pallone Basket e Minibasket gomma nylon misure 5-7  
Nylon rubber Basket and Minibasket ball



**Art. SBPRO5** Pallone Minibasket Mondo SB-PRO n. 5 gomma multistrato  
Multilayer rubber Minibasket Mondo SB-PRO 5 ball



**Art. B5G1600** Pallone Minibasket Molten B5G1600 gomma nylon (ex BGR5)  
Nylon rubber Minibasket Molten B5G1600 ball

pg.36



**Art. B7G1600/B6G1600** Pallone Basket Molten B7G1600/B6G1600 gomma nylon (ex BGR7/BGR6)  
Nylon rubber Basket Molten B7G1600/B6G1600 ball



**Art. B7G3800/B6G3800** Pallone Basket Molten B7G3800/B6G3800 pelle sintetica FIBA Approved (ex BGM7X/BGM6X)  
Leather Basket Molten B7G3800/B6G3800 ball

**Art. B7G4000/BGF6X** Pallone Basket Molten B7G4000/BGF6X pelle sintetica ufficiale FIP  
Leather Basket Molten B7G4000/BGF6X ball



**Art. B7G4500/B6G4500** Pallone Basket Molten B7G4500/B6G4500 pelle sintetica ufficiale FIP Lega Serie A (ex BGG7X/BGG6X)  
Leather Basket Molten B7G4500/B6G4500 ball



**Art. TRBB** Pallone reaction ball Trial rimbalzo e traiettorie imprevedibili per Basket  
Trial Reaction Ball unpredictable rebounds



**Art. BYCB** Pallone Basket bicolore gomma Trial Ø cm. 24 gr. 620  
Trial bicoloured rubber Basket ball



**Art. ULTS67** Pallone Basket gomma Trial allenamento potenziato Ø cm. 24 gr. 930 (+50%)  
Rubber Trial Heavier Basket ball



**Art. ULTD67** Pallone Basket gomma Trial allenamento potenziato Ø cm. 24 gr. 1240 (+100%)  
Rubber Trial Heavier Basket ball

## PALLAVOLO - Volleyball



**Art. 6746T**

**Art. 6746T**  
 Impianto pallavolo monotubolare in acciaio zincato Ø 76 mm. completo di bussole da interrare cm. 40 e tendirete, altezza della rete regolabile  
 Volleyball posts in galvanized steel with underground sockets adjustable height net

pg.37

pg.38



**Art. V5009**

**Art. V5009**  
 Impianto pallavolo monotubolare in alluminio T6 antiflessione mm. 120x100 con arganello tendirete autofrenante e senza cremagliera con manovella asportabile bussole e tappi in alluminio  
 Aluminium monotubular volleyball posts



**Art. ARGC**  
 Arganello a cremagliera con manovella per impianto pallavolo monotubolare  
 Spare rack winch for monotubular volleyball posts

Lato interno  
 Inner side



**Art. V5003**  
 Impianto pallavolo monotubolare in acciaio zincato Ø 70 mm. completo di bussole da interrare e tendirete, con sistema telescopico per la regolazione della rete con doppia carrucola sulla sommità del palo  
 Volleyball posts in galvanized steel with underground sockets telescopic posts adjustable height net

**Art. 6747/P**  
 Impianto pallavolo monotubolare a norme FIPAV in alluminio sezione mm. 120x100 regolazione dell'altezza dei pali e della rete con sistema periscopico con arganello tendirete e bussole incluse  
 Aluminium monotubular volleyball posts periscopic system FIPAV approved



**Art. 6747/P**

**Art. MB2083** Coppia Protezioni in gommapiuma rivestita per impianto monotubolare  
 Pair of soft protections for volleyball posts

**IMPIANTO = coppia pali (rete esclusa)**

**La regolazione periscopica permette di variare l'altezza dei pali insieme a quella della rete (che può essere regolata da cm. 215 a cm. 243)**





**Art. 1009**  
**Impianto pallavolo a traliccio in alluminio**  
 ø mm. 120x100 completo di ruote e tendirete  
 Volleyball posts in aluminium transportable with wheels, pipe section 120x100 mm.



**Art. MB2236**  
**Coppia protezioni in gommapiuma rivestita per impianto a traliccio**  
 Pair of soft protections for volleyball posts



Lato interno  
 Inner side



**Art. V5020**  
**Impianto pallavolo a traliccio ø mm. 70 in acciaio zincato completo di ruote e tendirete**  
 Volleyball posts in galvanized steel, transportable with wheels pipe section 70 mm.

**Art. 6740R**  
**Impianto pallavolo a traliccio ø mm. 70 in acciaio verniciato completo di tendirete e ruote**  
 Volleyball posts in painted steel pipe section 70 mm. with wheels



**Art. 6752/P**  
**Coppia protezioni per impianto Pallavolo a parete**  
 Pair of soft protections for volleyball posts for wall fixing

**Art. 6752/T**  
**Impianto Pallavolo a parete**  
 Volleyball posts for wall fixing

pg.38

**IMPIANTO = coppia pali (rete esclusa)**

**Art. V5029**  
**Impianto pallavolo a tiranti ridotti in lega di alluminio profilo sezione mm. 120x100 con ruote per il trasporto piastra antitorsione alla base, arganello tendirete autofrenante senza cremagliera antinfortunistico**  
 Volleyball posts in aluminium transportable with wheels, pipe section 120x100 mm.





**Art. E6532**  
**Rete pallavolo economica m. 9,85**  
 Cheap net for volleyball

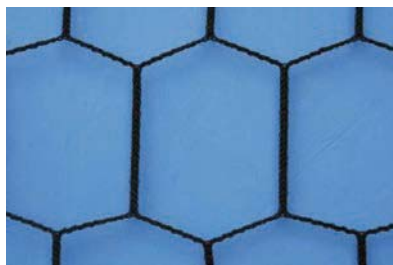

**Art. P030**  
**Rete pallavolo m. 9,50**  
 Net for volleyball

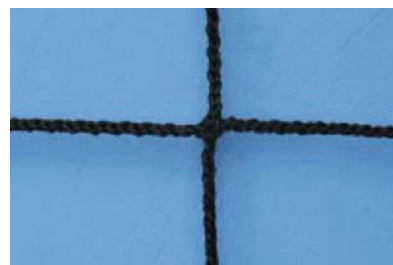

**Art. P100**  
**Rete pallavolo super pesante m. 9,50**  
**maglia mm. 100**  
 Heavy net for volleyball

pg.38



**Art. P110**  
**Rete pallavolo extra pesante**  
**m. 9,50 maglia mm. 100**  
**a doppia fascia**  
 Heavy net for volleyball double band



**Art. P200**  
**Rete pallavolo da gara**  
**maglia mm. 100**  
**con antenne e tasche**  
**a norma FIPAV**  
 Official net for volleyball  
 with sticks and fixing bands



**Art. P201**  
**Rete pallavolo da gara**  
**maglia mm. 45**  
**a norma FIPAV**  
**per campionati di Superlega**  
**(personalizzabile)**  
 Official net for volleyball  
 (customizable)



**Art. P14**  
**Coppia antenne in vetroresina divise**  
 Fiberglass sticks in 2 pieces

**Art. P15** Coppia  
 tasche porta  
 antenne cm. 5  
 Fixing bands for  
 sticks

**Art. P16**  
**Coppia antenne in**  
**vetroresina intere**  
 One piece fiberglass  
 sticks



**Art. S04814**  
**Segnapunti**  
**manuale**  
**girevole**  
**a 4 cifre**  
 4 figure  
 scoreboard



**Art. PP054**  
**Segnapunti manuale**  
**da tavolo per Pallavolo bifacciale**  
**(numeri da 0 a 50 non divisi)**  
 Volleyball table scoreboard



**Art. PPP30**  
**Segnapunti scolastico per Pallavolo**  
**numeri da 0 a 30 rinforzati**  
 Volleyball school scoreboard





**Art. 6768R**  
**Seggiolone arbitro pallavolo in piedi, in acciaio verniciato, mobile su ruote**  
 Referee's stand made of painted steel, on wheels

pg.38



**Art. S04804**  
**Seggiolone arbitro pallavolo ad altezza fissa con scocca di seduta, in acciaio verniciato, mobile su ruote**  
 Referee's stand fixed height with plastic seat, made of painted steel, on wheels



**Art. 1020**  
**Seggiolone arbitro pallavolo approvato FIPAV regolabile in altezza con scaletta di accesso e ruote per trasporto**  
 FIPAV Referee's chair



**Art. S04816**  
**Serie 18 Palette per sostituzione giocatori con contenitore**  
 Set of 18 substitution indicators

**Art. 089-V**  
**Lavagna per pallavolo cancellabile cm. 35x25**  
 Volleyball Tactical Board erasable 35x25 cm.





**Art. V5081**  
**Simulatore di muro su ruote in acciaio, zavorrato, con pannello a superficie irregolare**  
 Portable wall in painted steel with irregular surface board

pg.38

pg.39



**Art. V5082**  
**Simulatore di muro portatile per squadre femminili e giovanili**  
 Portable wall for women and kids



**Art. V5070**  
**Ball Catcher cm. 70x70 altezza regolabile da cm. 190 a cm. 320 con anello superiore inclinabile, basamento zavorrato e retone inclusi**  
 Ball catcher, adjustable height and inclination (weighted base and net included)

**Art. V5051**  
**Jump Tester in acciaio zincato telescopico regolabile da cm. 230 a cm. 380 (basamento zavorrato non incluso)**  
 Jump Tester in galvanized steel telescopic adjustable height from 230 to 380 cm. (weighted base not included)

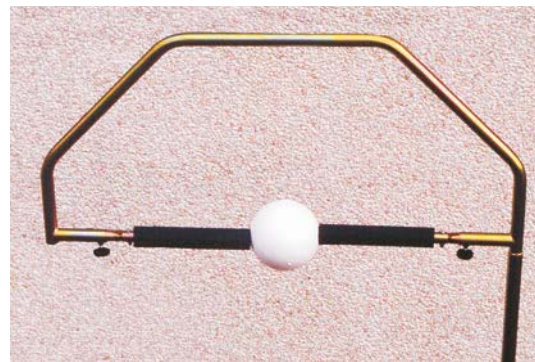

**Art. V5060** Spike con ganasce (basamento zavorrato non incluso)  
 (weighted base not included)

**Art. V5050**  
**Basamento zavorrato multiuso per Ball Catcher, Spike, Jump Tester**  
 Multi-purpose weighted base





Utilizzabile anche per Hit Ball



**Art. BV20**  
Pallone Volley Trial in gomma supersoft  
Supersoft Trial Volley ball  
(also for Hit Ball)

pg.39

**Art. V20**  
Pallone Volley Trial in gomma monostrato  
Single stratum Trial Volley ball

**Art. ULT20-3**  
Pallone Volley Trial in gomma triplo strato  
Triple stratum Trial Volley ball

**Art. MVBS**  
Pallone Volley School Mondo Under 13 peso ridotto  
Under 13 Mondo Volley School ball

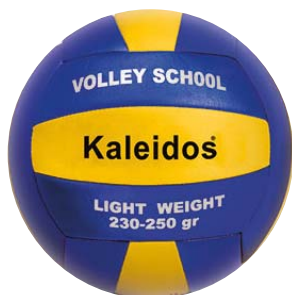

**Art. E6835**  
Pallone Volley Soft Touch in PU saldato, regolamentare  
Official size and weight Volley ball



**Art. 18335**  
Pallone Volley Molten V5M2501-L Under 13 peso ridotto (ex Volley School)  
Under 13 Molten Volley ball



**Art. 29096**  
Pallone Volley Molten Ultra Touch V5M1500 allenamento  
Molten Volley training ball



**Art. 6036**  
Pallone Volley Molten V5M4000  
Molten Volley ball



**Art. 6331**  
Pallone Volley gara Molten V5M5000 "FLISTATEC" FIVB Approved  
Molten Volley match ball

**Art. BYCV**  
Pallone Volley Trial gomma bicolore  
Trial bicoloured rubber Volley ball



**Art. TRBV**  
Pallone Reaction Ball Trial doppio strato per Volley rimbalzo e traiettorie imprevedibili  
Trial Volley ball for unpredictable rebounds

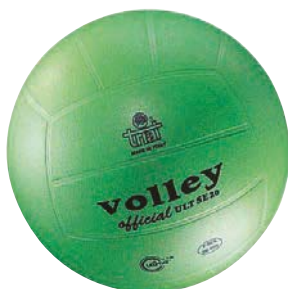

**Art. USE20**  
Pallone Volley Trial gr. 405 (+50%) ø cm. 21 per allenamento potenziato  
Rubber Trial heavier Volley ball

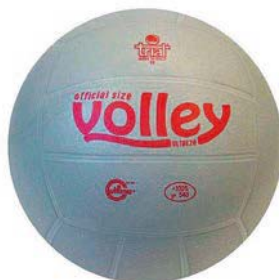

**Art. ULTD20**  
Pallone Volley Trial gr. 540 (+100%) ø cm. 21 per allenamento potenziato  
Rubber Trial heavier Volley ball

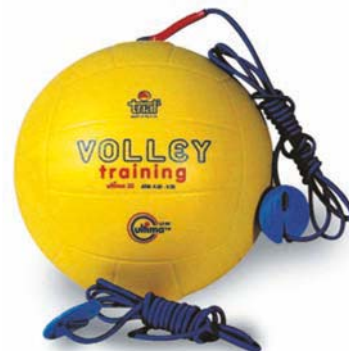

**Art. ULT22**  
Pallone Volley Trial training con 2 elastici  
Trial training Volley ball with 2 elastic ropes

## MINIVOLLEY - SUPERMINIVOLLEY



**Art. BV15**  
Pallone  
PRIMO VOLLEY  
Trial in gomma  
supersoft  
Trial supersoft  
Volley ball

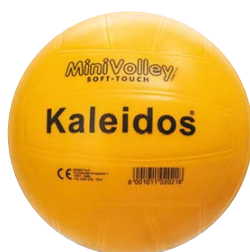

**Art. 191S**  
Pallone MINIVOLLEY  
in gomma Mondo  
Mondo rubber Minivolley ball



**Art. ULT15-3**  
Pallone PRIMO VOLLEY  
Trial in gomma triplo strato  
Trial triple stratum Volley ball

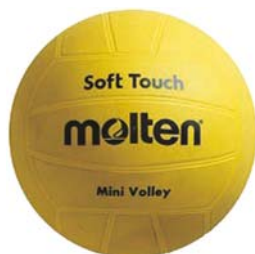

**Art. 6332**  
Pallone MINIVOLLEY  
in gomma Molten  
Molten rubber Minivolley ball

● pg.40



**Art. V33**  
Pallone MINIVOLLEY  
in gomma Trial  
Trial rubber Minivolley ball



**Art. V27**  
Pallone SUPERMINIVOLLEY  
in gomma Trial  
Trial rubber Superminivolley ball



**Art. 991725/ ... /991728**  
Kit elastici allenamento pallavolo  
soft/medium/hard/extra hard  
Elastics for volleyball training  
soft/medium/hard/extra hard



**Art. ULT26-3 / ULT27-3**  
Pallone MINIVOLLEY/  
SUPERMINIVOLLEY  
in gomma triplo strato Trial  
Trial triple stratum Minivolley/  
Superminivolley ball



**Art. MV70**  
Pallone MINIVOLLEY "First Touch"  
Molten in nylon gr.70  
(ad esaurimento)  
Molten nylon Minivolley ball  
(until available)

## BEACH VOLLEY

**Art. 1051** Impianto Beach Volley regolamentare in alluminio Ø mm.80 (rete esclusa) altezza rete regolabile anche per Beach Tennis  
Beach volley posts in aluminium (net not included) adjustable height net also for Beach Tennis

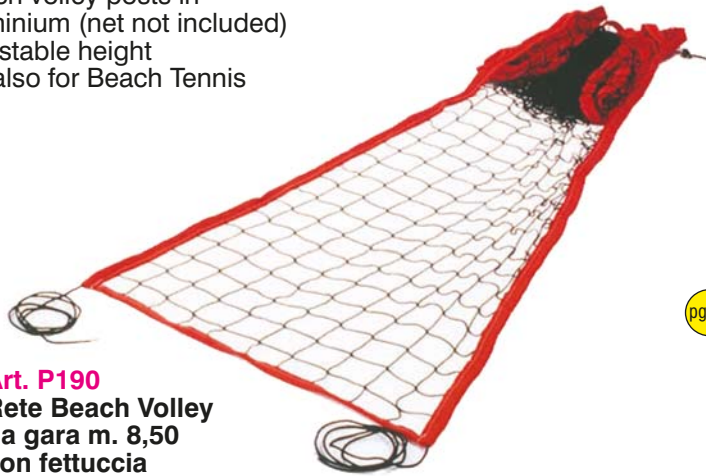

**Art. P190** Rete Beach Volley da gara m. 8,50 con fettuccia su tutto il perimetro  
Beach volley match net

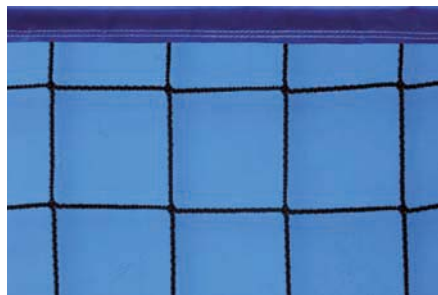

**Art. P170** Rete Beach Volley m. 8,50 con fettuccia sul lato superiore  
Beach volley net



Lato A Lato B

**Art. BVMBP** Coppia protezioni per impianto Beach Volley regolamentare altezza cm. 200 diametro cm. 8  
Pair of Beach Volley posts soft protections

**Art. V5513** Impianto Beach Volley in alluminio (rete esclusa) senza bussole altezza rete regolabile anche per Beach Tennis  
Beach Volley posts in aluminium (net not included) with no sockets adjustable height net also for Beach Tennis



**Art. V5510** Impianto Beach Volley in acciaio zincato (rete esclusa) altezza rete regolabile anche per Beach Tennis  
Beach Volley posts in galvanized steel (net not included) adjustable height net also for Beach Tennis

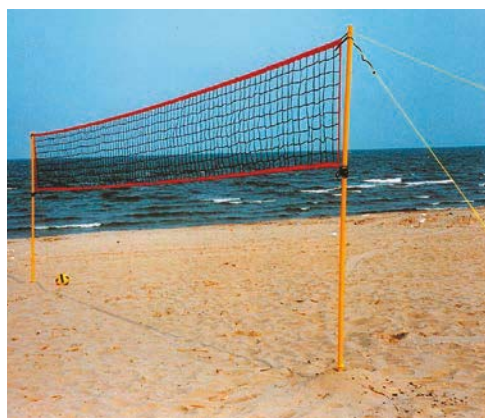

**Art. F501** Impianto Mini Beach Volley portatile con pali telescopici in ferro verniciato completo di rete mt. 6,5x1 e sacca  
Mini Beach Volley complete set





**Art. V5543**

**Seggiolone per arbitro Beach Volley in acciaio ovale verniciato a polveri sez. mm.60 antinfortunistico e richiudibile in soli 45 cm.**  
Beach Volley referee's Stand

**Art. V5428**

**Set imbottiture per seggiolone Art. V5543**  
Set of Soft Protections for Art. V5543

pg.40



**Art. P17**

**Kit Delimitazione campo Beach Volley**  
2 nastri m.16 + 2 nastri m. 8 + 8 picchetti + 8 elastici  
nastri larghezza mm. 50 occhiellati alle estremità  
Set for Beach Volley Bounds

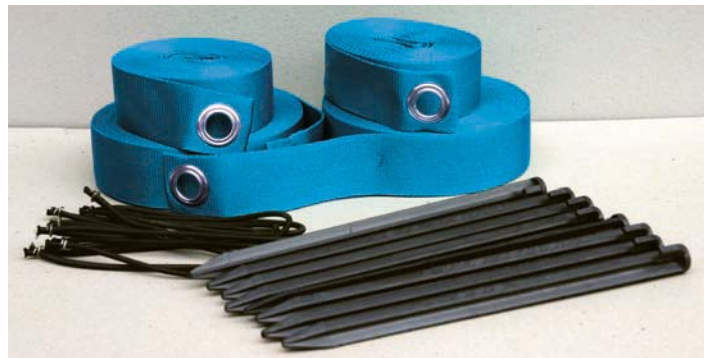

**Art. P19 Kit Delimitazione regolabile per campo Beach Volley e Beach Tennis** 2 nastri m.16 + 2 nastri m.8 oppure 2 nastri m.18 + 2 nastri m.9 colore blu  
Set for Beach Volley and Beach Tennis bounds adjustable blue color



**Art. M13719**

**Pallone Beach Volley Mondo BV 2000**  
in pelle sintetica  
Mondo Beach Volley ball

pg.40



**Art. 6340**

**Pallone Beach Volley da gara Molten V5B5000**  
**Pallone ufficiale FIVB**  
Molten Beach Volley match ball



**Art. 29097**

**Pallone Beach Volley Molten "Sweet Touch"**  
Molten Beach Volley ball



## PROTEZIONI - Protections



pg.39

**Art. E6644**

**Paio ginocchiere Volley trapuntate misura S, M, L  
colori royal, navy, nero, rosso, fucsia, giallo fluo, verde fluo**  
Pair of knee protections size S, M, L



**Art. E6645**

**Paio ginocchiere Volley senza foro  
posteriore con imbottitura modellata  
JR e SR colori blu o nero**  
Pair of knee protections for match size JR and SR



**\*\*Art. 9293**

**Paradenti singolo  
taglia adulto**  
Adult Mouthguard

**\*\*Art. 9293.B**

**Paradenti singolo  
taglia bambino**  
Junior Mouthguard

**\*\*Disponibili  
anche senza  
reggi-paradenti**



**Art. 43602A**

**Paradenti doppio  
taglia S-L**  
Double Mouthguard Size S-L



**Art. E6641**

**Paio ginocchiere Volley  
regolabili con velcro, misura SR colori blu e nero**  
Pair of pro knee protections size SR adjustable with  
velcro - colors black and blue



**Art. PDFOX**

**Paradenti Fox singolo  
taglia adulto - vari colori**  
Adult Fox mouthguard - various colors



**Art. E6633 Paio gomitiere Volley, misura JR e SR  
colori royal, rosso e nero**  
Pair of elbow protections size JR and SR



pg.40



**Art. ESPN**

**Maschera di  
protezione per  
naso, zigomi  
e arcata  
sopracciliare**  
Face Protection  
Mask



**Art. 73001**  
**Sospensorio  
con conchiglia,  
misura S, M, L**  
Shell Protection  
size S, M, L



Art. E6649

Art. E6650

Art. E6670

**Art. E6649**

**Paio ginocchiere elasticizzate misura S-M-L-XL**  
Pair of elastic Knee Protections size S-M-L-XL

**Art. E6650**

**Paio cosciere elasticizzate misura S-M-L-XL**  
Pair of elastic Thigh Protections size S-M-L-XL

**Art. E6670**

**Paio cavigliere elasticizzate misura S-M-L-XL**  
Pair of elastic Ankle Protections size S-M-L-XL



**Art. IS799**

**Ginocchiera con supporti rigidi**  
taglia S/M - L/XL  
Knee protection with metal support



**Art. E784**

**Ginocchiera in neoprene traspirante** taglia S-M-L  
Neoprene Knee Protection



pg.39

**Art. E786**

**Cavigliera in neoprene** taglia S-M-L-XL  
Neoprene Ankle Protection



**New!**

**Art. AHF-075**

**Polsiera stabilizzante in neoprene con foro per il pollice e chiusura regolabile in velcro**  
Stabilizing neoprene cuff with thumb hole and adjustable velcro closure



**Art. E798**

**Supporto Coscia in neoprene** taglia S-M-L-XL (XL ad esaurimento)  
Neoprene Thigh Protection



**Art. 90252A**

**Fascia sottrotulea in neoprene**  
Neoprene underknee band



**Art. 2651A**

**Short in neoprene vita alta colore nero** taglia S-M-L-XL  
Neoprene Shorts



**Art. E796**

**Supporto gomito in neoprene** taglia unica regolabile (ad esaurimento)  
Neoprene Elbow Protection one size fits all (until available)

**Art. AHF-079**  
**Pancierina in neoprene** taglia unica 120x25x0,4 cm  
Neoprene stomach band 25 cm. height



## IMPIANTI MULTIFUNZIONE Multi-purpose systems



### Art. S05206

**Impianto multifunzione professionale per volley, minivolley, tennis e salto in alto - basi zavorrate in acciaio zincato su ruote gommare, ritzi centimetrati in alluminio verniciato con cursore scorrevole**  
 Volley, Minivolley, Tennis and High Jump transportable system - galvanized weighted bases with wheels, posts in painted aluminium with slider



**Art. S05210**  
**Rete per impianti multifunzione**  
**Art. S05202/S05204/S05206/PA020**  
**dimensioni m. 9x1**  
 Net for multi-purpose systems size m. 9x1

**Art. 6780M**  
**Impianto volley e minivolley trasportabile zavorrato**  
 Weighted Volley and Minivolley transportable system

● pg.38



**Art. S05208**  
**Coppia tabelloni in plastica con canestro su supporto in acciaio per Art. S05206**  
 Pair of Basket Boards with baskets and steel back frames for Art. S05206



**Art. S05209**  
**Set protezioni per impianto multifunzione Art. S05206**  
 Soft Protection set for transportable system Art. S05206

● pg.42

● pg.43

### Art. S05202

**Impianto multifunzione volley, minivolley, badminton, tennis trasportabile zavorrato strutture verticali in acciaio zincato e verniciato, con ruote**  
 Volley, Minivolley, Badminton and Tennis transportable system



### Art. S05204

**Impianto multifunzione come Art. S05202 ma valido anche per basket (con tabelloni in plastica)**  
 Same of Art. S05202 but also for basket (with plastic boards)



**Art. PA020**  
**Impianto multifunzione trasportabile completo di protezioni**

Volley, Minivolley, Badminton and Beach Tennis transportable system

**Altezza rete (non inclusa) regolabile da cm. 91 a cm. 245**  
**Basi in ABS con ruote, riempibili con sabbia**



**Art. 7800G**  
Coppia porte pallamano  
in acciaio mm. 80x80  
(reti escluse)  
Pair of steel handball Goals

**Art. 7801G**  
Coppia porte pallamano  
in alluminio mm. 80x80  
(reti escluse)  
Pair of aluminium  
handball Goals

Le reti per porte  
pallamano  
corrispondono  
alle reti  
per porte calcetto  
m. 3x2  
Same nets as futsal  
goals m. 3x2

## PALLAMANO - Handball



**Art. SH1**  
Pallone Pallamano  
Trial Micro/Midi Handball  
per l'apprendimento  
dei fondamentali  
Trial Rubber Micro/Midi Handball  
helps in learning the basics



**Art. BA25 / BA0 / BA29 / BA30**  
Pallone Pallamano  
Trial in gomma supersoft  
junior / femminile  
Handball supersoft  
junior / size 2 in rubber



**Art. M13651 / M13650**  
Pallone Pallamano  
Mondo Golden  
pelle sintetica  
mis. 2 e mis. 3  
Handball size 2 and 3  
in synthetic leather

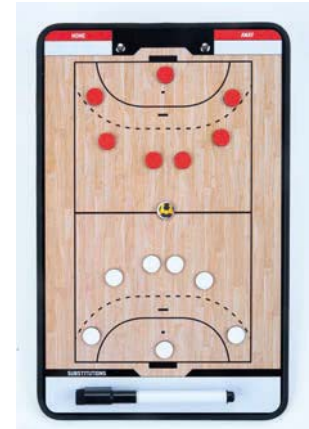

**Art. PTI.HB**  
Lavagna Pallamano  
bifacciale magnetica  
e cancellabile cm. 35x22  
Handball tactical board



**Art. V29 / V30 / V49 / ULT49-3 / ULT30-3**  
**ULT303.15 / ULT29-3 / ULT24-3**  
Pallone Pallamano in gomma  
Trial (mono e triplo strato) mis. 0-1-1,5-2-3  
Trial Handball in rubber (single and triple stratum)  
size 0-1-1,5-2-3

pg.40

pg.41



**Art. ULT34 / ULT35 / ULT36-3 / ULT37-3**  
Pallone Beach Handball in gomma Trial triplo strato  
mis. 00, 0, 2, 3  
Trial Beach Handball in rubber size 00, 0, 2, 3

**Art. ULTS29 / ULTD29**  
**ULTS30 / ULTD30**  
**ULTS49 / ULTD49**  
Pallone Pallamano  
gomma Trial  
potenziato  
Ø 15/17/18,5 cm.  
gr. 375/500/550/630/  
700/750 (+50% / +100%)  
Rubber Trial Heavier Handball



**Art. TRBH**  
Pallone Reaction Ball Trial  
doppio strato  
rimbalzo e traiettorie imprevedibili  
Trial Reaction Ball unpredictable  
rebounds - for Handball



**Art. BYCH**  
Pallone Pallamano  
bicolore gomma Trial  
Ø cm. 18,5 gr.420  
Trial bicoloured  
Handball

## TABELLONI ELETTRONICI BASKET, PALLAVOLO, MULTISPORT Electronic scoreboards for basketball, volleyball, multisport

pg.36



### Art. F160

Tabellone portatile MULTISPORT da tavolo con tastiera di comando per BASKET, VOLLEY, CALCETTO, PALLANUOTO, PALLAMANO, KICK BOXING, PING PONG ed altro punteggi da 0 a 199 per lato set/bonus/falli da 0 a 9 per lato cronometro massimo 99 minuti e 59 secondi periodi da 0 a 9 - altezza cifre cm.9 dim. cm. 55x35x9,5  
Multisport Table Scoreboard (for BASKET, VOLLEY, FUTSAL, WATER POLO, HANDBALL, KICK BOXING, TABLE TENNIS)



### Art. F345

Tabellone elettronico PLAY30-V con console solo tasti e m. 30 di cavo - dim. cm. 85x38x11 h. cifre cm. 17,4 - indicato per VOLLEY, PING PONG, BADMINTON, SQUASH punteggi 0-199 per lato - set/bonus da 0 a 9 per lato - possesso/priorità/turno lato dx o sx Electronic Board with console, dim. 85x38x11 cm. 17,4 cm. high figures



### Art. F351D

Tabellone MULTISPORT PLAY30-C con console a display luminoso per BASKET, VOLLEY, CALCETTO, PALLAMANO ed altro punteggi da 0 a 199 per lato - set/bonus/falli da 0 a 9 per lato - cronometro 99 minuti e 59 secondi altezza cifre punteggio cm.17,4 - altezza cifre cronometro cm.15 - segnalazione acustica di fine tempo dim. cm.75x59x10 - Peso Kg.12,4 cavo console 60 metri  
Multisport scoreboard PLAY30-C dim. 75x59x10 cm.



pg.37

### Art. F300-14

Cronometro da esterno (minuti + secondi) dim. cm.166,5x59x15 - h. cifre cm. 45 con console  
Timer for outdoor with console



**Art. F3045015**

Tabellone MULTISPORT dimensioni cm.91x60x9,5 peso Kg.10 - utilizzabile per BASKET, VOLLEY, CALCETTO, PALLAMANO, PALLANUOTO, TENNIS, PING PONG, BADMINTON altezza cifre cm.15 - visualizzazione di punteggi, cronometro, timeout, falli squadra, periodo, possesso palla.

Console Art. F307-01 o Art. F308-01 non inclusa

Electronic Board, dim. 91x60x9,5 cm.

15 cm. high figures for various sport.

Console Art. F307-01 or Art. F308-01 not included

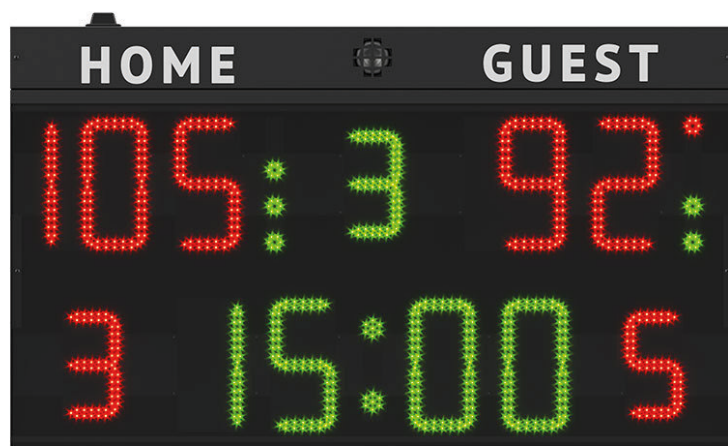

**Art. F3045025**

Tabellone segnapunti MULTISPORT

Omologato FIBA livello 3

(BASKET, VOLLEY, CALCETTO, TENNIS, PING PONG, PALLAMANO, PALLANUOTO, BADMINTON)

altezza cifre cm.25 distanza di leggibilità m.110

peso Kg.22 - dimensioni cm.140x83x9

da utilizzare con console Art. F308-01 (non inclusa)

Electronic Board, dim. 140x83x9 cm.

25 cm. high figures for various sport.

Console Art. F308-01 not included



**Art. F268-02**

Kit indicatori elettronici 24-30 secondi wireless

h. cifre cm.20 - dim. cm.28,5x32x10 cadauno

completo di console Art. F308-01

visualizzazione del tempo di tiro segnalatore acustico di fine tempo

Kit 24 second indicators wireless with console Art. F308-01

pg.36



**Art. F307-01**

Console 300 per Art. F3045015

Display LCD - utilizzabile per collegamento via cavo

dim. cm.28,5x10,5x8

Console for Art. F3045015 with cable system



**Art. F308-01**

Console 700 per Art. F242,

Art. F3045025 e Art. F3045015

Display touchscreen - utilizzabile per collegamento sia via cavo che via radio

dim. cm.24,5x17x8,5

Console for Art. F242, Art. F3045025

and Art. F3045015 with cable or radio system

pg.37

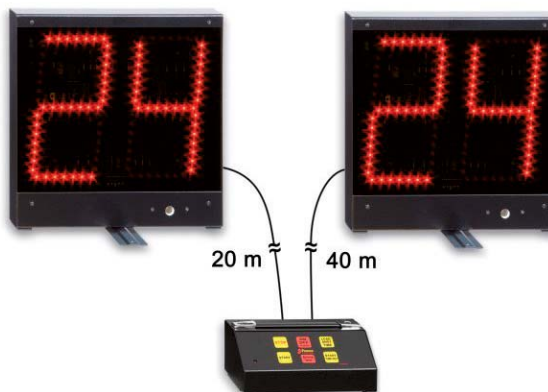

**Art. F270**

Kit indicatori elettronici 24 secondi

h. cifre cm.20 - dim. cm.29,2x30,4x4,4 cadauno

completo di centralina munita di tastiera

visualizzazione del tempo di tiro e del timeout

segnalatore acustico di fine tempo, un cavo m.20

e un cavo m.40 in dotazione

Kit 24 second indicators with console



**Art. F242**

**Tabellone MULTISPORT FS-130**  
 dimensioni cm.200x180x9 - peso Kg.60  
 costruito secondo le disposizioni FIBA  
 utilizzabile per BASKET, VOLLEY, CALCETTO,  
 PALLAMANO, HOCKEY, TENNIS, PALLANUOTO  
 altezza cifre cm.30 tempo di gioco 99:59  
 punteggi di squadra (da 0 a 199) - periodo (0 - 9)  
 falli di squadra/set vinti (da 0 a 9) - bonus  
 (1 punto luminoso per squadra)  
 timeout (3 punti luminosi per squadra)  
 possesso/servizio/turno: frecce indicatrici  
 indicazione ultimo fallo avvenuto  
 (numero di maglia del giocatore e numero del fallo)  
 Console Art. F308-01 non inclusa  
 Electronic Board, dim. 200x180x9 cm.  
 30 cm. high figures for various sport  
 Console Art. F308-01 not included



**Art. F258-51**

**Tabellone elettronico indicatore dei  
 24 secondi e tempo di gioco FS-24s-1**  
 dim. cm.70,5x60x11,5 h. cifre cm.14  
 e cm.30 - da collegare con  
 Art. F253-21, completo di cavo m.50  
 per collegamento alla console  
 Art. F308-01 - protetto contro gli urti  
 della palla - *N.B. Per un impianto  
 Basket completo occorrono  
 n. 2 Art. F253-21 + n. 2 Art. F258-51*  
 24 second indicator board



pg.37

**Art. F308-01**

**Console 700 per Art. F242,  
 Art. F3045025 e Art. F3045015**  
 Display touchscreen - utilizzabile per  
 collegamento sia via cavo che via radio  
 dim. cm.24,5x17x8,5  
 Console for Art. F242, Art. F3045025  
 and Art. F3045015 with cable or radio system

**Art. F253-21**

**Kit cornice  
 luminosa e  
 centralina di  
 comando per  
 tabellone basket  
 Ledstrip cm.515**  
 Kit light frame and  
 control unit for  
 basketball board  
 Ledstrip 515 cm.

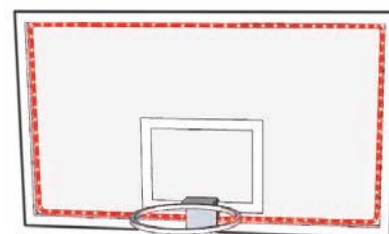

pg.37



**Art. F265-20**

**Ricevitore radio per collegamento del  
 tabellone indicatore 24 secondi**  
 Art. F258-51 alla console Art. F308-01  
*N.B. Per un impianto  
 Basket completo occorrono  
 n. 2 Art. F253-21 + n. 2 Art. F258-51  
 + n. 2 Art. F265-20*  
 Radio receiver connecting  
 Art. F258-51 to Art. F308-01



**Art. F300-26**

**Tabellone elettronico da esterno**  
 ideale per CALCIO, CALCIO RIDOTTO E CALCETTO  
 dim. cm.166,5x118x15 - altezza cifre 45cm.  
 Punteggio squadre da 0 a 9 - Cronometro 99:59  
 orologio - resistente agli urti della palla,  
 da utilizzare con console Art. F308-01 (non inclusa)  
 Electronic scoreboard for outdoor - ideal for Soccer,  
 Futsal - resistant to ball hits  
 (console Art. F308-01 not included)

**TENNIS - PADEL**

**Art. 8820G**  
Coppia Pali Tennis in acciaio verniciato a sezione quadra con bussole da interrare e tendirete  
Tennis Posts in painted steel with underground sockets

**Art. 1058**  
Coppia Pali Tennis da fissare al pavimento in acciaio verniciato a sezione quadra e tendirete in bronzo ad arganello  
Tennis Posts in painted steel for ground fixing

**Art. 1059**  
Coppia Pali Tennis da fissare al pavimento in alluminio e tendirete in bronzo ad arganello  
Tennis Posts in aluminium for ground fixing

**Art. 1056**  
Coppia Pali Tennis in acciaio zincato e verniciato a sezione quadra con bussole da interrare e tendirete in bronzo ad arganello  
Tennis Posts in galvanized and painted steel with underground sockets

● pg.41 ● pg.42



**Art. 8819G**  
Coppia Pali Tennis in alluminio con bussole da interrare e tendirete  
Tennis Posts in aluminium with underground sockets

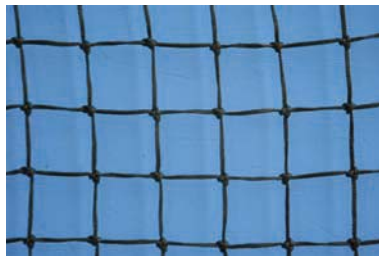

**Art. T030**  
Rete Tennis annodata m.12,80 x 1 - sp. mm. 2,5 (centro rete non incluso)  
Tennis knotted net (Art. RT1 not included)



**Art. T040**  
Rete Tennis da gara annodata modello Wimbledon m.12,80 x 1 - sp. mm. 3,5 (centro rete Art. RT1 non incluso)  
Tennis knotted match net (Art. RT1 not included)

**Art. RT1**  
Centro rete  
Net central holder

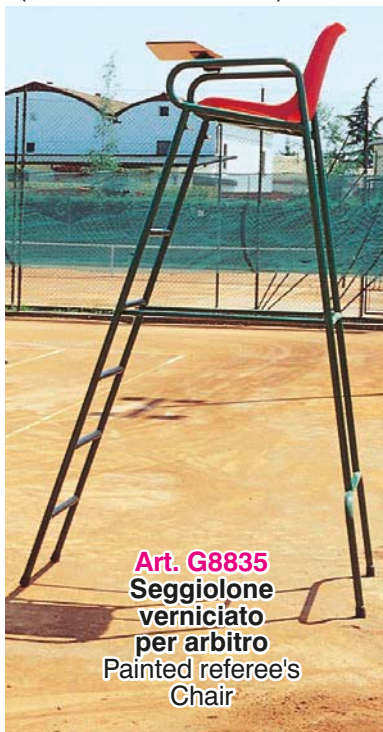

**Art. G8835**  
Seggiolone verniciato per arbitro  
Painted referee's Chair



**Art. TE10030**  
Impianto Junior Tennis cm. 500x100 in acciaio trasportabile (rete esclusa)  
Transportable junior Tennis posts in steel (net not included)

**Art. TE10031**  
Rete per impianto Art. TE10030  
Net for Art. TE10030



**Art. S04862**  
Impianto Tennis in acciaio zincato trasportabile (rete e zavorra escluse)  
Transportable Tennis posts in galvanized steel (net and weights not included)



**Art. S04868**  
Coppia paletti per singolo in acciaio verniciato  
Pair of steel poles for single





**Art. RTAD / RTB912 / RTB58**  
**Racchetta Tennis Dunlop in lega**  
 27" (adulti) - 25" (9/12 anni) - 23" (5/8 anni)  
 Tennis rackets



**Art. AGDP**  
**Tube 3 palle Tennis**  
**depressurizzate**  
 Dunlop  
 (rimbalzo ridotto  
 del 50% per scuole  
 tennis)  
 Set 3 depressurized  
 Tennis balls

pg.41 pg.42



**Art. 44.045 Over Grip**



**Art. E6620**  
**Paio Polsini**  
 tergisudore  
 altezza cm. 7  
 Pair of  
 Wrist bands



**Art. E6610**  
**Fascia**  
 tergisudore  
 altezza cm. 5  
 Headband



**Art. T4D**  
**Tube 4 Palle Tennis**  
 Head Championship  
 Set 4 Tennis Balls



**Art. T4DAC**  
**Tube 4 Palle Tennis**  
 Dunlop Fort All Court  
 Set 4 Tennis Balls



**Art. TPAPD**  
**Tube 3 Palle Padel**  
 Dunlop Team  
 Set 3 Padel Balls

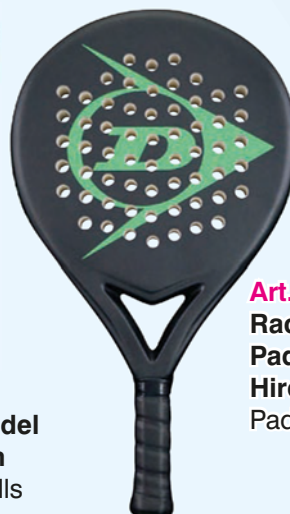

**Art. T043**  
**Rete PADEL**  
 m.10x0,92  
 Padel net

**New!**

**Art. RPDH**  
**Racchetta**  
 Padel Dunlop  
 Hire  
 Padel Racket

**Art. 07861 Set 3 palline tennis in gommapiuma**  
 Set 3 foam rubber tennis balls



## BEACH TENNIS



**Art. 48018**  
**Racchetta Beach Tennis in resina**  
 (il colore e la grafica possono variare)  
 Beach Tennis racket

pg.42



**Art. PT41**  
**Pallina Beach Tennis**  
 Beach Tennis ball



**Art. P210**  
**Rete Beach Tennis**  
 con fettuccia su tutto  
 il perimetro  
 Beach Tennis net



**Art. TE220.40** Macchina lancia palline  
velocità max 130 km/h  
velocità min 30 km/h  
frequenza lancio da 2 a 15 secondi  
Ball throwing machine



**Art. TE51.04**  
Rullo in acciaio con racla  
Levelling roller



**Art. RT10046**  
Cestino raccogli-palle  
con manici ribaltabili  
Ball collection basket with  
folding handles



**Art. RT10**  
Stuoia livellatrice per campi in terra  
battuta m.2x1,5  
Levelling net m.2x1,5

pg.42

**Art. RT3**  
Rotolo m. 150  
strisce segnacampo  
Tennis in PVC mm. 50  
150 m. set  
Tennis lines in PVC



**Art. 0934N**  
Rete protezione  
polietilene verde annodata  
maglia cm. 4,5x4,5 sp. mm. 2  
Protection Net green polyethylene  
mesh 4,5x4,5 cm.  
knotted, thick 2 mm.



**Art. 40/S - 41/S**  
Telo fondo campo Tennis  
densità 90% o 70% mt.18x2  
con banda di rinforzo  
Tennis perimeter net density  
90% or 70% dim. 18x2 meters



**Art. TE53083**  
Tabellone segnapunti Tennis  
cm. 100x77 h. cifre cm. 12  
completo di agganci per la recinzione  
Tennis scoreboard 100x77 cm.



**Art. F166PST**  
Tabellone  
elettronico  
portatile da tavolo  
per Tennis  
Portable Tennis  
electronic  
scoreboard

## TENNIS TAVOLO - Table Tennis



**Art. TEC.I**  
**Tennis tavolo Tectonic indoor per interno**  
Indoor Table Tennis Tectonic

**Art. TEC.O**  
**Tennis tavolo Tectonic outdoor per esterno**  
Outdoor Table Tennis Tectonic



**Art. C250.I**  
**Tennis tavolo Cornilleau modello Sport 250 da interno**  
Indoor Table Tennis Cornilleau Sport 250

pg.43



**New!**

**Art. C200X.O**  
**Tennis tavolo Cornilleau modello Sport 200X da esterno**  
Outdoor Table Tennis Cornilleau Sport 200X



**Tutti i tavoli sono pieghevoli e su ruote**  
All models are foldable and on wheels



**New!**



**Art. C500X.O**  
**Tennis tavolo Cornilleau**  
**modello 500X da esterno**  
Outdoor Table Tennis  
Cornilleau 500X

● pg.43



**Art. C500.I**  
**Tennis tavolo Cornilleau**  
**modello 500 da interno**  
Indoor Table Tennis  
Cornilleau 500



**Art. C510.O**  
**Tennis tavolo Cornilleau**  
**modello 510 da esterno**  
Outdoor Table Tennis  
Cornilleau 510



**Art. 568001**  
**Racchetta**  
**Ping Pong**  
**Dunlop**  
**Nitro**  
 (o modello simile)  
 Dunlop  
 table tennis bat



**Art. 83925A**  
**Racchetta**  
**Ping Pong**  
**Dunlop**  
**Evolution 1000**  
 (o modello simile)  
 Dunlop  
 table tennis bat



**Art. 48441**  
**Confezione 6 Palline**  
**Dunlop Championship**  
 Set of 6 table tennis balls



**Art. 2C4118C**  
**Confezione 100 Palline**  
**1 stella colore bianco**  
 Set of 100 table tennis balls

pg.43



**Art. 17362**  
**Confezione 3 Palline**  
**Stiga 3 stelle Perform**  
 Set of 3 Stiga table tennis balls



**Art. PP50**  
**Rete in polietilene**  
 Table Tennis Net



**Art. E5019**  
**Rete Ping Pong**  
**regolabile portatile universale**  
 Table tennis net adjustable length



**Art. 48448**  
**Set rete con paletti**  
 Table Tennis Net  
 with holder



**Art. PPP30**  
**Segnapunti per Ping Pong con numeri da 0 a 30 rinforzati**  
 Table tennis scoreboard

## RUGBY



**Art. 8836G1 / 8836G**  
**Coppia Porte Rugby**  
**in alluminio verniciato**  
**m. 11 / m. 9,6 fuori terra**  
**Rugby Goals**  
**in painted aluminium**

**Art. 993156/993157/993162**  
**Protezione imbottita per palo porta rugby**  
**h. cm. 200, modello**  
**quadrato oppure tondo**  
**Soft Protection for rugby goal post, square**  
**and round shape, height 200 cm.**



**Art. M13537**  
**Pallone rugby**  
**Mondo Touche**  
**in gomma**  
**(disponibile fino ad**  
**esaurimento scorte)**  
**Mondo rubber rugby**  
**training ball**  
**(until available)**

pg.44



**Art. V71**  
**Pallone mini-rugby Trial**  
**in gomma monostrato**  
**gr. 350 dim. cm.15/27**  
**Trial rubber mini-rugby Ball**  
**single stratum**



**Art. ULT71**  
**Pallone mini-rugby Trial**  
**in gomma doppio strato**  
**gr. 350 dim. cm.15/27**  
**Trial rubber mini-rugby Ball**  
**double stratum**

**Art. ULT70**  
**Pallone rugby Trial**  
**in gomma doppio strato**  
**gr. 450 dim. cm.19/28**  
**Trial rubber rugby Ball**  
**double stratum**



**Art. F1645X**  
**Pallone football americano**  
**in pelle sintetica**  
**Wilson Extreme ball**

pg.44

**Art. 993164**  
**Protezione copri bandierina**  
**cm.10x10x100h.**  
**Protection for rugby flag pole,**  
**10x10x100 cm.**



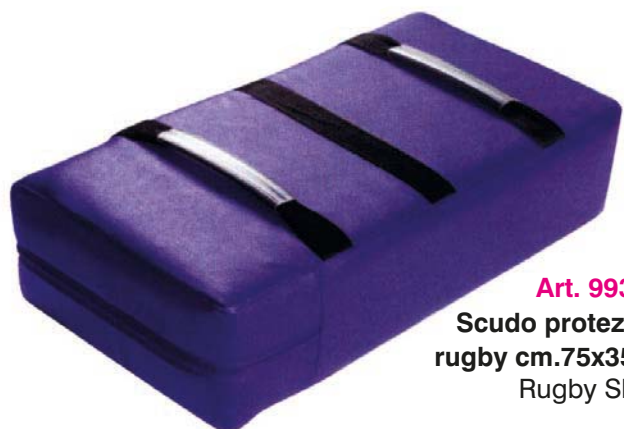

**Art. 993032**  
**Scudo protezione**  
**rugby cm.75x35x15**  
 Rugby Shield



**Art. 6M18**  
**Confezione 100 Tacchetti rugby**  
**mm.18 in alluminio**  
 Rugby aluminium studs  
 18 mm. 100 piece pack



**Art. 993151 / 993153JR**  
**Sacco placcaggio rugby h. cm.140 o cm.120**  
**diam. cm. 45 o cm. 35, con 3 maniglie**  
 Sac for Tackling height 140 or 120 cm.  
 diameter 45 or 35 cm. with 3 handles

pg.44



**Art. PTI.RU**  
**Lavagna Rugby bifacciale**  
**magnetica e cancellabile**  
**cm. 35x22**  
 Rugby tactical board  
 35x22 cm.

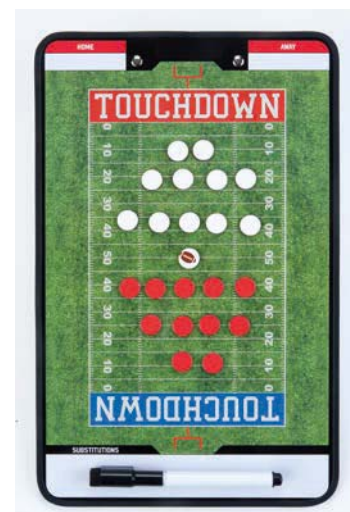

**Art. PTI.FA**  
**Lavagna Football**  
**Americano bifacciale**  
**magnetica e cancellabile**  
**cm. 35x22**  
 Football tactical board  
 35x22 cm.



**Art. FLFT**  
**Kit Flag Football composto da cintura regolabile e 2 flag - vari colori**  
 Flag Football kit with adjustable belt and 2 flags - various colors

## PISCINA - Swimming Pool



**Art. E1901**  
Cuffia in poliester  
(bicolore solo taglia adulto)  
Polyester cap

pg.43



**Art. E1904**  
Cuffia in lycra  
Lycra cap



**Art. E1127**  
Cuffia in silicone  
Silicone cap



**Art. E2607**  
Stringinaso con  
cuscinetti in silicone  
Silicone nose-clip



**Art. E2608**  
Tappi auricolari in silicone  
automodellanti - Set da 4 pz.  
Silicone auricular plugs



**Art. E2620**  
Occhialini  
da piscina Junior  
Junior glasses



**Art. E2626**  
Occhialini  
da piscina adulto antifog  
monococca morbida  
Senior antifog glasses



**Art. E2618**  
Occhialini da piscina adulto antifog  
monococca morbida  
custodia con cerniera  
Senior soft antifog glasses  
case with zip



**Art. E2622**  
Occhiale maschera  
antifog monococca morbida  
con custodia rigida  
Mask glasses antifog with case



**Art. E2639**  
Tavoletta per piscina adulto  
professionale cm.40x27  
Senior professional board



**Art. E2641**  
Ostacolatore monoblocco  
cm.15x22x7,5  
Swim hinder



**Art. E2650**  
Paio palette palmari forate  
cm.21x16 (misura S, M, L)  
Pair of perforated palm palettes



**Art. E2660**  
Copriscarpe in PVC  
set da 2000 pezzi  
misura unica  
PVC shoe covers





**Art. E848**  
Marsupio per nuoto potenziato  
Swimming pouch



**Art. E845**  
Paracadute per nuoto potenziato  
Swimming parachute



**Art. E482**  
Paio polsiere/cavigliere per aquagym mis. cm. 62x11x2  
Water aerobics wrist/ankle supports



**Art. E483**  
Paio manubri per aquagym cm.30 - diam. cm.14  
Water aerobics dumb bells

pg.43 pg.44



**Art. E474**  
Paio clavette per aquagym  
Water aerobics clubs



**Art. E488**  
Cintura per aquagym cm.72x24x4  
Water aerobics belt



**Art. E479/3**  
Zattera in espanso forata dim. cm.200x100x3  
Pierced mat

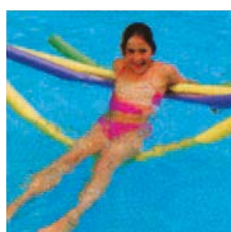

**Art. E470**  
Cilindro in materiale espanso per aquagym cm. 160 ø cm. 7  
Water aerobics bar



**Art. E2637/0**  
Paio manicotti arrotolabili doppia valvola (3/6 anni)  
Brackets



**Art. E480/1**  
Connettore per cilindro mis. cm.14 - 2 fori  
Bar connector



**Art. AQSA**  
Step per aquagym impilabile ad incastro cm.70x35x19  
Water aerobics step cm.70x35x19

## PALLANUOTO - Waterpolo

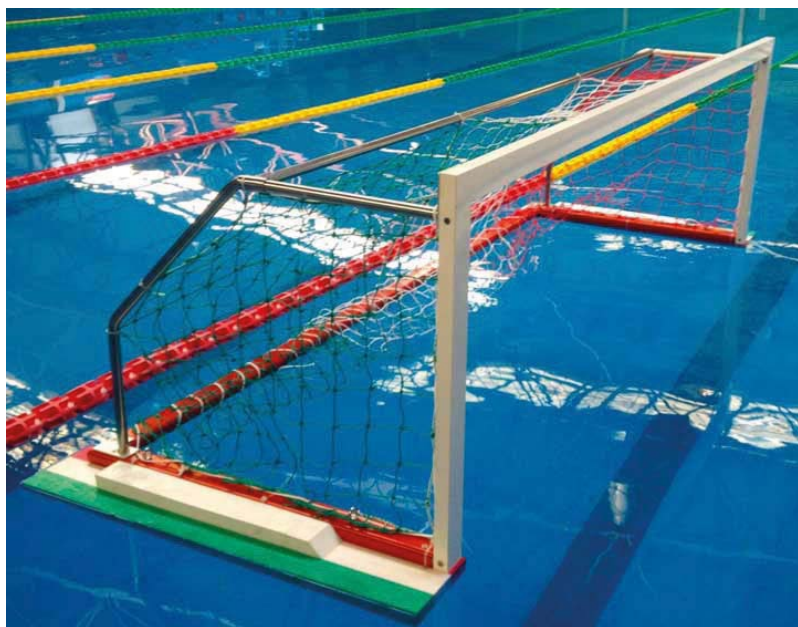

### Art. PPNR

#### Coppia Porte da pallanuoto per partite ufficiali (reti incluse)

Pair of Waterpolo Goals for official matches (nets included)

- Realizzate a norma F.I.N.A.
- Luce interna specchio di porta m.3x0,90
- Ingombro totale m.3,50x0,975x1,25
- Specchio di porta tubolare alluminio mm.75x40x1,85 di colore bianco
- Base tubolare alluminio mm.80x40x3 colore rosso
- Accessori acciaio inox AISI 316
- Galleggianti schiuma espansa a cellule chiuse densità 350% - Peso kg.30

### Art. 175P

#### Coppia reti per porte pallanuoto

Waterpolo Nets

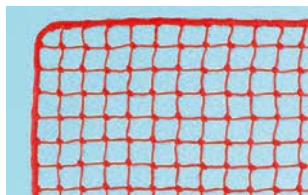

● pg.43



### Art. AQPP

#### Coppia Miniporte da pallanuoto in PVC m. 1,5x0,8 complete di reti

Pair of Waterpolo PVC Mini-goals 1,5x0,8 m. nets included



### Art. E6890

#### Pallone pallanuoto

Waterpolo Ball



### Art. 30415

#### Set 13 cuffie pallanuoto con numero colore bianco o blu

Set of 13 Waterpolo caps with numbers

## BADMINTON



**Art. P160**  
**Rete**  
**Badminton**  
**cm. 610x70**  
Badminton Net

**V7700**  
**Impianto Badminton**  
**professionale in acciaio verniciato**  
**zavorrato, su ruote, con tendirete**  
**(rete esclusa)**  
Pro Badminton set (net not included)



**Art. 23461**  
**Racchetta Badminton**  
**in acciaio/alluminio**  
Badminton Racket  
in steel/aluminium

pg.45



**Art. PAC12**  
**Racchetta Badminton**  
**in grafite/alluminio**  
Badminton Racket  
in graphite/aluminium



**Art. 22309**  
**Confezione**  
**6 Volani**  
**Badminton**  
**interamente**  
**in plastica**  
Plastic  
Shuttlecock  
6 piece pack

**Art. AS85**  
**Confezione**  
**6 Volani**  
**Badminton**  
**con capsula**  
**in sughero**  
Cork tip  
Shuttlecock  
6 piece pack

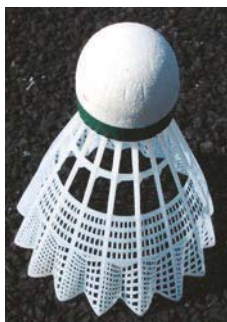

**Art. JIN**  
**Impianto**  
**Mini Badminton**  
**mt. 4,20x1,50**  
**telescopico portatile**  
**completo**  
**di rete e borsa**  
Portable Mini  
Badminton  
set mt. 4,20x1,50  
with net and bag

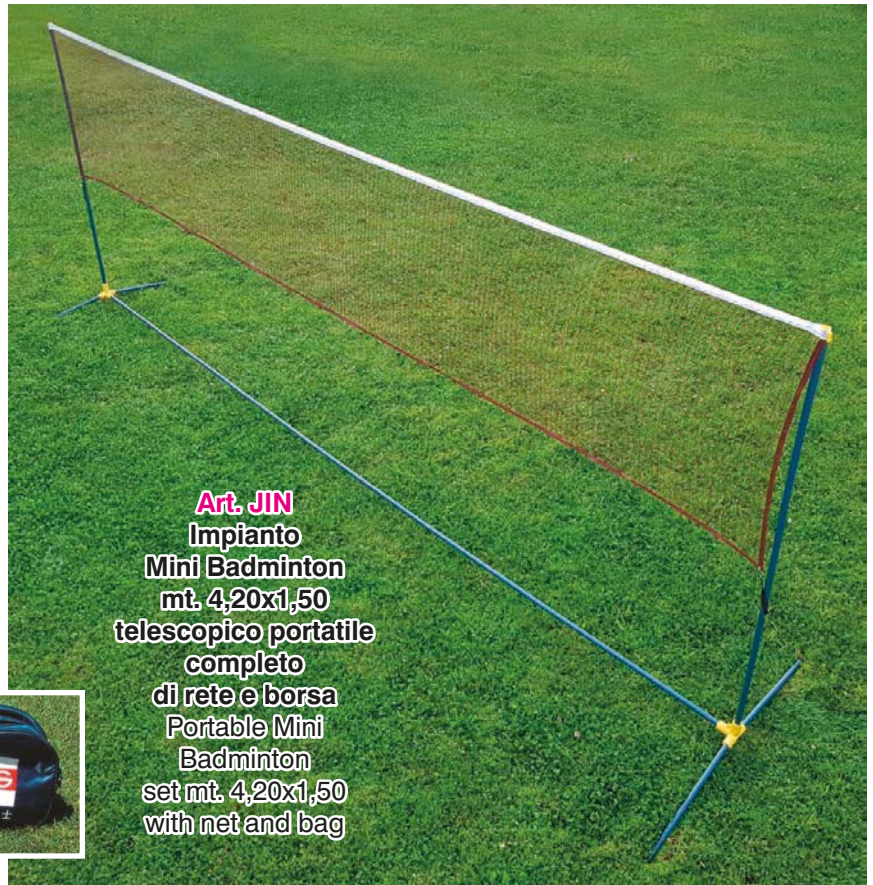

## HOCKEY



**Art. S05128**

**Coppia porte per Hockey su pista  
in acciaio verniciato**  
Pair of Hockey Goals in painted steel



**Art. S05122**

**Coppia porte per Hockey su prato  
in legno e acciaio verniciato**  
Pair of Hockey Goals in wood  
and painted steel



**Art. PUH01**  
**Pallina Unihockey**  
Unihockey ball

pg.44

**Art. F806**

**Coppia porte Unihockey  
in acciaio verniciato con reti,  
dim. cm.150x110**  
Pair of Unihockey Goals in painted steel 150x110 cm.



**Art. S05134**

**Set Unihockey composto  
da 6+6 bastoni cm.80+10 e 3 palline**  
Set Unihockey made of 6+6 sticks and 3 balls

**Art. H1**

**Coppia RETI per porte da Hockey pista  
(indoor) in polipropilene maglia mm.45  
cm.300x200x100x100**  
Pair of Track Hockey Goal nets

**Art. H2**

**Coppia RETI per porte da Hockey  
ghiaccio in polipropilene complete di rete  
di sbarramento, maglia  
mm.20 - cm.193x122x75x120**  
Pair of Ice Hockey Goal nets

**Art. H3**

**Coppia RETI per porte da Hockey  
prato in polipropilene complete di rete  
di sbarramento, maglia  
mm.45 - cm.366x214x90x122**  
Pair of Field Hockey Goal nets

**Art. H4**

**Coppia RETI per porte da Hockey rotelle in  
polipropilene complete di rete di sbarramento,  
maglia mm.20 - cm.185x122x74x110**  
Pair of Roller Hockey Goal nets

## BOXE



**Art. 992030**  
**Sacco Boxe in vinile Kg.30**  
Vinyl boxing bag kg.30



**Art. 992040**  
**Sacco Boxe in vinile Kg.40**  
Vinyl boxing bag kg.40



**Art. 992050**  
**Sacco Boxe in vinile Kg.50**  
Vinyl boxing bag kg.50



**Art. C3003S**  
**Gancio a molla**  
**ammortizzatore per**  
**sacco boxe**  
Spring for boxing bag

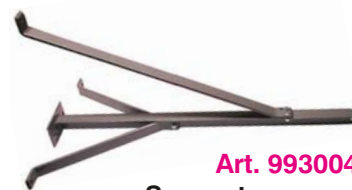

**Art. 993004**  
**Supporto a muro**  
**per sacco boxe**  
Iron wall support for  
boxing bag



**Art. 992840**  
**Sacco Boxe basculante**  
**h. cm. 170 zavorrato con**  
**sacchi di sabbia (inclusi)**  
Self-straightening boxing bag  
height cm.170



**Art. 992804**  
**Sacco Fit Boxe con pedana**  
**riempibile con acqua o sabbia,**  
**altezza regolabile (max cm. 220)**  
Freestanding Fit Boxing bag  
adjustable height



**Art. F350**  
**Kit pera**  
**su mensola**  
Pear for boxing

pg.52



**Art. 42233A**  
**Casco Boxe**  
misure S,M,L,XL  
Boxing helmet



**Art. 44613A**  
**Set protezioni**  
parastinco +  
parapiede  
misure S,M,L,XL  
Shin/foot protections

● pg.52



**Art. 17211**  
**Coppia Fasce Boxe**  
Boxing bandages



**Art. 54613A**  
**Guanti da Sacco in PU**  
taglie S,M,L,XL  
Bag gloves



**Art. 21796**  
**Guanti Fit Boxe**  
taglie S,M,L,XL  
Fit Boxing gloves

● pg.53



**Art. 74613A**  
**Guanti MMA in PU**  
taglie S,M,L,XL  
MMA gloves



**Art. 84613A**  
**Guanti Boxe**  
per combattimento  
non omologati  
8/10/12 oz.  
Boxing gloves



**Art. GN083**  
**Guanti Boxe**  
Leone Flash 10 oz.  
Leone Boxing  
gloves

## BASEBALL



**Art. TMB01**  
**Mazza Baseball supersoft Trial**  
 lunghezza cm.71 diametro cm.4/5  
 peso gr.460  
 Supersoft Trial Baseball bat



**Art. S05152**  
**Mazza Baseball regolamentare in legno**  
 Wooden Baseball bat



**Art. S05156**  
**Palla Baseball rivestita in pelle sintetica**  
 Baseball ball

pg.45

**Art. PTI.BB**  
**Lavagna Baseball**  
 bifacciale magnetica  
 e cancellabile  
 cm. 35x22  
 Baseball  
 tactical board  
 35x22 cm.



**Art. S05158**  
**Guantone Baseball**  
 in pelle sintetica  
 misura senior  
 Senior Baseball glove

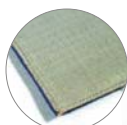

appoggio  
 antiscivolo



**Art. P21006**  
**Set basi didattiche**  
 antiscivolo colorate  
 Set of didactic anti-skid  
 bases



imbottitura  
 interna

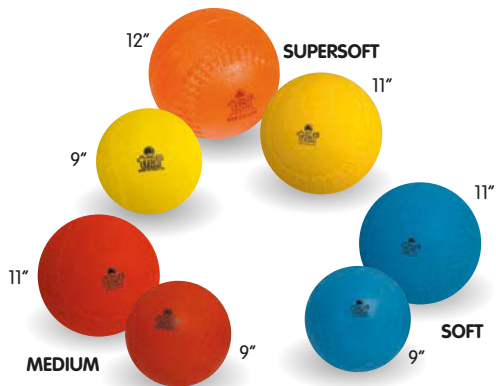

**Art. BSB.8**  
**Set 7 Palle Baseball/Softball**  
**Trial in gomma super soft**  
 diametri e grammature  
 assortiti  
 Set of Trial Baseball/Softball  
 balls



**Art. T21063**  
**Batting tee Trial**  
 supersoft  
 altezza regolabile  
 da cm. 65 a cm. 86  
 base diametro cm. 20,5  
 peso Kg. 3  
 Trial Batting tee  
 adjustable height

## ARTI MARZIALI - Martial Arts



**Art. 24772**  
**Divisa judo con cintura**  
**misure da 00 (cm.120)**  
**a 7 (cm.200)**  
 Judo strip with belt

pg.53



**Art. 24773**  
**Divisa karate con cintura**  
**misure da 00 (cm.120)**  
**a 7 (cm.200)**  
 Karate strip with belt



**Art. 23271**  
**Cintura judo/karate 100% cotone**  
**colori: nero, blu, arancio, marrone, verde, giallo, rosso**  
**misure da 1 a 7**  
 Judo/Karate belt



**Art. 23271.B**  
**Cintura judo/karate 100% cotone**  
**bicolore: bianco/giallo, giallo/arancio,**  
**arancio/verde, verde/blu,**  
**blu/marrone - misure da 1 a 7**  
 Bicoloured Judo/Karate belt



**Art. F163**  
**Tabellone elettronico**  
**portatile da tavolo**  
**per Kick-Boxing**  
 Kick-Boxing portable  
 electronic  
 Scoreboard



**Art. F162**  
**Tabellone elettronico**  
**portatile da tavolo**  
**per Karate**  
 Karate portable  
 electronic  
 Scoreboard

**Art. F150**  
**Fight Timer da parete**  
**cm.56x19x4 - kg.1,6**  
 Fight Timer





## MATERASSI - TAPPETI - Mats



### Art. B2001/ ... /B2016

Materassi di caduta realizzati in gommapiuma di varie densità con fodera di rivestimento in PVC antimuffa, antibatterico, ignifugo Cl.2

(vedere listino per le dimensioni)

Mats of various dimensions and thickness

Materassi e fodere disponibili anche con fondo antiscivolo (dettagli sul listino prezzi)

Mats and covers also available with anti-skid bottom (details on the price list)

● pg.45 ● pg.46 ● pg.47

### Art. B2033/ ... /B2047

Fodere di ricambio in PVC antimuffa, antibatterico, ignifugo Cl.2

(vedere listino per le dimensioni)

Spare covers for mats various dimensions



### Particolare Art. B2014/ B2015/B2016

(i materassi cm.200x400 sono costituiti da 2 pezzi tagliati a 45° e tenuti insieme da bande in velcro)

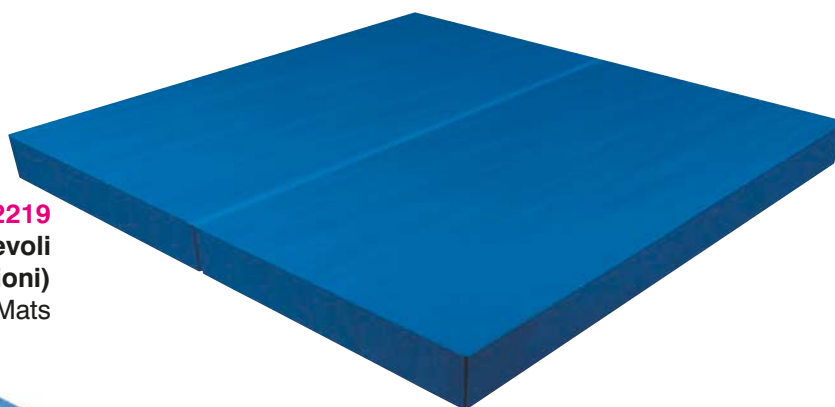

### Art. B2214/ ... /B2219

Materassi di caduta pieghevoli (vedere listino per le dimensioni)

Foldable Mats



● pg.47

### Art. B2228/ ... /B2231

Tappeti Gym Mat dim. cm.200x100 spessore cm.3-4-5-6 ad alta densità in polietilene a cellule chiuse (per uscita attrezzi)  
High density Gym Mats

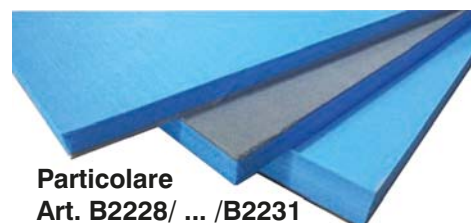

Particolare Art. B2228/ ... /B2231

**Più rigidi  
dei materassi in gommapiuma  
Harder than foam rubber mats**

**Art. S00676**  
**Carrello porta materassi**  
**cm. 200x100**  
**in acciaio verniciato**  
**mobile su ruote**  
Mat Trolley in painted steel size  
200x100 cm. on wheels

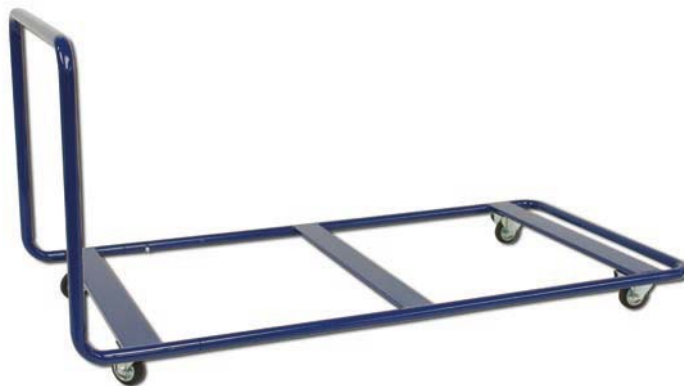

pg.46



**Art. S00678**  
**Carrello porta materassi**  
**in verticale cm. 250x105**  
**in acciaio verniciato**  
**mobile su ruote**  
**(elastici inclusi)**  
Vertical mat Trolley in painted  
steel size 250x105 cm.  
on wheels  
(elastics included)



pg.47

**Art. TEST.M**  
**Tappeto Mat Test cm.100x370**  
**con scala centimetrata da 0 a cm. 300**  
Mat Test 100x370 cm.

**Per allenamento tuffi portieri ed acrobazie giocatori**  
For GK dive and players' acrobatic shooting training

pg.45

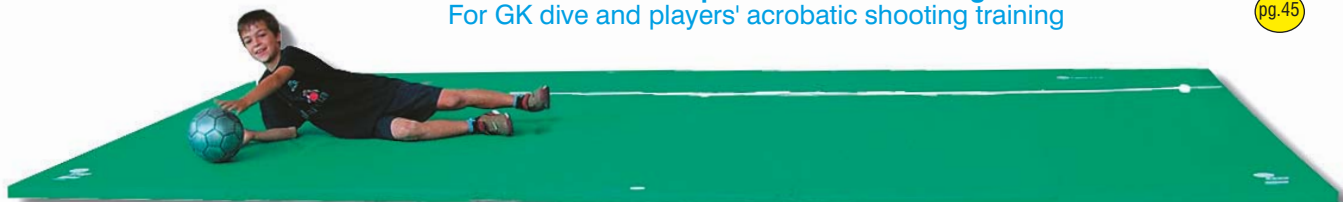

**Art. BGAP13**  
**Tappeto ammortizzante pieghevole dimensioni cm. 200x450 spessore cm. 3,5**  
**superficie in vinile, fondo antiscivolo, imbottitura in gommapiuma densità 40 Kg/mc**  
Foldable soft mat for goalkeeper and players' safe dives - size 200x450 cm. 3,5 cm. thick



## PROTEZIONI MURARIE E PER COLONNE - Wall protections



PREVENTIVO SU RICHIESTA  
PRICES ON REQUEST



### Art. B2085 / B2066

**Protezioni murarie e per colonna in vari spessori  
sagomate su misura in EVA oppure in PE ad alta densità rivestito in PVC  
fissaggio tramite occhiellature perimetrali, velcro oppure colla - per interno ed esterno  
Customized wall and column protections various thickness for indoor and outdoor**



pg. 45

**Art. A10100 / A10150 / A10200**  
**Protezioni paraspigolo in PVC espanso  
coestruso non ignifugo spessore cm. 1  
larghezza cm. 5+5 in vari colori  
lunghezza cm. 100-150-200**  
PVC Edge Protections 1 cm. thick  
width 5+5 cm.  
length 100-150-200 cm.

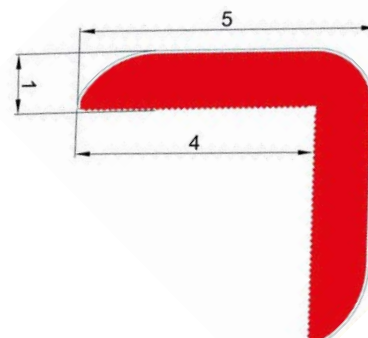

**Si applicano rapidamente  
mediante normale silicone**  
They are installed quickly by  
means of standard silicone

## TATAMI

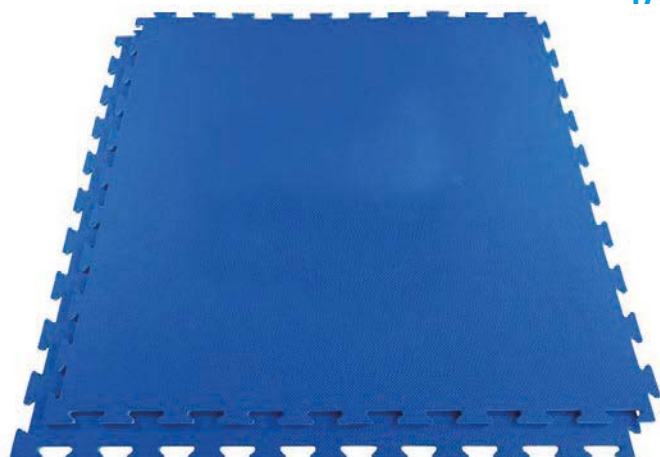

### Art. R10X

TATAMI ad incastro in EVA cm.100x100x1  
 colore blu con 4 bordi  
 superficie lavabile, antiscivolo  
 EVA Tatami soft flooring 100x100x1 cm.

pg.53

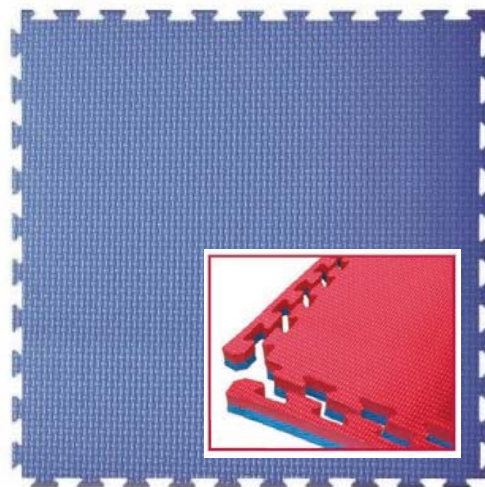

### Art. MAT02 / MAT04

TATAMI ad incastro cm.100x100x2  
 o cm.100x100x4 rosso/blu con 4 bordi  
 superficie lavabile, antiscivolo, antifunghi,  
 antibatterica, anallergica, certificato EN71  
 Tatami soft flooring 100x100x2 cm./100x100x4 cm.

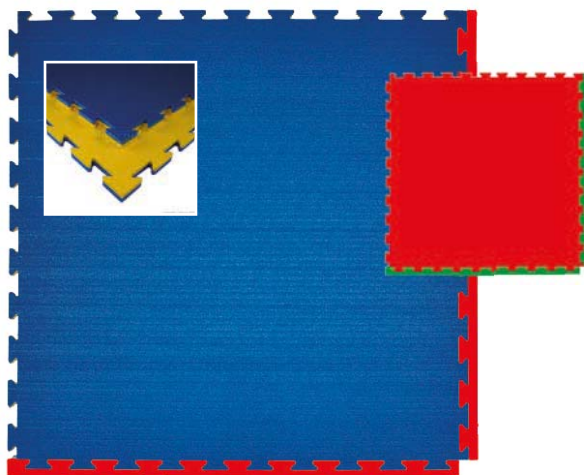

### Art. TX-K20

TATAMI Karate K20  
 cm. 100x100x2 ad incastro, reversibile  
 in polietilene espanso reticolato  
 incluso bordo protettivo perimetrale  
 colori: verde/rosso, rosso/blu, giallo/blu  
**(ordine minimo 8 pezzi)**  
 TATAMI K20 100x100x2 cm.  
 reversible, perimetric frame included  
 colors: red/green, red/blue, yellow/blue  
 (minimum order 8 pieces)

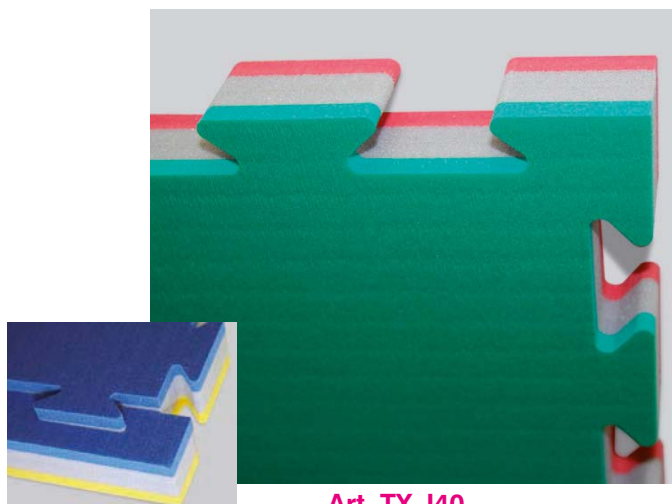

### Art. TX-J40

TATAMI Judo J40  
 cm. 100x100x4 ad incastro, reversibile  
 in polietilene espanso reticolato  
 incluso bordo protettivo perimetrale  
 colori: verde/bianco/rosso, giallo/bianco/blu  
**(ordine minimo 4 pezzi)**  
 TATAMI J40 100x100x4 cm. reversible,  
 perimetric frame included  
 colors: red/white/green, yellow/white/blue  
 (minimum order 4 pieces)



### Art. TX-2010

TATAMI tradizionale  
 cm. 200x100x4 in PU  
 densità 230 Kg/mc  
 rivestito in PVC  
 con fondo antiscivolo  
 colori: blu, verde, rosso, giallo  
**(ordine minimo 4 pezzi)**  
 TATAMI 200x100x4 cm.  
 in PU density 230 Kg/mc  
 cover with anti-skid PVC stratum  
 colors: blue, green, red, yellow  
 (minimum order 4 pieces)

## GINNASTICA - Gymnastic



**Art. S00352**

**Armadio porta attrezzi  
a 4 ripiani in lamiera  
con vano portavalori**

**dimensioni cm. 100x45x200h**

Equipment locker with safe-deposit box



**Art. S00354**

**Armadio porta attrezzi a 4 ripiani  
in lamiera dimensioni cm. 100x45x200h**

Equipment locker

pg.47



**Art. S00356**

**Armadio porta attrezzi  
in lamiera dimensioni  
cm. 120x45x200h  
a 4 ripiani  
e porte scorrevoli**

Equipment locker with  
sliding doors

pg.47

**Art. S00362**

**Mobile porta attrezzi su ruote  
Equipment trolley on wheels**

pg.23

**Art. F406**

**Armadio porta  
attrezzi in acciaio  
zincato a pareti  
smontabili,  
con ruote  
dimensioni  
cm. 156x76x163h**

Equipment locker in  
galvanized steel  
on wheels





**Art. CAGL**  
Coppia anelli in legno di faggio  
con cinghie nylon regolabili  
Pair of wooden rings with adjustable nylon belts

pg.47

**Art. S00002**  
Coppia anelli  
in legno lamellare  
Pair of wooden rings



**Art. S00018**  
Confezione da 8 pani  
magnesio gr. 55  
Chalk blocks



pg.48



**Art. E8000**  
Paio scarpette in pelle  
per ginnastica ritmica  
colore nero o bianco  
taglie da 26 a 46  
Pair of shoes for rhythmic gym  
color black or white



**Art.S00512**  
Mensola porta clavette  
Club wall holder

**Art. P00510/S00502/S00506**  
Coppia clavette in nylon,  
in legno a collo lungo e collo corto  
Wooden and plastic clubs



**Art. CS5**  
Corda salto  
per ritmica  
m. 3  
Jumping rope

pg.47



**Art. P01210**  
Nastro per ginnastica  
ritmica m. 6  
Rhythmic  
gym streamer



**Art. CS7**  
Corda salto  
per ritmica  
m. 3 piombata  
Weighted jumping  
rope



**Art. S01482**  
Tamburello  
completo  
di batacchio  
Rhythmic  
gym drum



pg.49

**Art. S01624**  
Specchio quadrettato  
con cornice  
in legno da fissare a parete  
misure cm.200x100  
Wall mirror with wooden frame



**Art. S01606**  
**Supporto per sbarra regolabile da fissare a parete**  
 Support for bar to be fixed on the wall

pg.48

pg.49



**Art. S01608**  
**Supporto per sbarra regolabile da fissare a terra**  
 Support for bar to be fixed on the floor



**Art. S00304**  
**Coppia ceppi Baumann in legno**  
 Pair of Baumann blocks in wood

pg.47



**Art. S00302**  
**Coppia appoggi Baumann in legno**  
 Pair of Baumann supports in wood

**Art. S01602**  
**Sbarra per danza in legno (pezzo unico fino a 4 metri)**  
 Wooden bar



**Art. 1156TE**  
**Supporto per sbarra regolabile da cm. 78 a cm. 140 in acciaio con base autoportante economica**  
 Cheap freestanding support for bar

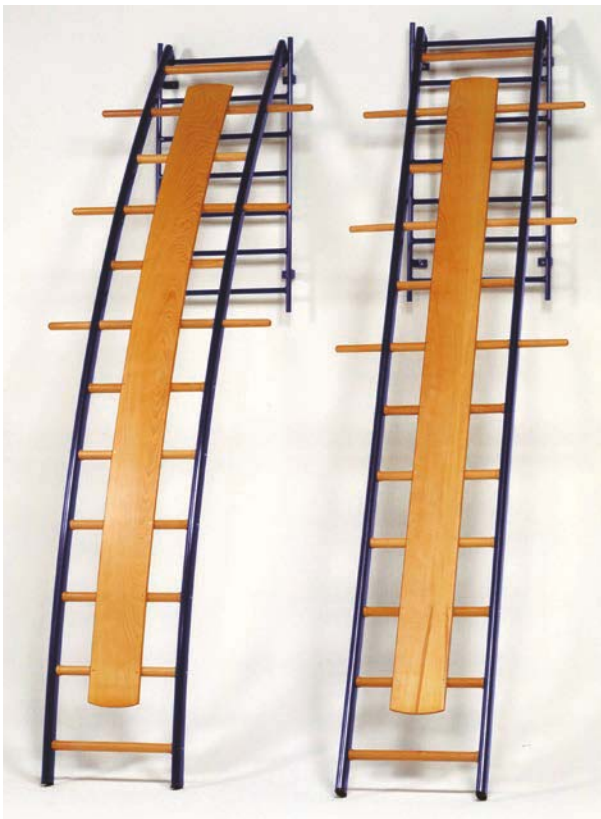

**Art. S01052 / S01054 / S01060 / S01062**  
**Scale ortopediche dritte o curve, a parete o trasportabili**  
 Orthopaedic ladders

pg.49



**Art. S00772/S00774**  
**Fune per salita**  
 lunghezza m. 5/m. 6  
 Climbing Rope  
 length 5 m./6 m.

pg.48



**Art. S00754 / S00756**  
**Palchi di salita**  
 (dettagli sul listino prezzi)  
 Climbing apparatus



**Art. S00792/2 - S00792/3**  
**Sistema di sospensione ed accostamento a parete per attrezzi da arrampicata (funi, pertiche, scale)**  
 Varnished steel frame for supporting and sliding climbing equipments to the wall, once not in use (ropes, poles and ladders)



pg.47

pg.49

**Art. S00056 / S00058 / S00052 / S00054**  
**Assi di equilibrio ad altezza fissa e graduabile**  
 Balance beams adjustable and fixed height



**Art. S00060 / S00064**  
**Trave di equilibrio in alluminio rivestito lunghezza mt.5 ad altezza regolabile (a norme F.I.G.) oppure ad altezza fissa**  
 Balance beam 5 meters adjustable height 50-120 cm. or fixed height



pg.48

**Art. S00204 / S00206 / S00208 / S00210**  
**Pedane elastiche con piano di battuta in legno, ricoperto in gomma, ricoperto in moquette o a doppio molleggio**  
 Springboards



**Art. S00104**  
**Cavallo regolamentare per volteggio rivestito in pelle sintetica altezza regolabile**  
 Vaulting buck adjustable height

pg.48



**Art. V1168**  
**Cavallina regolamentare rivestita in similpelle altezza regolabile da cm. 90 a cm.130**  
 Vaulting buck adjustable height



pg.48

**Art. S00218 / S00220**  
**Tappeto arrotolabile per pedana corpo libero in poliuretano e moquette, rotolo da m. 15/25 larghezza cm. 100/200**  
 Gymnastic moquette floor, roll m.15/25 long 100/200 cm. wide



pg.13

**Art. S00914/S00918/S00920**  
**Panche svedesi**  
 Swedish benches





**Art. S00252**  
**Sbarra orizzontale**  
**per volteggi regolabile in**  
**altezza, fissaggio**  
**a terra con tiranti**  
Vaulting bar adjustable height



**Art. S00160**  
**Parallela Scolastica a losanga**  
**ad altezza fissa, staggi in legno lamellare**  
Scholastic parallels fixed height

pg.48



**Art. S00156**  
**Parallela Asimmetrica Femminile in acciaio verniciato**  
**su basamento pesante, montanti graduabili,**  
**staggi in legno lamellare regolabili in altezza e larghezza**  
Asymmetrical bars adjustable height



**Art.S00152**  
**Parallela Maschile in acciaio verniciato**  
**su basamento pesante, montanti graduabili,**  
**staggi in legno lamellare**  
**regolabili in altezza e larghezza**  
Parallels bars adjustable height

## ATLETICA - Track & Field



**Art. PBS-SI**

**Blocco di partenza da allenamento**  
Polanik in acciaio zincato  
Starting Blocks Polanik in galvanized steel



**Art. BL01**

**Paio Blocchi di partenza in gomma per palestra**  
Pair of gym Starting Blocks in rubber for beginners



**Art. S02010/PPA38**

**Testimoni per staffetta**  
in PVC o omologati in alluminio  
PVC or aluminium relay baton



pg.49

**Art. TYVS**  
**Pettorali in tyvek**  
per gare atletica  
cm.21x16h  
personalizzabili  
Numbers for  
competitions



**Art. S02112**

**Megafono a transistor portatile**  
Handy megaphone



**Art. F601**

**Ostacolo per Atletica in ferro zincato**  
graduabile cm. 50-60-76,2  
Adjustable height  
hurdle in galvanized steel



**Art. S02126**

**Pistola a tamburo**  
per starter  
Starter's revolver gun



**Art. F602**

**Ostacolo per Atletica in ferro zincato**  
graduabile cm. 76,2-84-91,4  
Adjustable height  
hurdle in galvanized  
steel

**Art. S02072**  
**Ostacolo per Atletica in**  
alluminio anodizzato  
graduabile  
cm. 76,2-84-91,4-100-106,7  
**omologato I.A.A.F.**  
Adjustable height hurdle  
in anodized aluminium  
according to I.A.A.F. standards



**Art. S02064**

**Ostacolo per Atletica**  
in acciaio graduabile  
cm. 76,2-84-91,4-100-106,7  
Adjustable height hurdle  
in steel



**Art. VSH-222**

**Ostacolo per Atletica**  
Vinex olimpionico  
in ferro zincato  
**omologato I.A.A.F.**  
Adjustable height  
hurdle in galvanized  
steel according to  
I.A.A.F. standards



**Art. S02552**  
Coppia ritti salto in alto scolastici altezza cm.200  
Scholastic High Jump height 200 cm.



**Art. S02554**  
Coppia ritti salto in alto scolastici in acciaio zincato altezza cm.230  
Scholastic High Jump height 230 cm.



**Art. S02556**  
Coppia ritti salto in alto in acciaio zincato periscopici h. cm.250  
High Jump height 250 cm.



**Art. S02558**  
Coppia ritti salto in alto in acciaio zincato periscopici da competizione h. cm.260  
Competition High Jump height 260 cm.

(pg.52)



**Art. S02584**  
Piattaforma zincata di sostegno e sollevamento zona di caduta  
Galvanized steel support platform for landing mats

**Art. B2080/B2081**  
Zone di caduta salto in alto  
High Jump landing mats



**Art. S02566**  
Asta segnalimite per salto in alto in PTE  
High Jump crossbar with soft PTE cylinders

(pg.52)



**Art. PVS-CPTA**  
Coppia ritti per salto con l'asta in alluminio graduabili fino a cm. 650  
Pair of aluminium pole vault stands

**Art. B2077/B2078**  
Zone di caduta salto con l'asta  
Pole vault landing mats



**Art. S02570**  
Asticella segnalimite per salto in alto m. 4 in vetroresina  
High Jump fiberglass crossbar



**Art. TT09/ ... /VT15**  
Palle lancio  
in gomma Trial  
varie grammature  
Trial rubber throwing balls



**Art. VDL5/ ... /VDL72**  
Palle getto anelastiche  
in gomma Trial  
per indoor  
varie grammature  
Trial rubber shot balls  
for indoor



**Art. S02486/ ... /S02496**  
Palle getto in metallo verniciato  
tarate, varie grammature  
Metal shot balls



**Art. S02510**  
Pedana per lancio del peso  
in acciaio zincato  
Galvanized steel shot put throwing circle

pg.50

pg.51



**Art. S02512**  
FermapiEDE getto del peso  
in legno massiccio  
Shot put toe board in wood

**Art. STB-F100**  
FermapiEDE getto del peso  
in vetroresina I.A.A.F.  
Shot put toe board in fiberglass I.A.A.F.



**Art. CT6**  
Chiodo per scarpa  
in acciaio mm.6 modello  
Albero di Natale  
per corsa campestre  
Shoe steel stud 6 mm.

pg.49



**Art. P6 / P9**  
Chiodo per scarpa in acciaio  
mm.6 o mm.9 modello Pyramid  
Shoe steel stud 6 or 9 mm.

pg.51



**Art. P15020**  
Pedana Lancio in neoprene espanso  
per allenamento lancio del disco, giavellotto,  
peso, martello e salto in lungo  
Training toe board



**Art. LM0.5/ ... /LM5**  
Martelli sicuri supersoft  
in gomma Trial  
varie grammature  
Supersoft Trial hammers

pg.51



**Art. PM2/ ... /PM10**  
Martelli in acciaio da allenamento Polanik  
Polanik steel hammers



**Art. DSK1/ ... /DSK2**  
**Dischi in gomma Trial varie grammature**  
 Discus in rubber Trial



**Dischi Jet speciali per avviamento al lancio con peso distribuito sulla parte esterna per favorire la penetrazione nell'aria**  
 Special Jet discus with weight distributed mainly on the external perimeter in order to increase air penetration

**Art. JET03 / JET05 / JET1**  
**Dischi Jet in gomma Trial**  
 Kg. 0,3/0,5/1  
 Jet discus in rubber Trial

pg.49

pg.50



**Art. DT0.4/ ... /DT1**  
**Dischi Trial a 3 impugnature in gomma approvati I.A.A.F. per attività scolastica**  
 Trial discus approved by I.A.A.F. for school training

**Art. W4T/ ... /W10T**  
**Giavellotti Polanik in lega leggera con puntale in acciaio varie grammature**  
 Polanik Javelins in light alloy with steel edge in various weights



**Art. TPD075/ ... /TPD3**  
**Dischi in plastica bordati in acciaio Polanik**  
 Polanik discus in plastic-steel

**Art. CPD1/ ... /CPD2**  
**Dischi in plastica bordati in acciaio Polanik - omologati I.A.A.F.**  
 I.A.A.F. Polanik discus in plastic-steel



**Art. TRTJ**  
**Turbo Jav per avviamento al lancio**  
 Turbo Jav for throwing introduction

**Art. P15262**  
**Junior Jav in polietilene espanso**  
 cm. 88 gr. 50  
 Junior Jav

**Art. JAL-C400/ ... / JAL-C800**  
**Giavellotti Vinex in lega leggera con puntale in acciaio varie grammature**  
 Vinex Javelins in light alloy with steel edge in various weights



**Art. VMH**  
**Vortex per avviamento al lancio del giavellotto e per football americano**  
 Vortex for throwing introduction

pg.50



**Art. VMH.J**  
**Mini Vortex gr. 40 lunghezza cm. 17**  
 Mini Vortex

## PILATES



**Art. EVA.P**

**Mattoncino pilates in eva**  
cm.22,5x14,5x7,5h  
Block for pilates

pg.54



**Art. MPS30**

**Mattoncino pilates gonfiabile**  
Trial soft gr. 300 cm.12x24x3,5h  
Inflatable block for pilates

**Art. MPS50**

**Mattoncino pilates gonfiabile**  
Trial soft gr. 500 cm.11,3x24x5,5h  
Inflatable block for pilates



**Art. AHF-065/AHF-066**

**Sfera tonificante**  
verde kg.1 / viola kg.1,5  
Toning balls

**Art. AHF-045**

**Palla per yoga**  
ø cm.25  
Yoga ball



**Art. BA4**

**Palla tender per pilates**  
ø cm.20 - gr. 180  
super soffice e sicura  
Trial rubber tender ball  
for pilates



**Art. TR38**

**Toning ring**  
Toning ring

pg.54



**Art. AHF-001**

**Coppia sfere per massaggi**  
verde ø cm.7,5  
viola ø cm.9  
Massage balls



**Art. AHF-020**

**Power grip ball**  
Power grip ball

pg.20



**Art. B55 / B75**

**Relax Ball Trial**  
ø cm.5,5 / 7,5  
Relax Ball

**Art. 995025**

**Cilindro pieno**  
Foam roll

lunghezza cm. 90  
ø cm.15  
Foam roll not  
inflatable



**Art. FY9512**

**Fitball roller**  
gonfiabile  
diametro cm.18  
Fitball roller inflatable



pg.54

**Art. 995025BIS**

**Mezzo cilindro pieno Foam roll**  
lunghezza cm. 90  
altezza cm.7,5  
Half Foam roll  
not inflatable



**Art. AHF-044**

**Rullo massaggio**  
lunghezza cm.33  
ø cm.14  
Massaging roll



**Art. AHF-111**

**Rullo massaggio con impugnature**  
cm.53 ø cm.4,5  
Massaging roll

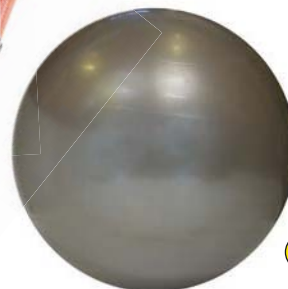

pg.22



**Art. TBSA/TBSB**

**Palla Boa autobilanciante in gomma Trial**  
oscilla ma torna al suo posto senza rotolare,  
stabile, ideale per correggere la postura,  
monocolore per adulti/bicolore per bambini  
Trial rubber Boa Ball swings but comes back  
to its original position - very good for postural  
therapy for adults and children

## PALLAPUGNO - BOCCE - TAMBURELLI



**Art. BA1**

**Air Ball Trial Ø cm. 12 gr. 100 morbida e rimbalzante (ideale anche per pallapugno)**  
Trial Air Ball



**Art. M05010**

**Pallapugno FIPAP diametro cm. 14**  
FIPAP pallapugno



**Art. GB100.03**

**Set 2 palette Front and Back con 2 palline**  
Front and Back set



pg.54

**Art. ST14**

**Palla Canguro Ø cm. 45**  
Trial Cangaroo Ball



**Art. ST15**

**Palla Canguro Ø cm. 55**  
Trial Cangaroo Ball



**Art. ST16**

**Palla Canguro Ø cm. 65**  
Trial Cangaroo Ball



**Art. ASKB**

**Set 8 bocce in legno laccato diametro mm. 100 con pallino diametro mm. 40**  
Set 8 wooden bowls

pg.54

**Art. BTST12**  
**Set 6+6 bocce supersoft con pallino e borsa**  
Set of 12 supersoft bowls with bag



**Art. P18110**  
**Tamburello indoor diametro cm. 26 (fino a 13 anni) omologato FIPT**  
FIPT indoor tamburello Ø cm. 26



**Art. P18111**

**Tamburello indoor diametro cm. 28 omologato FIPT**  
FIPT indoor tamburello Ø cm. 28



**Art. P18112**

**Pallina per tamburello depressurizzata indoor diametro cm. 6,5 gr. 40**  
Tamburello indoor depressurized ball



**Art. S00552 / S00556**  
**Fune per tiro alla fune lunghezza m. 15 / m. 25 con indicazioni colorate**  
Rope for tug of war length 15 / 25 meters

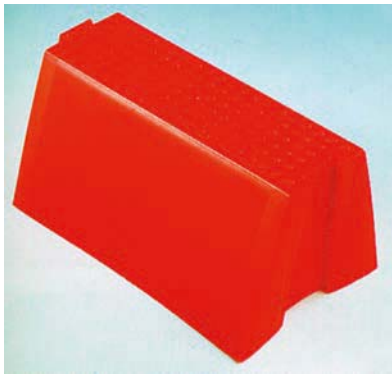

**Art. I-059**  
Set 10 mattoncini dritti  
cm. 25x16x13h  
Set of 10 straight bricks

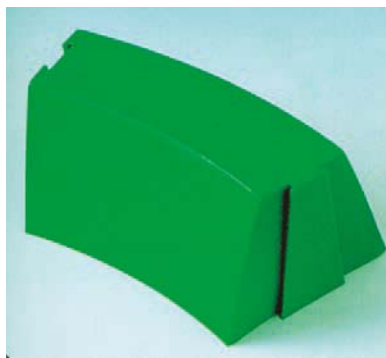

**Art. I-060**  
Set 10 mattoncini curvi  
cm. 22x16x13h  
Set of 10 curved bricks

pg.54

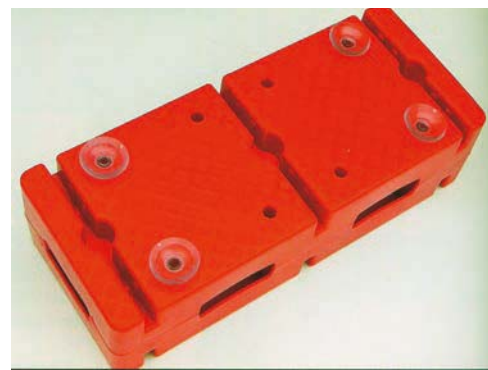

**Art. I-098**  
Blocco percorso  
cm. 30x15x10h  
Block for route



**Art. PCAD**  
Paracadute Ø cm. 300  
Parachute



**Art. I-061**  
Percorso equilibrio composto da  
5 assi + 6 mattoncini + 24 ventose  
Balance route



**Art. S00794** pg.48  
Pannello per arrampicata in legno  
agganciabile a spalliera o quadro  
svedese  
Climbing board



**Art. DDB12**  
Bussola per  
orienteeing  
in plastica  
trasparente  
con laccio  
Compass

pg.54



**PALLA  
AVVELENATA  
Dodgeball**



**Art. TDB16**  
Palla per Dodgeball diametro cm. 16  
peso gr. 210 colore arancio fluo  
Dodgeball Ø cm. 16

pg.54



**Art. TDB20**  
Palla per Dodgeball diametro cm. 20  
peso gr. 230 colore giallo fluo  
Dodgeball Ø cm. 20



## SKATEBOARD - PATTINI - MONOPATTINI - FRISBEE



**Art. SKM2401** Skateboard Junior cm.61



**Art. SKM3103** Skateboard Senior cm.77,5



**Art. F4-400**  
Casco Skate  
taglie S, M, L  
Skate helmet

pg.53

**New!**



**Art. GDA20**  
Bersaglio elettronico  
per il gioco delle  
freccette (incluse 6  
freccette e 40 punte di  
ricambio)  
Darts electronic target  
(including 6 darts and 40  
spare tips)



**Art. 681171**  
Set 3 protezioni Junior

**Art. 132171**  
Set 3 protezioni Senior  
(misura S, M, L)  
Junior and Senior protections



**Art. SKJP-G**  
Pattino in line  
allungabile Junior  
taglie: 30/33 - 34/37 - 38/41  
In line skate adjustable size



**Art. ML9200**  
Monopattino  
pieghevole,  
ruote Ø mm. 200  
peso massimo  
utilizzatore kg. 100  
Scooter

**Art. ML8125**  
Monopattino  
pieghevole,  
ruote Ø mm. 125  
peso massimo  
utilizzatore kg. 50  
Junior Scooter

**New!**



**Art. AHF-084**  
Bastoncini  
Nordic  
Walking  
con altezza  
regolabile da  
65 a 135 cm.  
(3 tipi di punte  
incluse)  
Nordic Walking  
sticks with adjustable  
height from  
65 to 135 cm.  
(3 types of tips included)



**Art. FRPPR**  
Frisbee  
diametro  
cm. 27,5  
gr.160  
Frisbee

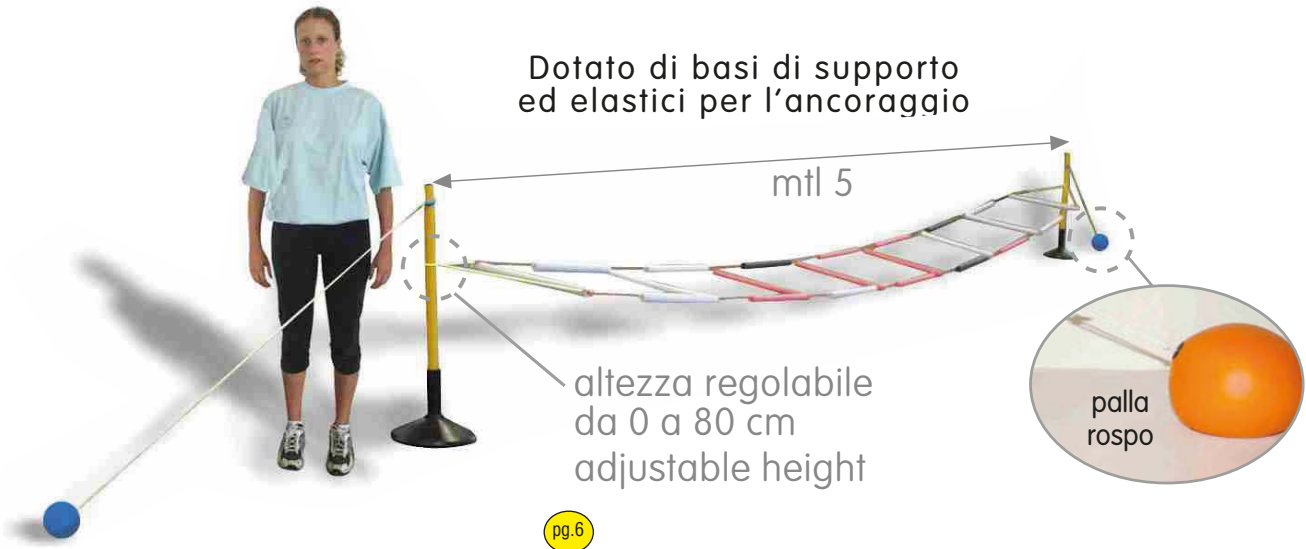

**Art. T10076**  
**Coordinatore di Frequenza / Calcio Tennis**  
**lunghezza m. 5 utilizzabile anche su superfici sintetiche**  
**attrezzo sicuro, privo di picchetti in metallo**  
 Speed Ladder / Soccer Tennis Kit  
 length 5 meters - also for indoor or artificial grass  
 safe without any metal spikes

**Ideale per i bambini delle scuole calcio**  
**best for soccer school kids**

