



CATALOGO CIAK INCISORIA 2024



Asso di Coppe

◀ VESTE E PREMIA LO SPORT ▶

Richiedi un preventivo **GRATUITO** per portarti a conoscenza dello **SCONTO RISERVATO**
Per le vostre esigenze diverse vi preghiamo di visitare i siti
www.assodicoppe.it - info@assodicoppe.it



Indice

Targhe da porta: modelli personalizzati	p. 4
Targhe da esterno: modelli personalizzati	p. 6
Targhe da porta e da esterno	p. 23
Telai portatarghe e fuoriporta	p. 45
Accessori	p. 51
Scritte, numeri e loghi	p. 59
Braille	p. 65
Alberghiera	p. 69
Targhe e lavorazioni per industria	p. 85
Timbri	p. 93
Pulsantiere e buche lettere	p. 97
Premiazioni	p. 111

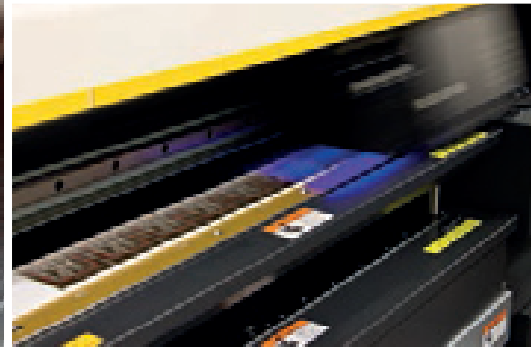
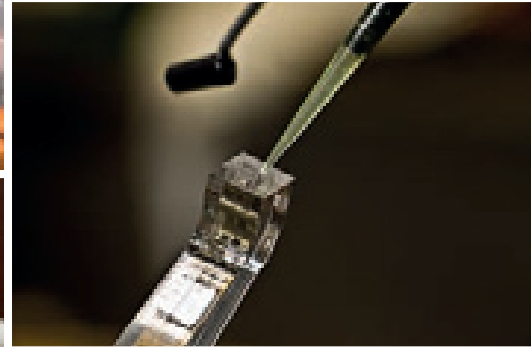
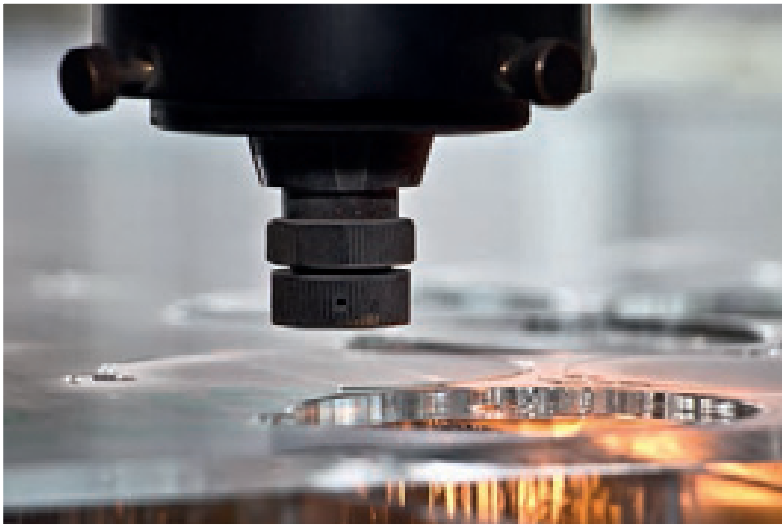
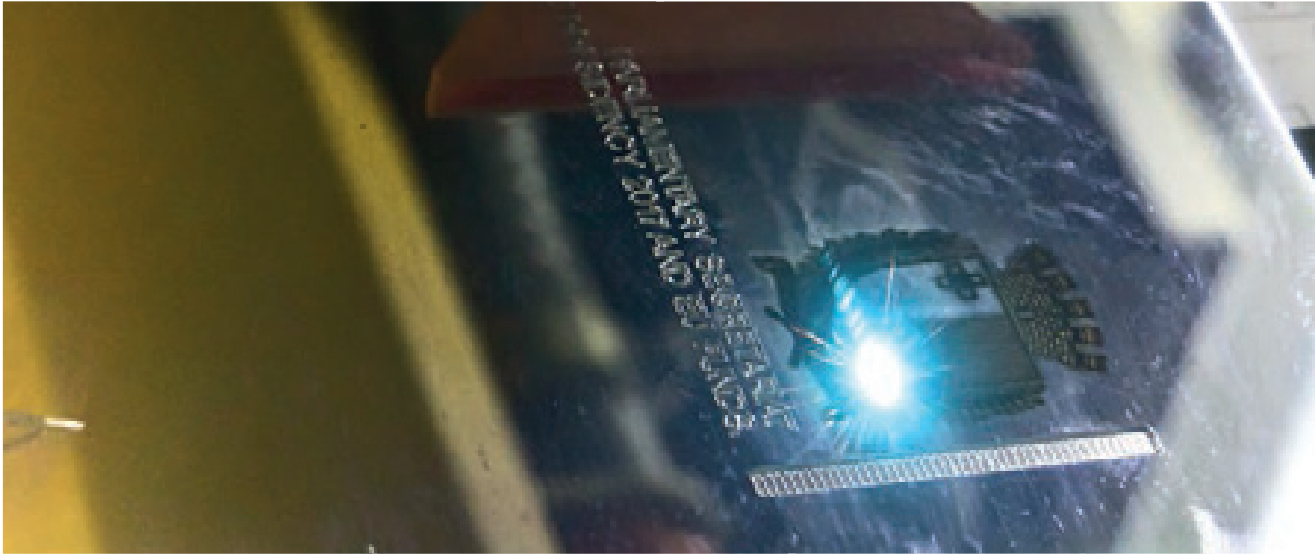
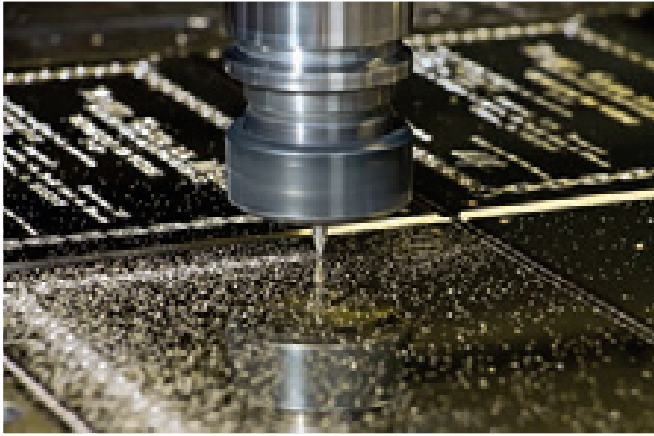

Passion quality design

La nostra azienda, presente nel mercato da 25 anni, si è sempre distinta per l'alto livello delle lavorazioni e per l'unicità dei modelli proposti.

Nel corso di questi anni abbiamo sempre inseguito l'innovazione tecnologica per stare al passo con le richieste del mercato e per soddisfare al meglio la nostra clientela. Questa continua crescita ci ha permesso di essere presenti in svariati settori: incisoria, premiazione, arredamento, alberghiero, industria, edilizia, cantieristica navale e altri ancora.

Gli ultimi macchinari acquistati, per migliorare la nostra produzione, sono la stampa digitale, la marcatura laser fibra e co2, il taglio laser e l'incisione chimica che, assieme a quelli già presenti, ci consentono di realizzare i nostri prodotti in vari materiali: ottone, alluminio, acciaio, rame, bronzo, metacrilato trasparente e colorato, pvc, legno e pellame.

In tutti questi anni di esperienza e sviluppo gli obiettivi finali della nostra azienda rimangono, sempre e comunque, la qualità della nostra produzione e la soddisfazione del cliente.

Targhe da porta: modelli personalizzati



es. 201

Targa da porta in ottone satinato con taglio lucido mm 145 x 65 Sp. 3, incisa e smaltata



es. 202

Ovale da porta in ottone lucido bombato mm 145 x 75, inciso e smaltato



es. 203

Targa sagomata da porta in ottone satinato con bordo lucido mm 145 x 55 Sp. 3, incisa e smaltata

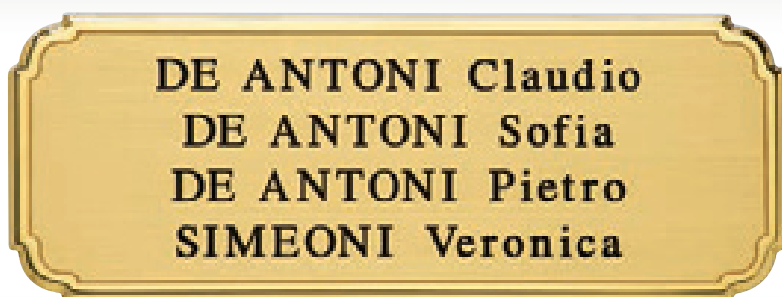

es. 204

Targa sagomata da porta in ottone satinato con bordo lucido mm 145 x 55 Sp. 2, incisa e smaltata



es. 205

Ovale da porta in ottone satinato con bordo lucido mm 145 x 75 Sp. 3, inciso e smaltato

Targhe da porta: modelli personalizzati

es. 206

Targa da porta in alluminio satinato verniciato con taglio lucido mm 145 x 65 Sp. 2, incisa e smaltata



es. 207 ORO - es. 207 ARGENTO

Ovali da porta in alluminio anodizzato oro e argento con taglio lucido mm 145 x 75 Sp. 2, incisi e smaltati



es. 208

Targa sagomata da porta in alluminio satinato verniciato con bordo lucido mm 145 x 55 Sp. 2, incisa e smaltata



es. 209

Targa sagomata da porta in alluminio satinato verniciato con bordo lucido mm 145 x 55 Sp. 2, incisa e smaltata



es. 210

Ovale da porta in alluminio satinato verniciato con bordo lucido mm 145 x 75 Sp. 2, inciso e smaltato



Targhe da esterno: modelli personalizzati



es. 211

Targa in ottone brunito con bordo lucido
mm 300 x 200 Sp. 2, incisa color ottone



es. 212

Targa in ottone satinato
mm 300 x 200 Sp. 2, incisa e smaltata



es. 213

Ovale in ottone lucido bombato
mm 300 x 175, inciso e smaltato



es. 214

Targa in metacrilato trasparente
mm 300 x 200 Sp. 10, incisa e smaltata,
applicata su base in ottone satinato con
bordo lucido Sp. 2 mm.
Completa di distanziali e borchie

es. 215

Targa sciolata in ottone satinato con fianchi lucidi mm 300 x 200 Sp. 2, incisa e smaltata



es. 216

Targa in ottone satinato mm 220 x 310 Sp. 3, con soggetto lucido e scritte incise senza smalti

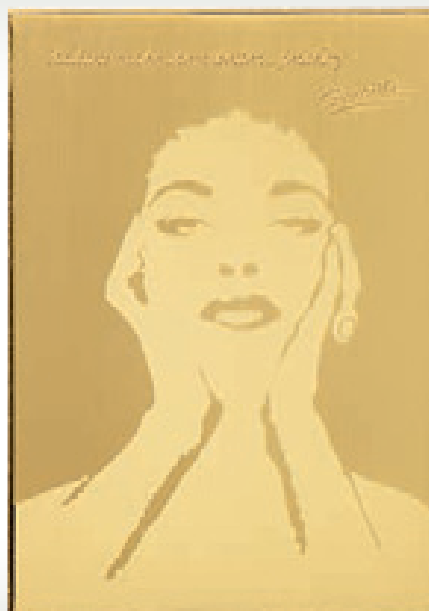

es. 217

Targa in ottone satinato mm 300 x 300 Sp. 3, con incisione sabbiata



Targhe da esterno: modelli personalizzati



es. 218

Targa in alluminio satinato verniciato con taglio lucido mm 300 x 200 Sp. 2, incisa e smaltata



es. 219

Ovale in alluminio satinato verniciato con bordo lucido mm 300 x 180 Sp. 2, inciso e smaltato



es. 220

Targa in alluminio satinato verniciato con bordo lucido mm 300 x 200 Sp. 2, incisa e smaltata



es. 221

Targa in alluminio satinato verniciato con bordo lucido mm 300 x 200 Sp. 2, incisa e smaltata con applicato logo scontornato in ottone inciso e smaltato. Vedi dettaglio pag. 22

Targhe da esterno: modelli personalizzati

es. 222

Piastra rotonda in alluminio anodizzato champagne ø mm 135 Sp. 20, con fresatura a disegno, bassofondo per inserimento disco in metacrilato sabbato inciso e smaltato



es. 223

Piastra in alluminio anodizzato champagne mm 200 x 250 Sp. 20, con fresatura a disegno, bassofondo per inserimento targa in metacrilato sabbato incisa e smaltata



es. 224

Targa in alluminio mm 200 x 200 x 5, con incisione soggetto e verniciatura bianca



es. 225

Targa in metacrilato trasparente mm 250 x 300 Sp. 10 con angoli arrotondati, incisa e smaltata, con applicato logo in alluminio sabbato con particolare a rilievo lucido e lettere smaltate



Targhe da esterno: modelli personalizzati



es. 226

Targa in acciaio satinato, mm 400 x 250 Sp. 2, con applicate 2 fasce in acciaio lucido, scritta in ottone cromato e cerchi in metacrilato sabbatiato. Vedi dettaglio pag. 22

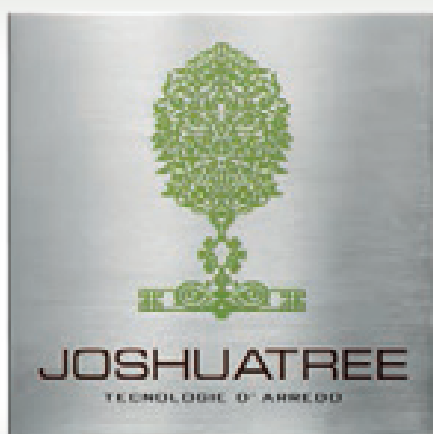

es. 227

Targa sciolata a 90° in acciaio satinato con fianchi lucidi mm 320 x 320, incisa e smaltata



es. 228

Targa sciolata in acciaio satinato con fianchi lucidi mm 500 x 210, con applicato logo e scritte scontornati in ottone cromato. Vedi dettaglio pag. 22



es. 229

Disco acciaio lucido ø 200 mm Sp. 2, con grafica traforata, applicato su base in acciaio lucido ø 200 mm, distanziato 10 mm

es. 230

Targa in ottone mm 400 x 400 Sp. 2, verniciata verde inglese, con applicata cornicetta e scritta scontornata in ottone lucido Sp. 3 mm e fiore scontornato in ottone lucido, inciso e smaltato



es. 231

Targa metacrilato nero pasta piena mm 510 x 300 Sp. 15, incisa e smaltata oro, con applicati cornice, scritta e soggetto in ottone cromato



es. 232

Targa in metacrilato nero pasta piena mm 400 x 400 x Sp. 15, incisa e smaltata color oro, con applicati logo e scritta in ottone lucido/brunito



Targhe da esterno: modelli personalizzati



es. 233

Targa in metacrilato trasparente mm 350 x 250 Sp. 10, incisa e smaltata, applicata e distanziata su base in alluminio anodizzato argento Sp. 2 mm



es. 234

Targa in metacrilato mm 350 x 350 Sp. 10, fondo sabbato e bordo trasparente, incisa e smaltata



es. 235

Targa in acciaio mm 350 x 350 Sp. 2, con fondo sabbato e grafica lucida



es. 236

Targa in metacrilato trasparente mm 300 x 300 Sp. 2, incisa e smaltata

Targhe da esterno: modelli personalizzati

es. 237

Targa in fusione di bronzo con ossidazione naturale mm 380 x 245 Sp. 20, con logo e scritte a rilievo satinato. Vedi dettaglio pag. 21



es. 238

Targa in fusione di ottone brunito mm 200 x 120 Sp. 5



es. 239

Targa in ottone brunito mm 300 x 300 Sp. 2, con traforatura soggetto e particolari piegati. Applicata e distanziata su base in metacrilato colorato Sp. 3 mm



es. 240

Targa in ottone brunito mm 250 x 165 Sp. 5, con logo traforato, fascia e scritte lucide



Targhe da esterno: modelli personalizzati



es. 241

Targa in ottone con fondo inciso brunito scuro con verniciatura opaca mm 350 x 230 Sp. 5, con cornice, scritte e soggetto a rilievo satinato



es. 242

Targa in ottone mm 240 x 180 Sp. 5 con fondo inciso brunito bocciardato, bordi, logo e testo a rilievo satinato, soggetto "palazzo" a rilievo lucido con particolari laserati. Vedi dettaglio pag. 21



es. 243

Targa in ottone mm 300 x 200 Sp. 8, fondo inciso e brunito scuro, cornice, scritte e logo a rilievo satinato



es. 244

Targa in ottone mm 300 x 200 Sp. 5, fondo inciso e brunito scuro, cornice e scritte a rilievo lucido con applicato soggetto Cristo in fusione. Vedi dettaglio pag. 21

es. 245

Targa in ottone mm 310 x 210 Sp. 3, realizzata mediante fresatura tridimensionale su grafica in scala di grigi, fondo brunito con rilievi schiariti



es. 246

Targa in alluminio naturale mm 200 x 150 Sp. 3, realizzata mediante fresatura tridimensionale su grafica in scala di grigi, fondo brunito con rilievi schiariti



es. 247

Sagoma scontomata in ottone brunito mm 195 x 195 Sp. 3, realizzata mediante fresatura tridimensionale su grafica in scala di grigi con rilievi lucidi



Targhe da esterno: modelli personalizzati



es. 248

Targa in ottone satinato con bordo lucido
mm 300 x 200 Sp. 2, con logo e scritta
"Città di Venezia" incisi e smaltati,
stampa digitale della fotografia e del testo

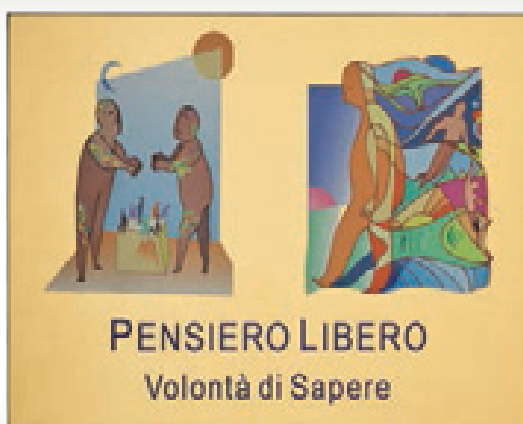

es. 249

Targa in alluminio anodizzato oro
mm 300 x 200 Sp. 2, con stampa digitale



es. 250

Ovale in ottone satinato con bordo lucido
mm 300 x 200 Sp. 2, con stampa digitale

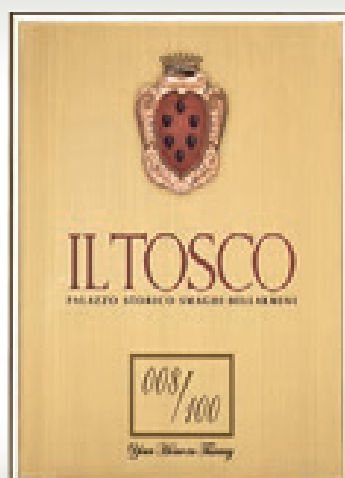

es. 251

Targa in ottone satinato con bordo lucido
mm 200 x 270 Sp. 2, con stampa digitale

es. 252

Ovale in alluminio preverniciato bianco
mm 300 x 180 Sp. 2, con stampa digitale



es. 253

Targa in alluminio preverniciato bianco
mm 350 x 200 Sp. 2, con stampa digitale



es. 254

Ovale in alluminio anodizzato argento
con taglio lucido mm 145 x 75 Sp. 2,
con stampa digitale



es. 255

Targa in metacrilato trasparente
mm 200 x 280 Sp. 10,
con stampa digitale sul retro



Targhe da esterno: modelli personalizzati



es. 256

Targa in alluminio anodizzato argento
mm 310 x 210 Sp. 2, con stampa digitale



es. 257

Targa in metacrilato acidato
mm 310 x 210 Sp. 5, con stampa digitale

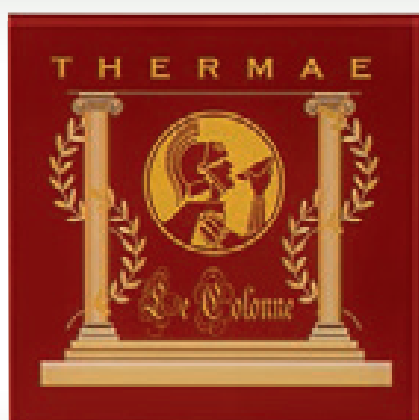

es. 258

Targa in metacrilato trasparente
mm 225 x 225 Sp. 5, con stampa digitale
e fondo verniciato sul retro



es. 259

Targa in metacrilato trasparente
mm 300 x 200 Sp. 5, con stampa digitale
e fondo verniciato bianco sul retro.
Finestra per scorrevole in metacrilato
stampata in digitale

Targhe da esterno: modelli personalizzati

es. 260

Base in metacrilato trasparente
mm 310 x 210 Sp. 10, con applicata targa
in alluminio mm 260 x 160 Sp. 2
con stampa digitale



es. 261

Targa in metacrilato trasparente
mm 400 x 300 Sp. 10,
con stampa digitale sul retro



es. 262

Targa in metacrilato trasparente
mm 550 x 250 Sp. 10,
con stampa digitale sul retro



Targhe da esterno: modelli personalizzati

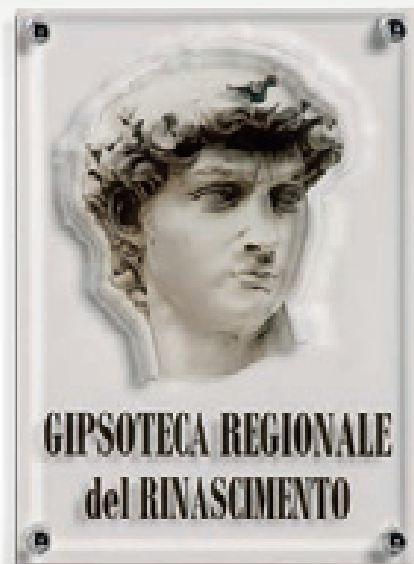

es. 263

Targa in metacrilato trasparente mm 250 x 350 Sp. 15, con traforatura del contorno del soggetto e stampa digitale sul retro

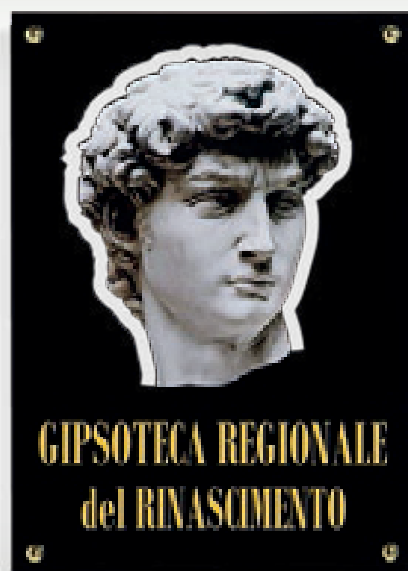

es. 264

Targa in metacrilato nero pasta piena mm 250 x 350 Sp. 20, con traforatura del contorno del soggetto e stampa digitale



es. 265

Targa in acciaio corten mm 300 x 300 Sp. 3, con 2 fianchi laterali verticali piegati mm 40, incisa e smaltata, con stella traforata e particolare applicato in acciaio verniciato arancione



Dettaglio dell'es. 244 di pag. 14



Dettaglio dell'es. 242 di pag. 14



Dettaglio dell'es. 237 di pag. 13

Particolari di lavorazione



Dettaglio dell'es. 221 di pag. 8



Dettaglio dell'es. 226 di pag. 10



Dettaglio dell'es. 228 di pag. 10

Targhe da porta e da esterno



Targhe da porta



DL - Sagomata ottone bordo lucido

DL1 - 145 x 55 mm Sp. 3 mm

DL2 - 125 x 45 mm Sp. 3 mm



AL - Sagomata ottone bordo lucido

AL1 - 145 x 55 mm Sp. 3 mm

AL2 - 125 x 45 mm Sp. 3 mm



CL - Sagomata ottone bordo lucido

CL1 - 145 x 55 mm Sp. 3 mm

CL2 - 125 x 45 mm Sp. 3 mm



FL - Sagomata ottone bordo lucido

FL1 - 145 x 55 mm Sp. 3 mm

FL2 - 125 x 45 mm Sp. 3 mm

DLS - Sagomata ottone bordo lucido

DLS1 - 145 x 55 mm Sp. 1,5 mm

DLS2 - 125 x 45 mm Sp. 1,5 mm



ALS - Sagomata ottone bordo lucido

ALS1 - 145 x 55 mm Sp. 1,5 mm

ALS2 - 125 x 45 mm Sp. 1,5 mm



CLS - Sagomata ottone bordo lucido

CLS1 - 145 x 55 mm Sp. 1,5 mm

CLS2 - 125 x 45 mm Sp. 1,5 mm



FLS - Sagomata ottone bordo lucido

FLS1 - 145 x 55 mm Sp. 1,5 mm

FLS2 - 125 x 45 mm Sp. 1,5 mm



Targhe da porta



FT - Sagomata ottone satinato taglio lucido

FT1 - 145 x 55 mm Sp. 3 mm

FT2 - 125 x 45 mm Sp. 3 mm

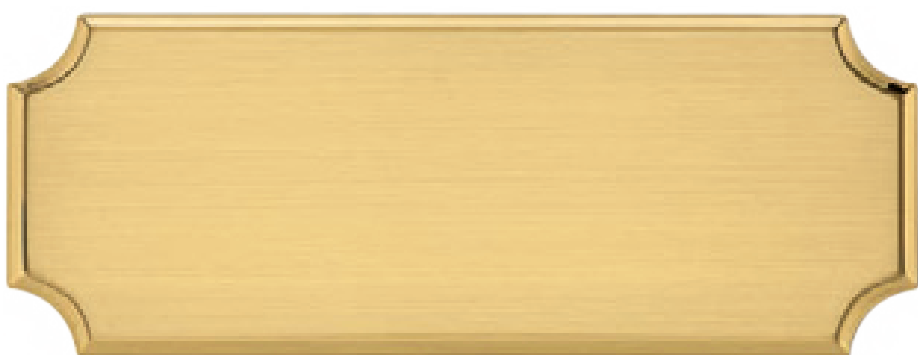

DT - Sagomata ottone satinato taglio lucido

DT1 - 145 x 55 mm Sp. 3 mm

DT2 - 125 x 45 mm Sp. 3 mm

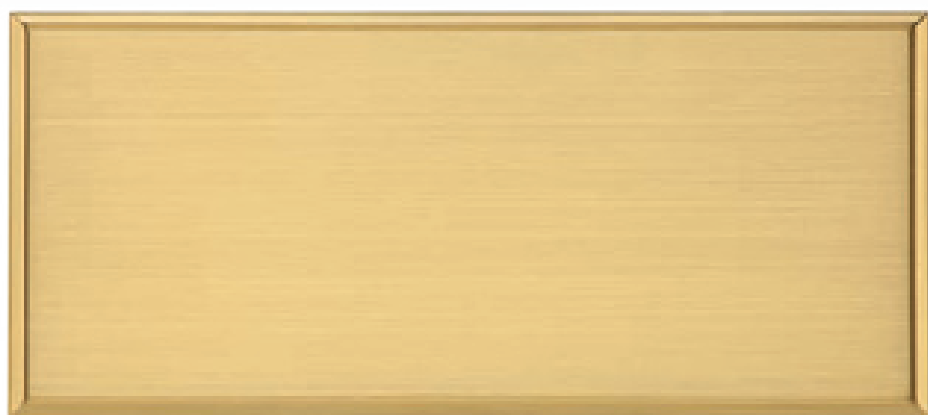

RT - Rettangolare ottone satinato taglio lucido

RT1 - 145 x 65 mm Sp. 3 mm

RT2 - 125 x 55 mm Sp. 3 mm

OL - Ovale ottone satinato bordo lucido

OL1 - 145 x 75 mm Sp. 3 mm

OL2 - 125 x 60 mm Sp. 3 mm



OS - Ovale ottone satinato taglio lucido

OS1 - 145 x 75 mm Sp. 3 mm

OS2 - 125 x 60 mm Sp. 3 mm



OLL - Ovale ottone lucido

OLL1 - 145 x 75 mm Sp. 2 mm

OLL2 - 125 x 60 mm Sp. 2 mm



Targhe da porta



OB - Ovale ottone lucido bombato

OB5 - 145 x 75 mm

OB6 - 120 x 60 mm

OB7 - 90 x 40 mm



OVS - Ovale ottone satinato

OVS5 - 145 x 75 mm Sp. 2 mm

OVS6 - 125 x 60 mm Sp. 2 mm

OVS7 - 100 x 50 mm Sp. 2 mm



OLS - Ovale ottone satinato bordo lucido

OLS1 - 145 x 75 mm Sp. 1,5 mm

OLS2 - 125 x 60 mm Sp. 1,5 mm

OLS3 - 100 x 50 mm Sp. 1,5 mm

OLS4 - 80 x 45 mm Sp. 1,5 mm

OLS5 - 60 x 35 mm Sp. 1 mm

OLS6 - 50 x 27 mm Sp. 1 mm

AO - Ovale alluminio satinato
bordo lucido verniciato

- AO1** - 145 x 75 mm Sp. 2 mm
- AO2** - 125 x 60 mm Sp. 2 mm
- AO3** - 100 x 50 mm Sp. 2 mm
- AO4** - 80 x 45 mm Sp. 2 mm



AOL - Ovale alluminio lucido verniciato

- AOL1** - 145 x 75 mm Sp. 2 mm
- AOL2** - 125 x 60 mm Sp. 2 mm
- AOL3** - 100 x 50 mm Sp. 2 mm
- AOL4** - 80 x 45 mm Sp. 2 mm



ATA - Ovale alluminio anodizzato argento
taglio lucido

- ATA1** - 145 x 75 mm Sp. 2 mm
- ATA2** - 125 x 60 mm Sp. 2 mm
- ATA3** - 100 x 50 mm Sp. 2 mm
- ATA4** - 80 x 45 mm Sp. 2 mm

ATO - Ovale alluminio anodizzato oro
taglio lucido

- ATO1** - 145 x 75 mm Sp. 2 mm
- ATO2** - 125 x 60 mm Sp. 2 mm
- ATO3** - 100 x 50 mm Sp. 2 mm
- ATO4** - 80 x 45 mm Sp. 2 mm



Targhe da porta



ADL - Sagomata alluminio satinato
bordo lucido verniciato

ADL1 - 145 x 55 mm Sp. 2 mm

ADL2 - 125 x 45 mm Sp. 2 mm



AML - Sagomata alluminio satinato
bordo lucido verniciato

AML1 - 145 x 55 mm Sp. 2 mm

AML2 - 125 x 45 mm Sp. 2 mm



ACL - Sagomata alluminio satinato
bordo lucido verniciato

ACL1 - 145 x 55 mm Sp. 2 mm

ACL2 - 125 x 45 mm Sp. 2 mm

Ovali ottone grandi formati

OVS - Ovale ottone satinato

- OVS1** - 400 x 240 mm Sp. 2 mm
- OVS2** - 300 x 180 mm Sp. 2 mm
- OVS3** - 250 x 150 mm Sp. 2 mm
- OVS4** - 200 x 110 mm Sp. 2 mm



OVL - Ovale ottone satinato bordo lucido

- OVL1** - 400 x 240 mm Sp. 3 mm
- OVL2** - 300 x 180 mm Sp. 3 mm
- OVL3** - 250 x 150 mm Sp. 3 mm
- OVL4** - 200 x 110 mm Sp. 3 mm



OB - Ovale ottone lucido bombato

- OB1** - 600 x 450 mm
- OB2** - 450 x 250 mm
- OB3** - 300 x 180 mm
- OB4** - 200 x 120 mm



Ovali alluminio grandi formati



AO - Ovale alluminio satinato bordo lucido

- AO3** - 400 x 240 mm Sp. 2 mm
- AO4** - 300 x 180 mm Sp. 2 mm
- AO5** - 250 x 150 mm Sp. 2 mm
- AO6** - 200 x 110 mm Sp. 2 mm



ATA - Ovale alluminio anodizzato argento

- ATA3** - 400 x 240 mm Sp. 2 mm
- ATA4** - 300 x 180 mm Sp. 2 mm
- ATA5** - 250 x 150 mm Sp. 2 mm
- ATA6** - 200 x 110 mm Sp. 2 mm

ATO - Ovale alluminio anodizzato oro

- ATO3** - 400 x 240 mm Sp. 2 mm
- ATO4** - 300 x 180 mm Sp. 2 mm
- ATO5** - 250 x 150 mm Sp. 2 mm
- ATO6** - 200 x 110 mm Sp. 2 mm



AOB - Ovale alluminio preverniciato bianco

- AOB3** - 400 x 240 mm Sp. 2 mm
- AOB4** - 300 x 180 mm Sp. 2 mm
- AOB5** - 250 x 150 mm Sp. 2 mm
- AOB6** - 200 x 110 mm Sp. 2 mm

TO - Targa ottone satinato bisellato

TO 5040	- 500 x 400 mm	Sp. 2 mm
TO 4030	- 400 x 300 mm	Sp. 2 mm
TO 3020	- 300 x 200 mm	Sp. 2 mm
TO 2015	- 200 x 150 mm	Sp. 2 mm
TO 2010	- 200 x 100 mm	Sp. 2 mm
TO 176	- 170 x 60 mm	Sp. 1,5 mm
TO 165	- 160 x 50 mm	Sp. 1,5 mm
TO 124	- 120 x 40 mm	Sp. 1,5 mm
TO 83	- 80 x 30 mm	Sp. 1,5 mm
TO 62	- 60 x 20 mm	Sp. 1,5 mm



TOL - Targa ottone lucido bisellato

TOL 4030	- 400 x 300 mm	Sp. 2 mm
TOL 3020	- 300 x 200 mm	Sp. 2 mm
TOL 2015	- 200 x 150 mm	Sp. 2 mm
TOL 83	- 80 x 30 mm	Sp. 1,5 mm
TOL 62	- 60 x 20 mm	Sp. 1,5 mm



TL - Targa ottone satinato bisello lucido

TL1	- 400 x 300 mm	Sp. 2 mm
TL2	- 300 x 200 mm	Sp. 2 mm
TL3	- 200 x 150 mm	Sp. 2 mm



Targhe ottone



TU - Targa ottone satinato bordo lucido

- TU1** - 400 x 300 mm Sp. 2 mm
- TU2** - 400 x 200 mm Sp. 2 mm
- TU3** - 300 x 200 mm Sp. 2 mm
- TU4** - 200 x 150 mm Sp. 2 mm
- TU5** - 200 x 100 mm Sp. 2 mm



BL - Targa ottone satinato bordo lucido

- BL1** - 400 x 300 mm Sp. 2 mm
- BL2** - 400 x 200 mm Sp. 2 mm
- BL3** - 300 x 200 mm Sp. 2 mm
- BL4** - 200 x 150 mm Sp. 2 mm
- BL5** - 200 x 100 mm Sp. 2 mm

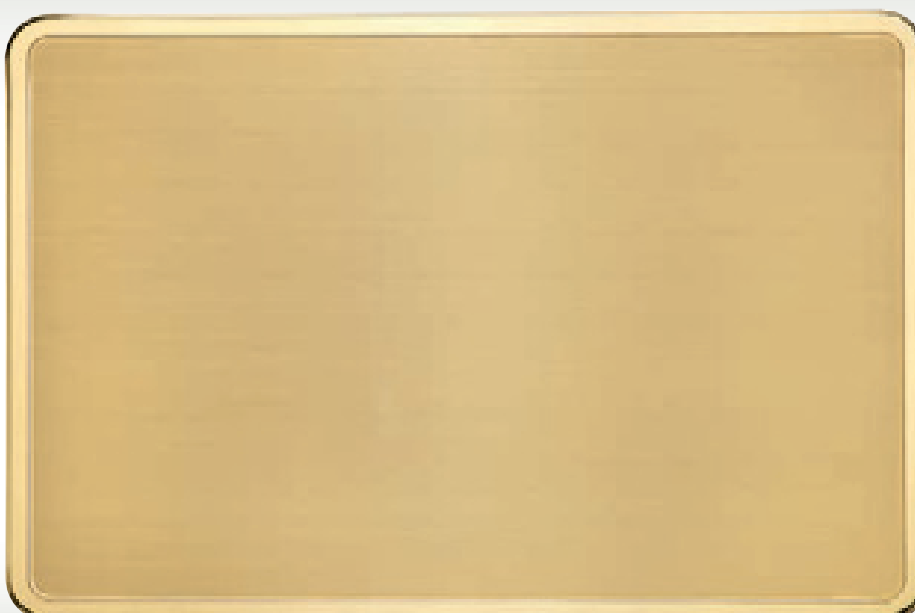

RBL - Targa ottone satinato bordo lucido con angoli arrotondati

- RBL1** - 400 x 300 mm Sp. 2 mm
- RBL2** - 400 x 200 mm Sp. 2 mm
- RBL3** - 300 x 200 mm Sp. 2 mm
- RBL4** - 200 x 150 mm Sp. 2 mm
- RBL5** - 200 x 100 mm Sp. 2 mm

TB - Targa ottone brunito

- TB1** - 400 x 300 mm Sp. 2 mm
- TB2** - 400 x 200 mm Sp. 2 mm
- TB3** - 300 x 200 mm Sp. 2 mm
- TB4** - 200 x 150 mm Sp. 2 mm
- TB5** - 200 x 100 mm Sp. 2 mm



TBU - Targa ottone brunito bordo lucido

- TBU1** - 400 x 300 mm Sp. 2 mm
- TBU2** - 400 x 200 mm Sp. 2 mm
- TBU3** - 300 x 200 mm Sp. 2 mm
- TBU4** - 200 x 150 mm Sp. 2 mm
- TBU5** - 200 x 100 mm Sp. 2 mm



TBL - Targa ottone brunito bordo lucido

- TBL1** - 400 x 300 mm Sp. 2 mm
- TBL2** - 400 x 200 mm Sp. 2 mm
- TBL3** - 300 x 200 mm Sp. 2 mm
- TBL4** - 200 x 150 mm Sp. 2 mm
- TBL5** - 200 x 100 mm Sp. 2 mm



Targhe scatolate ottone e alluminio



SC - Scatolata ottone satinato fianchi lucidi

- SC1** - 600 x 400 mm
- SC2** - 400 x 300 mm
- SC3** - 400 x 200 mm
- SC4** - 350 x 250 mm
- SC5** - 300 x 200 mm
- SC6** - 200 x 150 mm
- SC7** - 200 x 100 mm



ASC - Scatolata alluminio satinato verniciato fianchi lucidi

- ASC1** - 600 x 400 mm
- ASC2** - 400 x 300 mm
- ASC3** - 400 x 200 mm
- ASC4** - 350 x 250 mm
- ASC5** - 300 x 200 mm
- ASC6** - 200 x 150 mm
- ASC7** - 200 x 100 mm

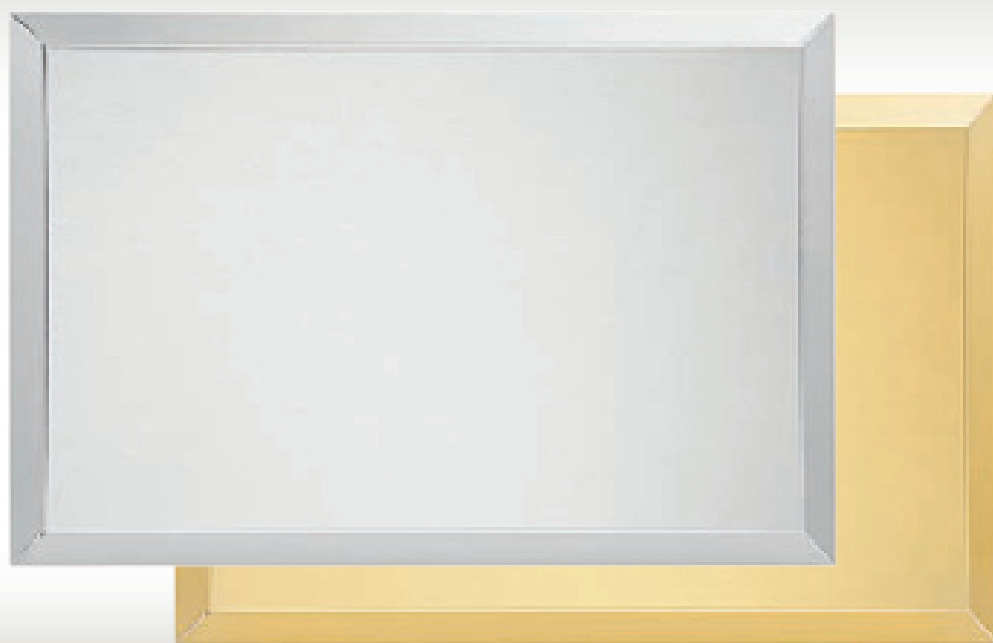

ASCA - Scatolata alluminio da lastra anodizzata argento

- ASCA1** - 600 x 400 mm
- ASCA2** - 400 x 300 mm
- ASCA3** - 400 x 200 mm
- ASCA4** - 350 x 250 mm
- ASCA5** - 300 x 200 mm
- ASCA6** - 200 x 150 mm
- ASCA7** - 200 x 100 mm

ASCO - Scatolata alluminio da lastra anodizzata oro

- ASCO1** - 600 x 400 mm
- ASCO2** - 400 x 300 mm
- ASCO3** - 400 x 200 mm
- ASCO4** - 350 x 250 mm
- ASCO5** - 300 x 200 mm
- ASCO6** - 200 x 150 mm
- ASCO7** - 200 x 100 mm

ATU - Targa alluminio satinato bordo lucido verniciato

- ATU1** - 400 x 300 mm Sp. 2 mm
- ATU2** - 400 x 200 mm Sp. 2 mm
- ATU3** - 300 x 200 mm Sp. 2 mm
- ATU4** - 200 x 150 mm Sp. 2 mm
- ATU5** - 200 x 100 mm Sp. 2 mm



ABL - Targa alluminio satinato bordo lucido verniciato

- ABL1** - 400 x 300 mm Sp. 2 mm
- ABL2** - 400 x 200 mm Sp. 2 mm
- ABL3** - 300 x 200 mm Sp. 2 mm
- ABL4** - 200 x 150 mm Sp. 2 mm
- ABL5** - 200 x 100 mm Sp. 2 mm



ABA - Targa alluminio satinato bordo lucido verniciato con angoli arrotondati

- ABA1** - 400 x 300 mm Sp. 2 mm
- ABA2** - 400 x 200 mm Sp. 2 mm
- ABA3** - 300 x 200 mm Sp. 2 mm
- ABA4** - 200 x 150 mm Sp. 2 mm
- ABA5** - 200 x 100 mm Sp. 2 mm



Targhe alluminio

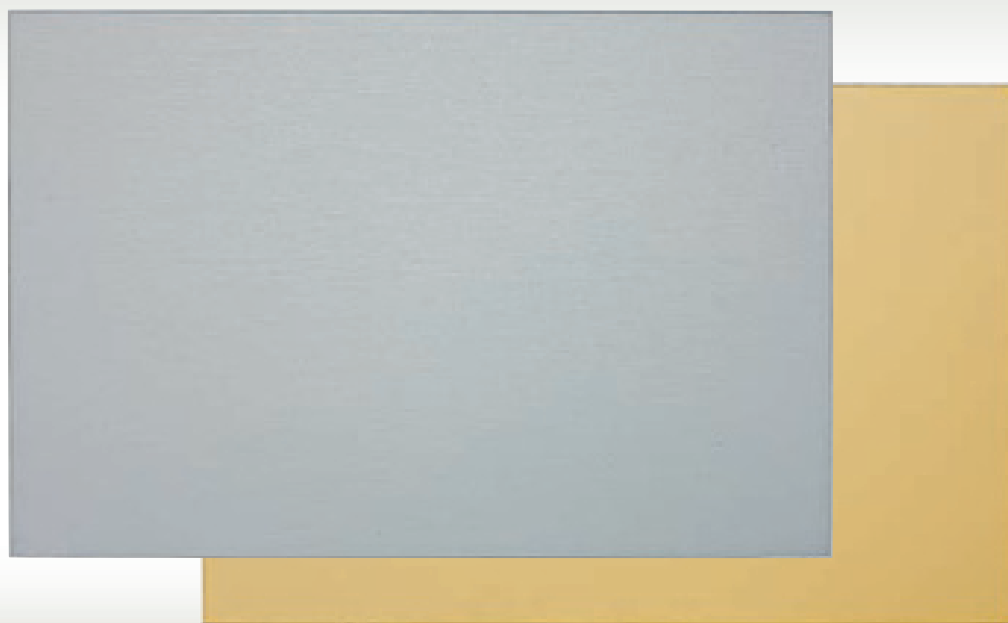

TAA - Targa alluminio anodizzato argento

TAA1 - 400 x 300 mm Sp. 2 mm

TAA2 - 300 x 200 mm Sp. 2 mm

TAA3 - 200 x 150 mm Sp. 2 mm

TAO - Targa alluminio anodizzato oro

TAO1 - 400 x 300 mm Sp. 2 mm

TAO2 - 300 x 200 mm Sp. 2 mm

TAO3 - 200 x 150 mm Sp. 2 mm

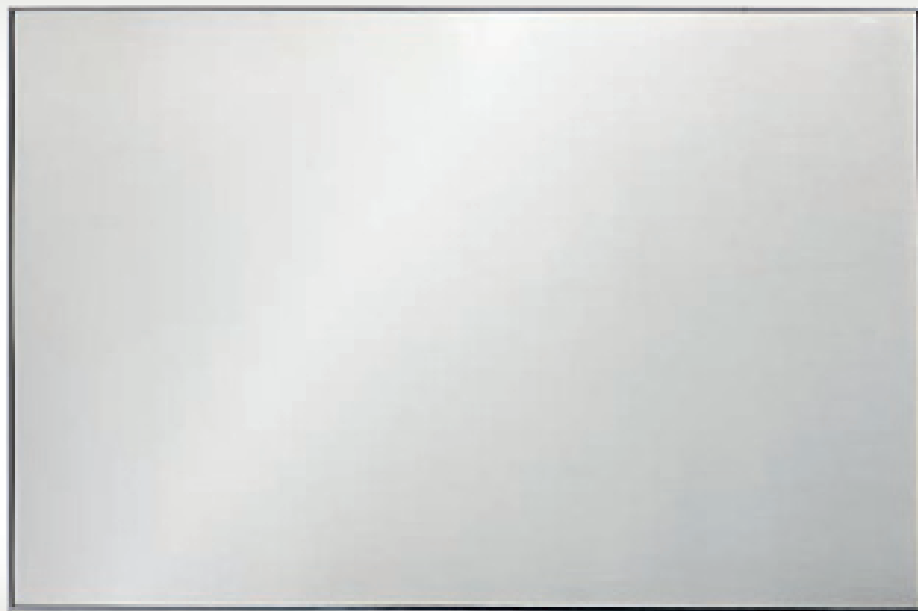

TAL/V - Targa alluminio lucido verniciato

TAL/V1 - 400 x 300 mm Sp. 2 mm

TAL/V2 - 300 x 200 mm Sp. 2 mm

TAL/V3 - 200 x 150 mm Sp. 2 mm

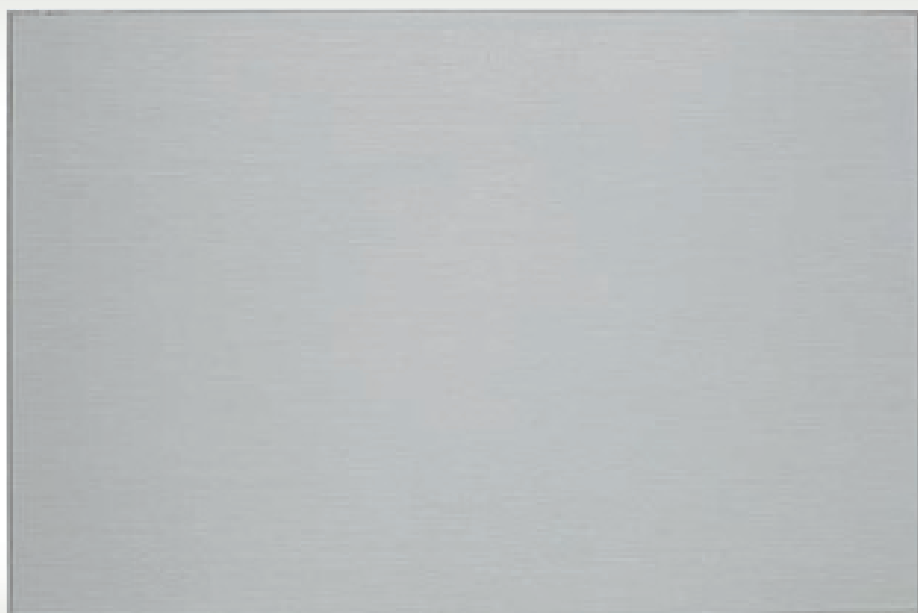

TAS/V - Targa alluminio satinato verniciato

TAS/V1 - 400 x 300 mm Sp. 2 mm

TAS/V2 - 300 x 200 mm Sp. 2 mm

TAS/V3 - 200 x 150 mm Sp. 2 mm

LA/A - Lastra alluminio anodizzato argento

- LA 1053/A** - 1000 x 500 mm Sp. 3 mm
- LA 1052/A** - 1000 x 500 mm Sp. 2 mm
- LA 1015/A** - 1000 x 500 mm Sp. 1,5 mm
- LA 1051/A** - 1000 x 500 mm Sp. 1 mm
- LA 1057/A** - 1220 x 500 mm Sp. 0,5mm

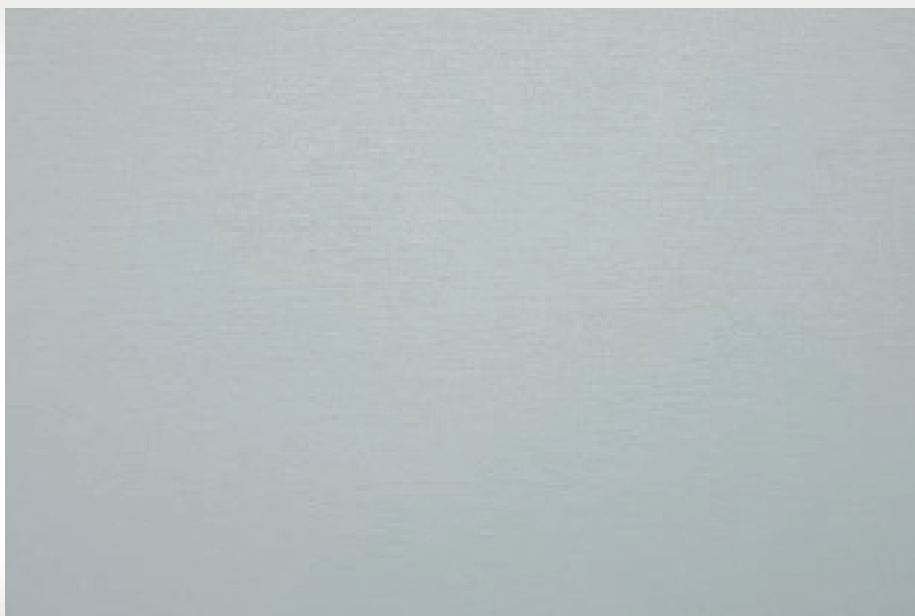
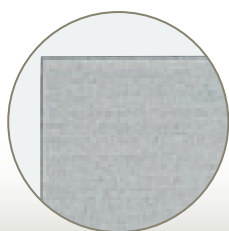

LA/O - Lastra alluminio anodizzato oro

- LA 1052/O** - 1000 x 500 mm Sp. 2 mm
- LA 1015/O** - 1000 x 500 mm Sp. 1,5 mm
- LA 1051/O** - 1000 x 500 mm Sp. 1 mm
- LA 1057/O** - 1220 x 500 mm Sp. 0,5mm

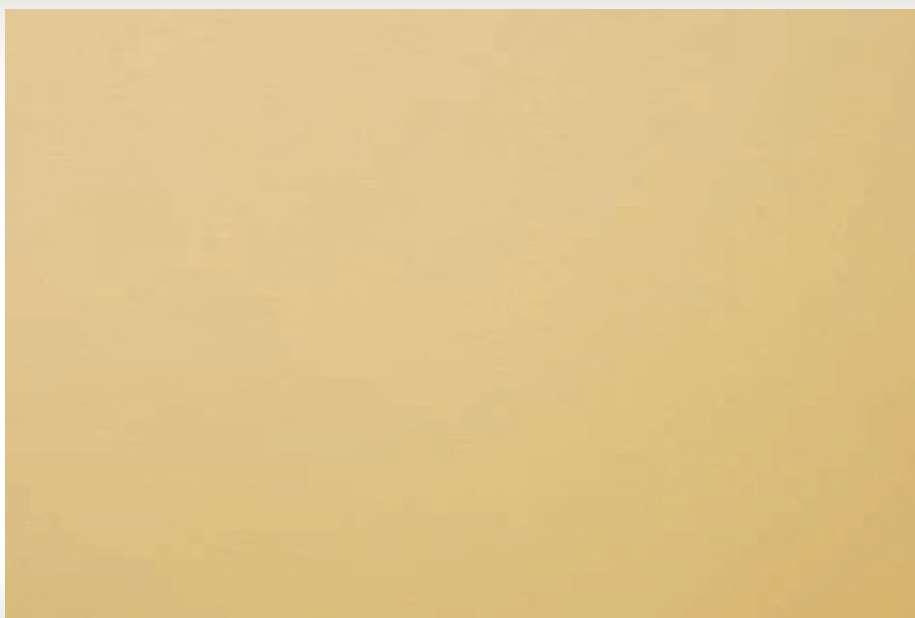
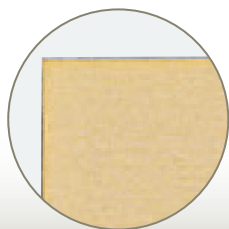

LA/B - Lastra alluminio preverniciato bianco

- LA 1052/B** - 1000 x 500 mm Sp. 2 mm
- LA 1015/B** - 1000 x 500 mm Sp. 1,5 mm
- LA 1051/B** - 1000 x 500 mm Sp. 1 mm
- LA 1055/B** - 1000 x 500 mm Sp. 0,5mm

LA/N - Lastra alluminio anodizzato nero

- LA 1052/N** - 1000 x 500 mm Sp. 2 mm
- LA 1015/N** - 1000 x 500 mm Sp. 1,5 mm
- LA 1051/N** - 1000 x 500 mm Sp. 1 mm
- LA 1055/N** - 1000 x 500 mm Sp. 0,5mm

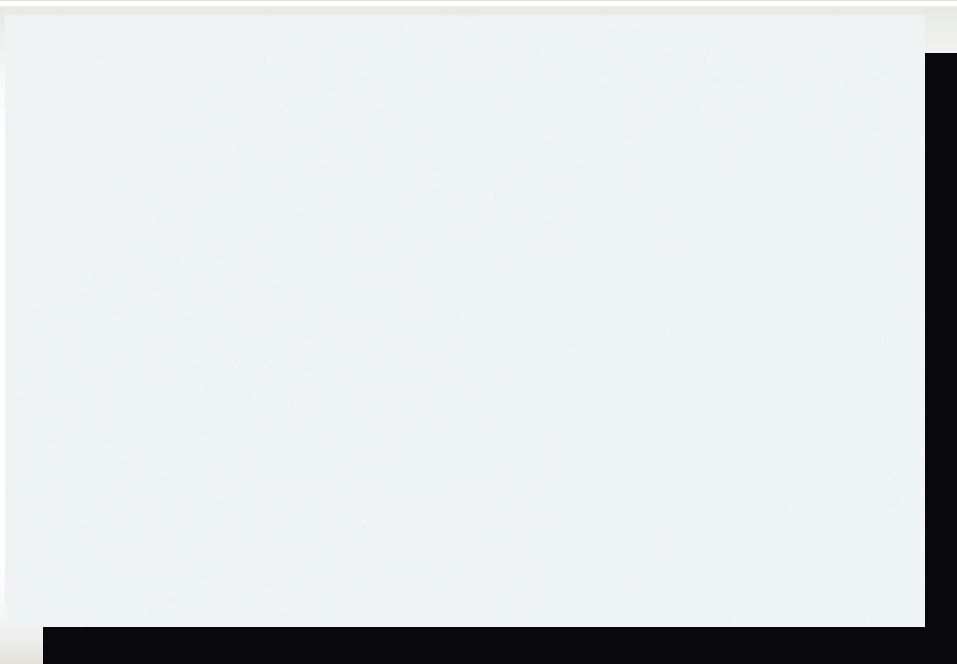

Lastre ottone

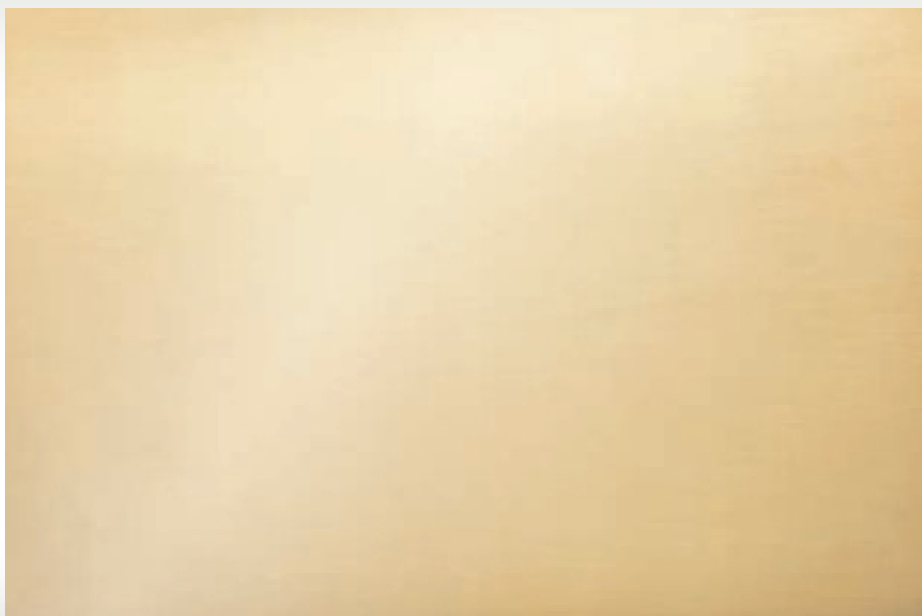

LL - Lastra ottone lucido

- LL 1063 - 1000 x 600 mm Sp. 3 mm
- LL 1062 - 1000 x 600 mm Sp. 2 mm
- LL 1015 - 1000 x 600 mm Sp. 1,5 mm
- LL 1061 - 1000 x 600 mm Sp. 1 mm
- LL 1067 - 1000 x 670 mm Sp. 0,7 mm
- LL 1065 - 1000 x 670 mm Sp. 0,5 mm

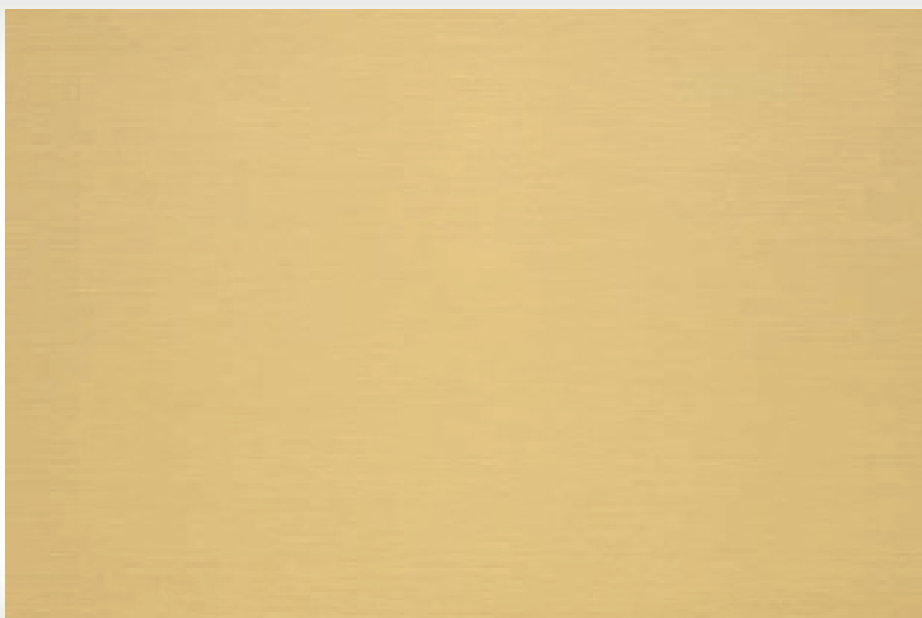
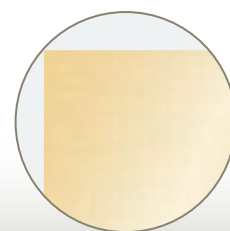

LS - Lastra ottone satinato

- LS 1063 - 1000 x 600 mm Sp. 3 mm
- LS 1062 - 1000 x 600 mm Sp. 2 mm
- LS 1015 - 1000 x 600 mm Sp. 1,5 mm
- LS 1061 - 1000 x 600 mm Sp. 1 mm
- LS 1067 - 1340 x 670 mm Sp. 0,7 mm
- LS 1065 - 1340 x 670 mm Sp. 0,5 mm

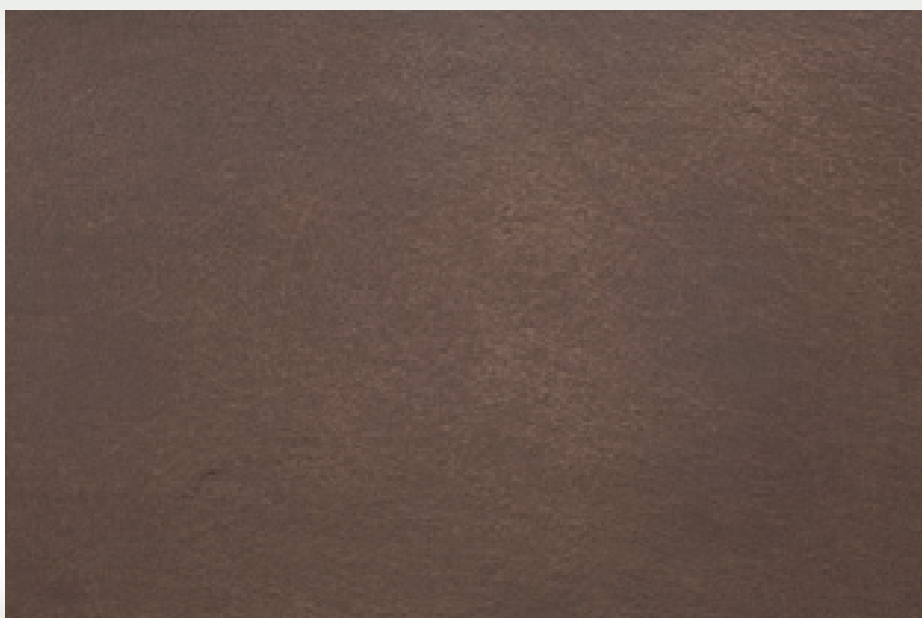
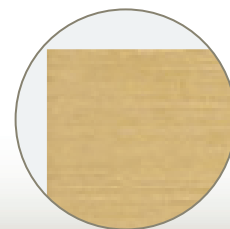

LB - Lastra ottone brunito

- LB 1062 - 1000 x 600 mm Sp. 2 mm
- LB 1015 - 1000 x 600 mm Sp. 1,5 mm
- LB 1061 - 1000 x 600 mm Sp. 1 mm
- LB 1067 - 1000 x 670 mm Sp. 0,7 mm

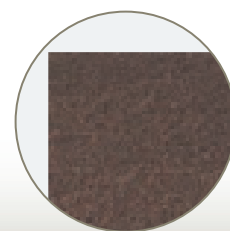

Targhe accoppiate con metacrilato

OTPX - Targa metacrilato trasparente bisellato
Sp. 10 mm con base ottone satinato
bordo lucido Sp. 2 mm.
Completa di borchie e distanziali

OTPX1 - 400 x 300 mm
OTPX2 - 300 x 200 mm



ATPX - Targa metacrilato trasparente bisellato
Sp. 10 mm con base alluminio satinato
bordo lucido Sp. 2 mm.
Completa di borchie e distanziali

ATPX1 - 400 x 300 mm
ATPX2 - 300 x 200 mm



AATPX - Targa metacrilato trasparente bisellato
Sp. 10 mm con base alluminio anodizzato
argento Sp. 2 mm.
Completa di borchie e distanziali

AATPX1 - 400 x 300 mm
AATPX2 - 300 x 200 mm



Pergamene e libri



PF1 - pergamena ottone lucido sbalzato
320 x 220 mm

PFB1 - pergamena ottone brunito sbalzato
320 x 220 mm



PF2 - pergamena ottone lucido sbalzato
200 x 180 mm

PFB2 - pergamena ottone brunito sbalzato
200 x 180



PF - Pergamena ottone lucido sbalzato

PF7 - 230 x 185 mm

PF8 - 170 x 130 mm

PF9 - 150 x 120 mm

PFB - Pergamena ottone brunito sbalzato

PFB7 - 230 x 185 mm

PFB8 - 170 x 130 mm

PFB9 - 150 x 120 mm

PF6 - pergamena ottone lucido sbalzato
200 x 70 mm

PFB6 - pergamena ottone brunito sbalzato
200 x 70 mm



PS - Pergamena ottone lucido/satinato

PS1 - 340 x 250 mm Sp. 2 mm

PS2 - 225 x 160 mm Sp. 2 mm

PS3 - 170 x 120 mm Sp. 2 mm

PS4 - 195 x 75 mm Sp. 2 mm

PB - Pergamena ottone brunito

PB1 - 340 x 250 mm Sp. 2 mm

PB2 - 225 x 160 mm Sp. 2 mm

PB3 - 170 x 120 mm Sp. 2 mm

PB4 - 195 x 75 mm Sp. 2 mm



LBO

Libro ottone brunito 230 x 155 mm Sp. 3 mm,
applicato su base ottone lucido
245 x 160 mm Sp. 2 mm



Targhe in metacrilato

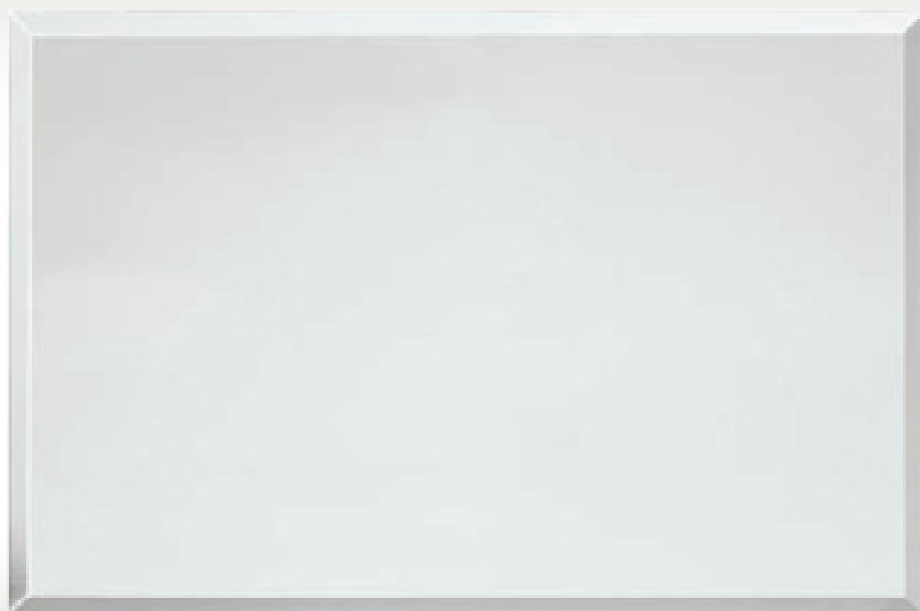

PLX SC - Targa metacrilato trasparente con smusso a 45° lucidato

- PLX SC1** - 400 x 300 mm Sp. 15 mm
- PLX SC2** - 300 x 200 mm Sp. 15 mm
- PLX SC3** - 200 x 150 mm Sp. 10 mm



PLX AR - Targa metacrilato trasparente taglio lucido di laser

- PLX AR1** - 400 x 300 mm Sp. 10 mm
- PLX AR2** - 300 x 200 mm Sp. 10 mm
- PLX AR3** - 200 x 150 mm Sp. 10 mm

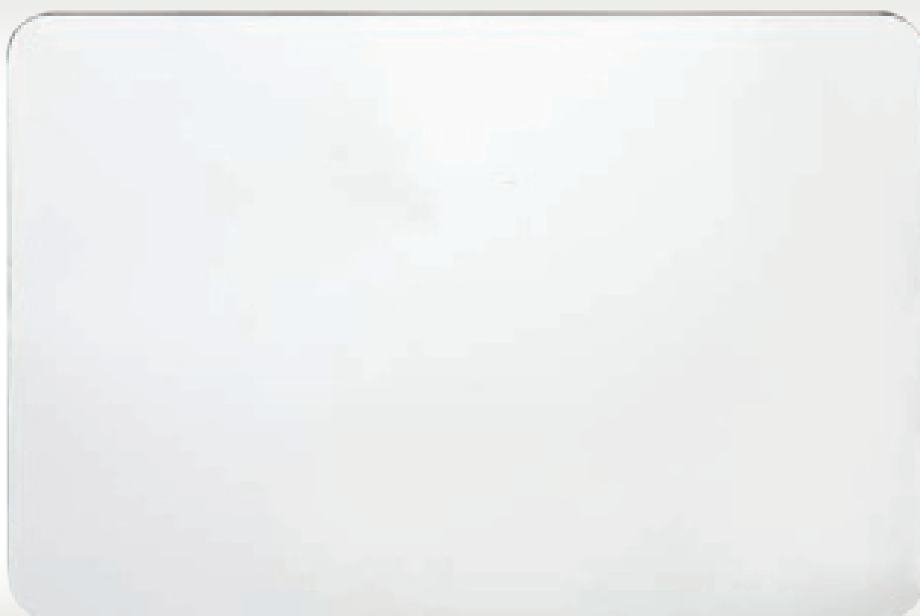

PLX AA - Targa metacrilato trasparente angoli arrotondati taglio lucido di laser

- PLX AA1** - 400 x 300 mm Sp. 10 mm
- PLX AA2** - 300 x 200 mm Sp. 10 mm
- PLX AA3** - 200 x 150 mm Sp. 10 mm

Telai portatarghe e fuoriporta



Telai portatarghe



DR - Cornice portatarghe in ottone lucido con targhe in ottone satinato

DR1 - cornice 316 x 616 mm
- 3 targhe 300 x 200 mm Sp.2

DR2 - cornice 216 x 376 mm
- 3 targhe 200 x 120 mm Sp.2

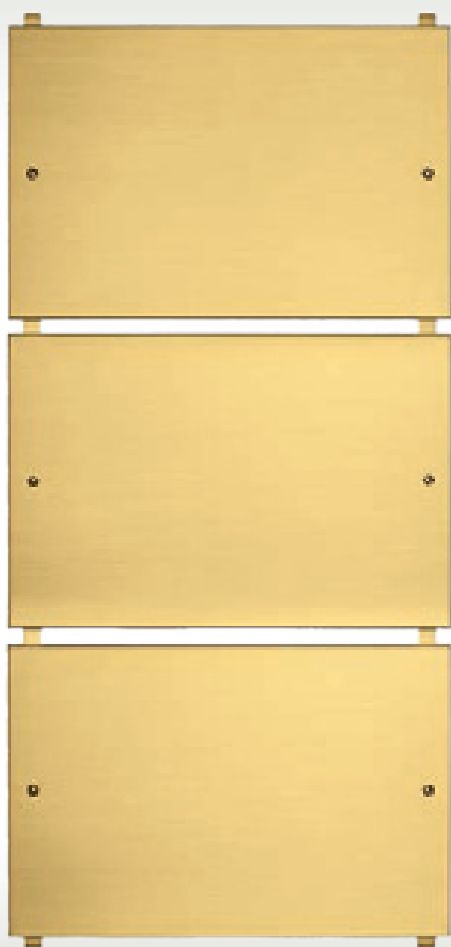

TEL - Telaio portatarghe in ottone satinato con targhe in ottone satinato

TEL1 - telaio 300 x 640 mm
- 3 targhe 300 x 200 mm Sp.2

TEL2 - Telaio 250 x 490 mm
- 3 targhe 250 x 150 mm Sp.2

TEL3 - Telaio 200 x 340 mm
- 3 targhe 200 x 100 mm Sp.2

DRA - Cornice portatarghe alluminio lucido
con targhe alluminio anodizzato argento

DRA1 - cornice 316 x 616 mm
- 3 targhe 300 x 200 mm Sp.2

DRA2 - cornice 216 x 376 mm
- 3 targhe 200 x 120 mm Sp.2



TELA - Telaio portatarghe alluminio satinato
con targhe alluminio anodizzato argento

TELA1 - telaio 300 x 640 mm
- 3 targhe 300 x 200 mm Sp.2

TELA2 - Telaio 250 x 490 mm
- 3 targhe 250 x 150 mm Sp.2

TELA3 - Telaio 200 x 340 mm
- 3 targhe 200 x 100 mm Sp.2



Telai portatarghe



TPX - Base portatarghe in metacrilato trasparente con targhe in ottone satinato

TPX1 - base 410 x 580 mm Sp.10
- 5 targhe 310 x 80 mm Sp.2

TPX2 - base 300 x 425 mm Sp.10
- 5 targhe 230 x 60 mm Sp.2



TPXA - Base portatarghe in metacrilato trasparente con targhe in alluminio anodizzato argento

TPXA1 - base 410 x 580 mm Sp.10
- 5 targhe 310 x 80 mm Sp.2

TPXA2 - base 300 x 425 mm Sp.10
- 5 targhe 230 x 60 mm Sp.2



FPB - Fuoriporta bifacciale convesso a bandiera in alluminio con tappo terminale in alluminio, attacco a muro e protezione in PVC trasparente

FPB1 - 300 x 210 mm

FPB2 - 210 x 150 mm

FPB3 - 150 x 100 mm



FP - Fuoriporta convesso in alluminio anodizzato con tappi terminali in alluminio e protezione in PVC trasparente. Utilizzabile in posizione orizzontale e verticale

FP1 - 300 x 210 mm

FP2 - 210 x 150 mm

FP3 - 150 x 100 mm



Portatarghe e fuoriporta: modelli personalizzati



es. 266



es. 267



es. 268



es. 269



es. 270



Distanziali

DISTANZIALI OTTONE CON BORCHIA PIATTA. Consentono il montaggio di pannelli e targhe di diversi formati e spessori. Grazie alla chiusura laterale con vite a brugola, il distanziale è adatto per montaggi di sicurezza. Necessita di chiave a brugola (non inclusa)



DOST1

distanziale ottone cromato opaco
ø 30 mm, h. 30 mm Sp. max 15 mm,
portata kg. 20



DOST2

distanziale ottone cromato opaco
ø 25 mm, h. 30 mm Sp. max 15 mm,
portata kg. 20



DOST3

distanziale ottone cromato opaco
ø 19 mm, h. 25 mm Sp. max 15 mm,
portata kg. 20

DOCT3

distanziale ottone cromato lucido
ø 19 mm, h. 25 mm Sp. max 15 mm,
portata kg. 20



DOOT1

distanziale ottone oro
ø 15 mm, h. 20 mm Sp. max 12 mm,
portata kg. 20

DOCT1

distanziale ottone cromato lucido
ø 15 mm, h. 20 mm Sp. max 12 mm,
portata kg. 20

DISTANZIALI ALLUMINIO CON BORCHIA PIATTA.

Consentono il montaggio di pannelli e targhe di diversi formati e spessori.

DAT1

distanziale alluminio anodizzato argento
 \varnothing 19 mm, h.25 mm Sp. max 14, portata 20 kg

DAT2

distanziale alluminio anodizzato argento
 \varnothing 13 mm, h.19 mm Sp. max 10, portata 20 kg

DAT3

distanziale alluminio anodizzato argento
 \varnothing 13 mm, h.13 mm Sp. max 6 mm, portata 15 kg



DAOT1

distanziale alluminio anodizzato oro
 \varnothing 19 mm, h.25 mm Sp. max 14, portata 20 kg

DAOT2

distanziale alluminio anodizzato oro
 \varnothing 13 mm, h.19 mm Sp. max 10, portata 20 kg

DAOT3

distanziale alluminio anodizzato oro
 \varnothing 13 mm, h.13 mm Sp. max 6 mm, portata 15 kg



DACT1

distanziale alluminio cromato
 \varnothing 19 mm, h.25 mm Sp. max 14, portata 20 kg

DACT2

distanziale alluminio cromato
 \varnothing 13 mm, h.19 mm Sp. max 10, portata 20 kg

DACT3

distanziale alluminio cromato
 \varnothing 13 mm, h.13 mm Sp. max 6 mm, portata 15 kg



Distanziali

DISTANZIALI ACCIAIO CON BORCHIA PIATTA. Distanziali in acciaio, consentono il montaggio di pannelli e targhe di diversi formati e spessori. Grazie alla chiusura laterale con vite a brugola, il distanziale è adatto per montaggi di sicurezza. Necessita di chiave a brugola (non inclusa)



DSTEEL1

distanziale acciaio satinato
ø 20 mm, h.20 mm Sp. max 12 mm,
portata kg. 20

DSTEEL2

distanziale acciaio satinato
ø 15 mm, h.15 mm Sp. max 10 mm,
portata kg. 15

DSTEEL3

distanziale acciaio satinato
ø 13 mm, h.15 mm Sp. max 8 mm,
portata kg. 15

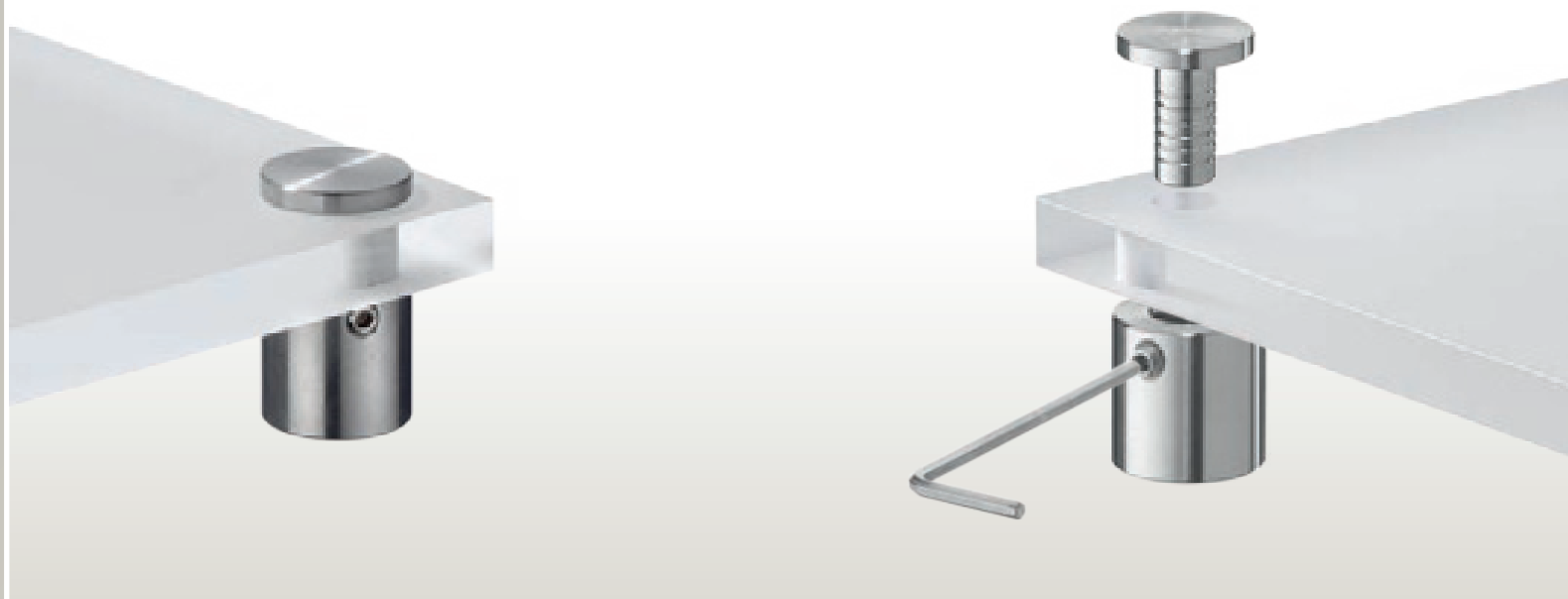

SIDE - Distanziale in alluminio anodizzato argento per targhe senza fori.
Necessita di chiave a brugola (non inclusa)

SIDE1 - distanziale laterale alluminio \varnothing 19 mm per targa Sp. max 10 mm

SIDE2 - distanziale laterale alluminio \varnothing 19 mm per targa Sp. max 4 mm



DB - Supporto per targa a parete/soffitto in alluminio anodizzato argento.
Necessita di chiave a brugola (non inclusa)

DB502 - Per targa Sp. max 4,5 mm, profondità utile 15 mm



DPT - Portatarga privo di fori a vista in alluminio anodizzato argento

DPT1 - portatarga alluminio 120 mm, per targa Sp. max 8 mm

DPT2 - portatarga alluminio 80 mm, per targa Sp. max 8 mm

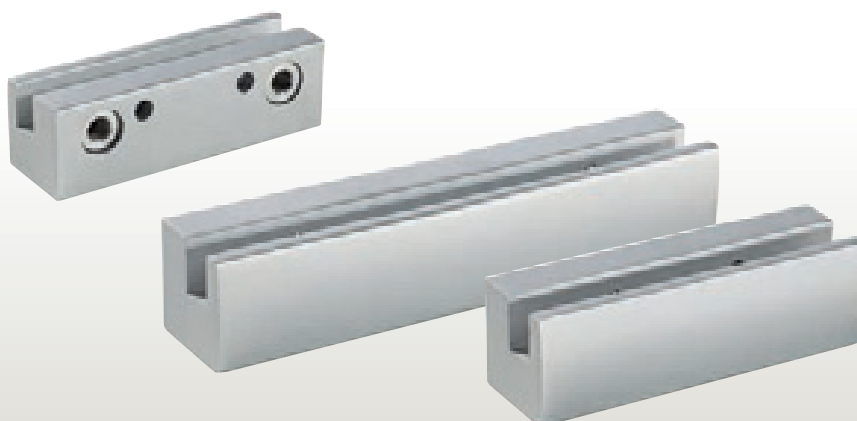

Borchie e distanziali



BF - Borchia ottone lucido coprivite
comprensiva di ghiera, vite e tassello

BF1 - Ø 16 mm

BF2 - Ø 12 mm

BF3 - Ø 9 mm



BF C - Borchia ottone cromato coprivite
comprensiva di ghiera, vite e tassello

BF1C - Ø 16 mm

BF2C - Ø 12 mm

BF3C - Ø 9 mm



BFR - Borchia ottone ramato coprivite
comprensiva di ghiera, vite e tassello

BF1R - Ø 16 mm

BF2R - Ø 12 mm

BF3R - Ø 9 mm

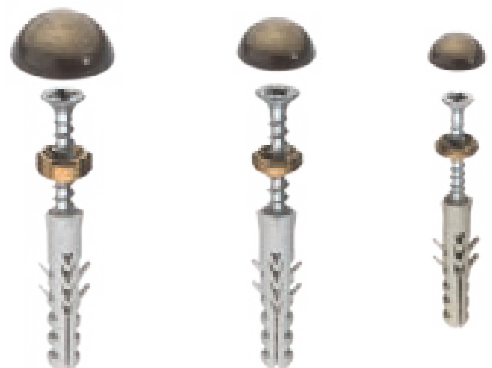

BFB - Borchia ottone brunito coprivite
comprensiva di ghiera, vite e tassello

BF1B - Ø 16 mm

BF2B - Ø 12 mm

BF3B - Ø 9 mm



TOC - Coprivite ottone cromato
comprensivo di ghiera, vite e tassello

TOC1 - Ø 25 mm

TOC2 - Ø 19 mm

TOC3 - Ø 15 mm



TAL/TOT - Coprivite comprensivo di ghiera,
vite e tassello

TAL - Coprivite alluminio argento ø 15 mm

TOT - Coprivite ottone oro ø 15 mm



Distanziale ottone lucido.

DST2 - Ø 15x15 mm

DST3 - Ø 15x10 mm



Distanziale ottone cromato

DST2C - Ø 15x15 mm

DST3C - Ø 15x10 mm



Distanziale metacrilato trasparente

DST1 - Ø 15x15 mm

DST6 - Ø 15x10 mm

DST7 - Ø 8 x 5 mm

VTAC - Vite ottone cromato autofilettante
testa a goccia

VTAO - Vite ottone lucido autofilettante
testa a goccia

VTC - Vite ottone cromato filettatura metrica
testa a goccia

VTO - Vite ottone lucido filettatura metrica
testa a goccia

(Per misure vedi listino)



DSP - Dispenser 100 ml

DSPC - Dispenser con colore nitro 100 ml



AGO - Ago per dispenser (formati vari)



BLACK1 - Anneritore per ottone 150 ml

BLACK2 - Anneritore per alluminio 100 ml



Cornici e crest in legno



LGR - Base rettangolare
in legno MDF rimessato

LGR1 - 440 x 340 mm Sp. 15 mm
LGR2 - 440 x 240 mm Sp. 15 mm
LGR3 - 340 x 240 mm Sp. 15 mm
LGR4 - 240 x 190 mm Sp. 15 mm
LGR5 - 240 x 140 mm Sp. 15 mm

LGO - Base ovale in legno MDF rimessato

LGO1 - 440 x 280 mm Sp. 15 mm
LGO2 - 340 x 220 mm Sp. 15 mm
LGO3 - 290 x 190 mm Sp. 15 mm
LGO4 - 240 x 150 mm Sp. 15 mm



CR - Crest in legno MDF rimessato

CR1 - 160 x 190 mm Sp. 15 mm
CR2 - 130 x 160 mm Sp. 15 mm

CR3 - 220 x 290 mm Sp. 15 mm
CR4 - 160 x 220 mm Sp. 15 mm

CR5 - 170 x 230 mm Sp. 15 mm
CR6 - 130 x 180 mm Sp. 15 mm

CR7 - 200 x 240 mm Sp. 15 mm
CR8 - 170 x 220 mm Sp. 15 mm

Scritte, numeri e loghi





Aoz/9

LP - Lettera ottone lucido
h. 50 mm Sp. 3 mm

NP - Numero ottone lucido
h. 50 mm Sp. 3 mm



Aoz/9

LM - Lettera ottone satinato/brunito
h. 90 mm Sp. 3 mm

NM - Numero ottone satinato/brunito
h. 90 mm Sp. 3 mm



Aoz/9

LG - Lettera ottone satinato/brunito
h. 120 mm Sp. 3 mm

NG - Numero ottone satinato/brunito
h. 120 mm Sp. 3 mm

es. 301

Scritta ottone lucido h. 75 mm Sp. 5 mm
e h. 25 mm Sp. 3 mm

FERRAZZI
Creazioni Italiane

es. 302

Scritta ottone lucido h. 65 mm Sp. 2 mm

Robert Jones David

es. 303

Scritta ottone satinato h. 45 mm Sp. 1,5 mm

Il Nido dei Cuccioli

es. 304

Scritta ottone lucido h. 52 mm Sp. 3 mm

Tenuta Rinaldi

Scritte, numeri e loghi



es. 305

Araldica scontornata in ottone lucido inciso e smaltato a colori h. 200 mm Sp. 3 mm



es. 306

Araldica scontornata in ottone lucido inciso e smaltato h. 133 mm Sp. 3 mm

Residence Tiziano

es. 307

Scritta ottone brunito h. 67 mm Sp. 3 mm



es. 308

Scritta ottone lucido
200 x 200 mm Sp. 3 mm

es. 309

Scritta alluminio cromato/verniciato rosso
h. 175 mm Sp. 5 mm

H&S

es. 310

Scritta alluminio lucido h. 75 mm Sp. 3 mm

ROTIS

es. 311

Scritta alluminio brunito
h. 105 mm Sp. 2 mm

Villa Cortese

es. 312

Scritta alluminio satinato verniciato
h. 110 mm Sp. 2 mm

Podere
Stresa

Scritte, numeri e loghi

**FAST
SERVICE**



es. 313

Scritta ottone cromato e metacrilato nero
h. lettera 38 mm Sp. 3+10 mm

V37

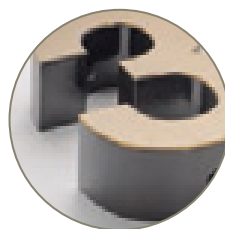

es. 314

Scritta ottone satinato e metacrilato verniciato
h. 130 mm Sp. 1+30 mm

S



es. 315

Scritta ottone cromato e metacrilato
trasparente h. 208 mm Sp. 3+10 mm

UMB

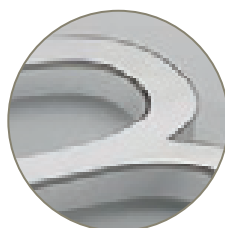

es. 316

Scritta acciaio lucido e metacrilato sabbato
h. 120 mm Sp. 2+10 mm

BALNEARE
CANOTTI

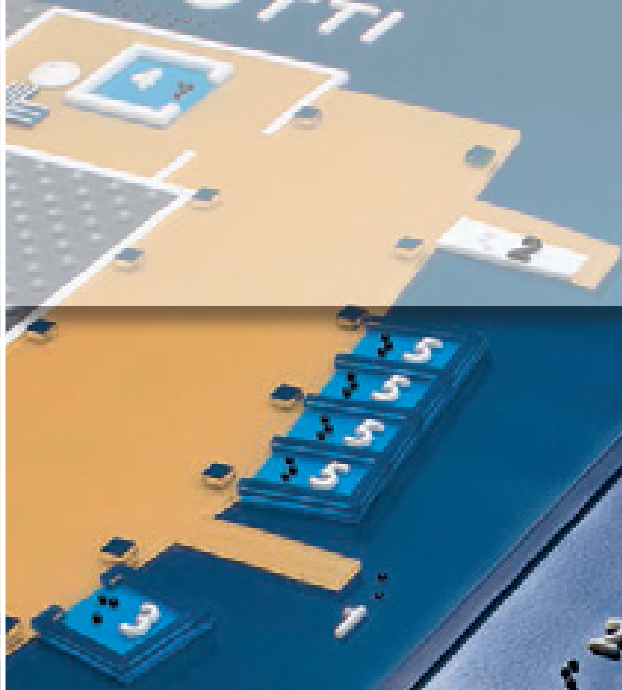

LEGENDA/LEGEND:
● SEI QUI/YOU ARE HERE

■ PASSERELLA/FOOTPATH

≡ PERCORSO/ROUTE

○ PIASTRO/PILASTER

— PARETE/WALL

1 ALLA SPIAGGIA/TO BEACH

2 AREA DOCCE/SHOWERS AREA

3 PRIMO SOCCORSO/FIRST AID

4 SERVIZI IGIENICI/TOILETS

5 SPOGLIA TOIO/DRESSING ROOM

6 BAR

LA SCALA I PALLINI INDICANO
SOMMITA'/STAIRS



es. 317

Targhe calandrate per corrimano, in alluminio verniciato colorato con scritte a rilievo e scritta braille
150 x 40 x 1,3 mm; 210 x 40 x 1,3 mm



es. 318

Targa in alluminio verniciato mm 600 x 400 con particolari in metacrilato verniciati e applicati, testi braille



es. 319

Targa in ottone brunito mm 210 x 150 x 2 con testi e scritte braille applicate

es. 320

Targa da premiazione in alluminio bianco mm 200 x 150 x 2 con stampa digitale e testi braille, montata su astuccio velluto blu



es. 321

Targa in metacrilato colorato mm 200 x 200 x 5 con braille, soggetto e scritta a rilievo



es. 322

Medaglie in alluminio ø 80 mm con inserto in metacrilato colorato con stampa digitale e braille





es. 323

Targa in alluminio verniciato beige
mm 200 x 150 x 2 con stampa digitale,
grafica a rilievo e braille



es. 324

Targa in metacrilato verniciato grigio
ø 180 mm Sp. 6 mm con braille e
scritta a rilievo

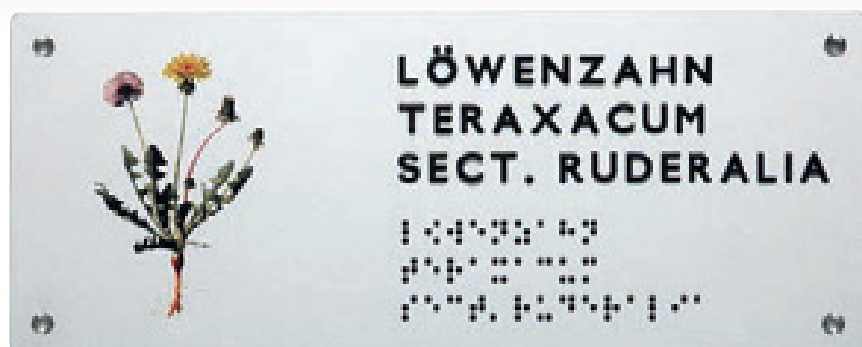

es. 325

Targa in alluminio anodizzato argento
mm 250 x 100 x 2 con braille,
scritte a rilievo e stampa digitale



es. 326

Piastrina in alluminio sabbato sagomata e
calandrata con scritta a rilievo e braille



Alberghiera



TH1

Targa in ottone satinato con taglio lucido
mm 320 x 220 x 2 incisa e smaltata con
logo lucido



THSC1

Scatolata in ottone satinato con fianchi lucidi
mm 320 x 220 x 2 incisa e smaltata con logo
lucido



TH3

Ovale in ottone lucido
mm 300 x 190 x 3 inciso e smaltato



TH4

Targa in metacrilato trasparente
mm 320 x 220 x 3 con stampa digitale
sul retro e fondo verniciato bianco



TH5

Targa in metacrilato trasparente con
smusso a 45° lucidato mm 320 x 220 x 10
con stampa digitale sul retro

SNL - Segnanome in legno con targa
in ottone satinato bordo lucido

Legno: mm 200 x 55
Targa: mm 200 x 42 x 2



SN - Segnaposto in metacrilato trasparente
con targa ottone satinato

SN1 - Metacrilato: 190 x 80 mm - targa: 170 x 60 x 1,5 mm
SN2 - Metacrilato: 170 x 60 mm - targa: 160 x 50 x 1,5 mm
SN3 - Metacrilato: 130 x 50 mm - targa: 120 x 40 x 1,5 mm



CA - Cavallotto/segnaposto in metacrilato
trasparente per inserire cartoncino o carta comune

CA1 - 250 x 85 x 85 mm - inserto: 250 x 80 mm
CA2 - 200 x 103 x 103 mm - inserto: 200 x 100 mm
CA3 - 200 x 80 x 80 mm - inserto: 200 x 76 mm
CA4 - 180 x 65 x 65 mm - inserto: 180 x 61 mm
CA5 - 150 x 65 x 65 mm - inserto: 150 x 60 mm
CA6 - 120 x 60 x 60 mm - inserto: 120 x 55 mm

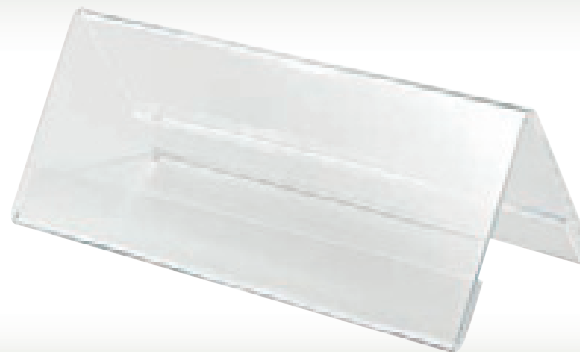

PAV - Porta avvisi/comunicazioni in metacrilato
trasparente per inserire cartoncino o carta comune

PAV1 - 210 x 303 x 100 mm - inserto: 210 x 76 mm
PAV2 - 150 x 105 x 32 mm - inserto: 150 x 100 mm
PAV3 - 200 x 190 x 32 mm - inserto: 110 x 85 mm
PAV4 - 100 x 70 x 32 mm - inserto: 100 x 65 mm
PAV5 - 83 x 60 x 32 mm - inserto: 83 x 55 mm



VR4

Targa ottone bordo lucido con piega
mm 180 x 85 + 45 Sp. 2 mm





SP4 - Segnaposto in legno con targa ottone satinato (bifaciale)

Legno: mm 55 x 50
Targa: mm 55 x 40 x 2



SP5 - Segnaposto in ottone satinato bordo lucido mm 60 x 60 x 2

La foto riporta un esempio di incisione



SP6 - Segnaposto in alluminio anodizzato argento mm 60 x 60 x 2

La foto riporta un esempio di incisione



SP7 - Segnaposto in metacrilato oro mm 60 x 60 x 3 con con cornicetta incisa

SP8. Segnaposto in metacrilato bianco mm 60 x 60 x 3 con con cornicetta incisa

La foto riporta un esempio di incisione.

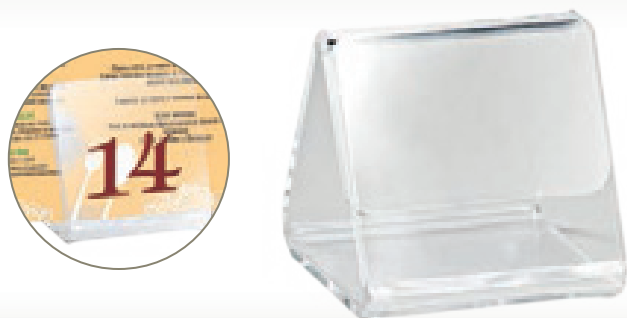

SP9 - Segnaposto triangolare in metacrilato trasparente mm 60 x 60 x 3, con fessura per inserimento biglietto o menu

La foto riporta un esempio di utilizzo

SP10 - Segnaposto con porta menu in metacrilato bianco mm 90 x 50 x 25 con targhetta alluminio nero

La foto riporta un esempio di incisione



SP11 - Segnaposto in metacrilato bianco mm 90 x 50 x 20

La foto riporta un esempio di incisione



SP12 - Segnaposto con porta menu in metacrilato nero mm 90 x 50 x 20

La foto riporta un esempio di incisione



SP13/SP14/SP15 - Segnaposto in metacrilato base 80 x 50 x 10 mm, h. 100 mm

La foto riporta un esempio di stampa.



SP13



SP14



SP15

SP16 - Segnaposto in ottone lucido con piega mm 70 x 145 x 2

La foto riporta un esempio di incisione



Alberghiera



PH1

Portachiavi in ottone pressofuso lucido mm 90 x 40 con gommino trasparente

PH2

Portachiavi in ottone pressofuso brunito mm 90 x 40 con gommino trasparente



PH3

Portachiavi in ottone lucido mm 85 x 45 x 5 con gommino trasparente



PH4

Portachiavi in ottone lucido mm 34 x 77 x 5 con 2 gommini trasparenti



G1

Gancio in ottone satinato mm 45 x 24

G2

Gancio in ottone satinato mm 35 x 22

G3C

Gancio in ottone cromato mm 30 x 33

G3

Gancio in ottone satinato mm 30 x 33

PH10

Portachiavi in ottone satinato
mm 54 x 85 x 0,7 con logo e
numero incisi e smaltati

PH11

Portachiavi accoppiato fronte metacrilato,
retro alluminio mm 40 x 90 x 8 con
targhetta alluminio anodizzato nero laserata

PH12

Portachiavi in alluminio satinato
mm 30 x 80 x 4 inciso e smaltato,
con gommino

PH13

Portachiavi in metacrilato bianco
mm 40 x 150 x 10 inciso e smaltato

PH14

Portachiavi in alluminio satinato
mm 90 x 55 x 5 inciso e smaltato,
con gommino trasparente

PH15

Portachiavi in ottone lucido
ø 70 mm Sp. 5 mm inciso e smaltato

PH4A

Portachiavi in alluminio lucido
mm 34 x 77 x 5 inciso e smaltato,
con 2 gommini trasparenti



Alberghiera



UNI1 - Portanome laminato oro/argento
mm 61 x 26 con spilla sul retro

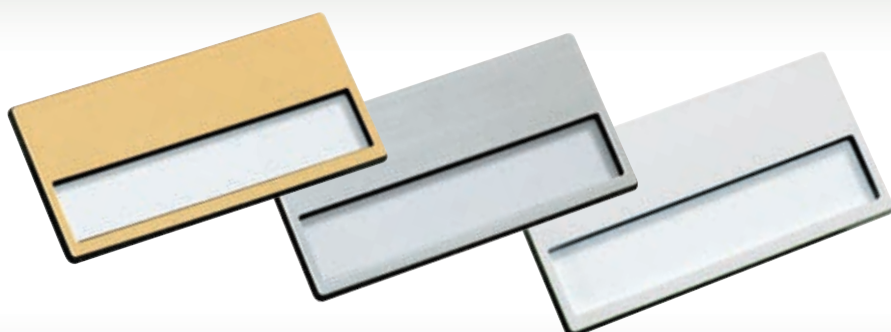

UNI2 - Portanome plastica oro/argento/bianco
mm 68 x 33 con spilla sul retro



UNI3/O - Portanome ottone lucido
mm 60 x 30 con spilla o calamita

UNI3/A - Portanome alluminio argento
mm 60 x 30 con spilla o calamita

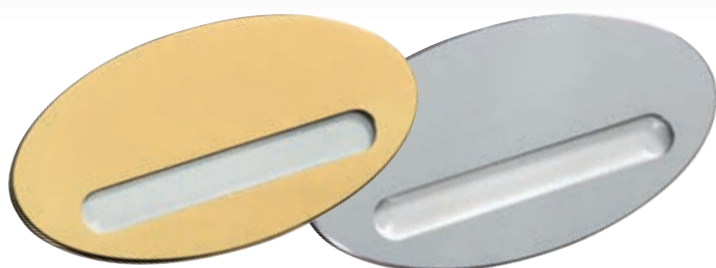

UNI4/O - Portanome ovale ottone lucido
mm 70 x 37 con spilla o calamita

UNI4/A - Portanome ovale alluminio argento
mm 70 x 37 con spilla o calamita

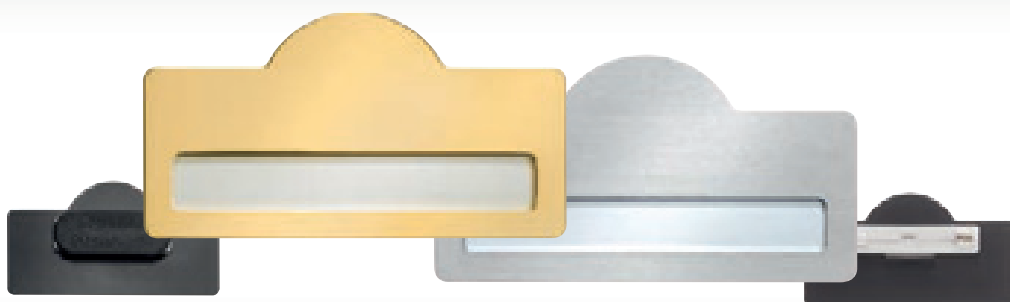

UNI5/O - Portanome sagomato ottone lucido
mm 60 x 33 con spilla o calamita

UNI5/A - Portanome sagomato alluminio
argento mm 60 x 33 con spilla o calamita



Spilla 1



Spilla 2



Spilla 3



Spilla 4

Spille

- SPILLA 1** - 35x10 mm spilla adesiva
- SPILLA 2** - 35x7 mm spilla adesiva
- SPILLA 3** - 34x10 mm spilla magnetica adesiva
- SPILLA 4** - ø 17 mm spilla magnetica adesiva

es. 334

Spilla sagomata in metacrilato trasparente mm 70 x 31 x 2 con stampa digitale e magnete sul retro



es. 335

Portanome sagomato in alluminio satinato mm 61 x 25 incisa con smalto, con chiodini sul retro



es. 336

Portanome sagomato in ottone lucido mm 58 x 33 con marcatura laser e spilla o magnete sul retro

es. 337

Portanome sagomato in ottone brunito mm 58 x 33 con marcatura laser e spilla o magnete sul retro



es. 338

Spilla in alluminio lucido mm 74 x 25 con logo traforato e inciso con smalto, magnete sul retro



Alberghiera



Ovale ottone satinato bordo lucido

- TE1** - mm 120 x 70 x 2 inciso donna
- TE2** - mm 120 x 70 x 2 inciso uomo
- TE22** - mm 120 x 80 x 2 inciso disabile



Ovale alluminio anodizzato argento taglio lucido

- TE5** - mm 120 x 70 x 2 inciso donna
- TE6** - mm 120 x 70 x 2 inciso uomo
- TE66** - mm 120 x 80 x 2 inciso disabile

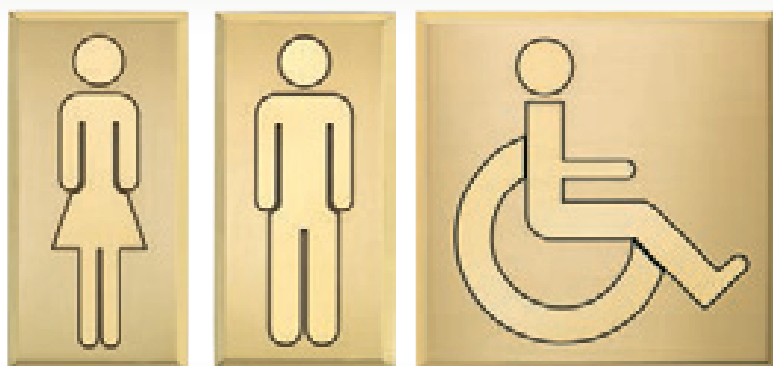

Targa ottone satinato taglio lucido

- TE3** - mm 120 x 60 x 2 inciso donna
- TE4** - mm 120 x 60 x 2 inciso uomo
- TE44** - mm 120 x 120 x 2 inciso disabile

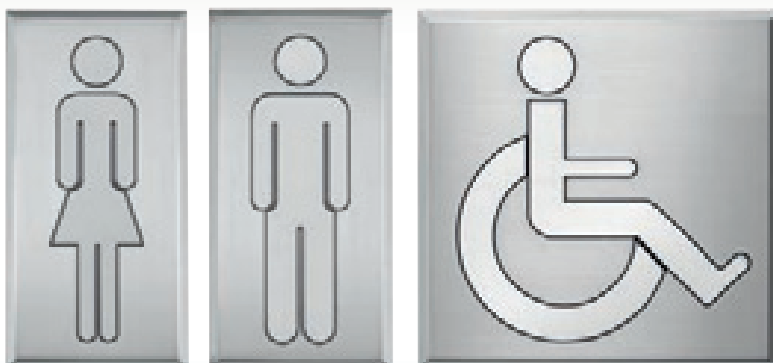

Targa alluminio satinato taglio lucido

- TE7** - mm 120 x 60 x 2 inciso donna
- TE8** - mm 120 x 60 x 2 inciso uomo
- TE88** - mm 120 x 120 x 2 inciso disabile

Sagoma in ottone lucido h. 90 mm, Sp. 3 mm
con perni o biadesivo

- TE9** - soggetto toilette "BAMBINA"
- TE10** - soggetto toilette "BAMBINO"



Targa in metacrilato trasparente
mm 100 x 100 x 3 con fondo stampato e
applicata targa in alluminio satinato con
soggetto traforato, con biadesivo

- TE11** - soggetto "DONNA"
- TE12** - soggetto "UOMO"



Targa accoppiata in metacrilato bianco
con soggetto traforato e targa di
fondo alluminio nero mm 110 x 110 x 5.
Supporto in alluminio (art. DPT2)

- TE14** - soggetto "DONNA"
- TE15** - soggetto "UOMO"
- TE16** - soggetto "DISABILE"



Alberghiera - Piantane



PT1 - Piantana ottone
h. 1400 mm, base ø 350 mm

PT2 - Piantana acciaio
h. 1400 mm, base ø 350 mm

PT3 - Piantana ottone
h. 1100 mm, base ø 250 mm

PT4 - Piantana acciaio
h. 1100 mm, base ø 250 mm



MOS1 - Capocorda con moschettone
ottone lucido

MOS2 - Capocorda con moschettone
ottone cromato

CORDA - Cordone ø 25 mm rosso/blu



SUP - Supporto 60 x 52 mm, Sp. 10 mm,
con fresatura per inserimento targa
Sp. 2 mm

SUP3 - alluminio satinato oro

SUP4 - alluminio satinato argento

Alberghiera - Piantane

PT6

Piantana con base in ferro e cover in alluminio
mm 33 x 25;
palo in alluminio h. 860 mm

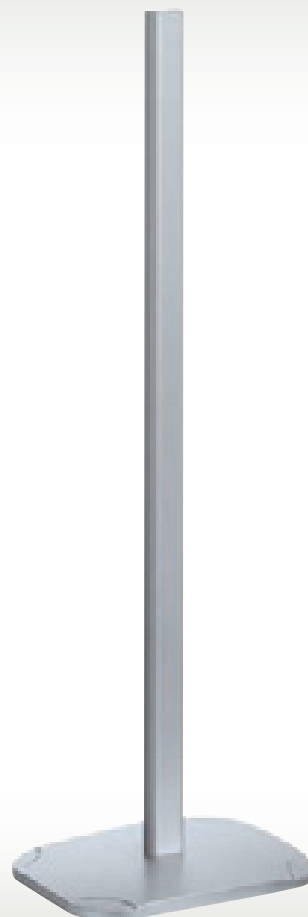

DEP - Porta-depliant a muro o per piantana,
in metacrilato trasparente

- DEP1** - 4 tasche per formato A4
- DEP2** - 4 tasche per formato A5



RDG - Cornice in alluminio a muro o
per piantana, con chiusura a scatto per
inserimento foglio/cartoncino

- RDG1** - angoli retti, mm 297 x 210 (A4)
- RDG2** - angoli retti, mm 420 x 297 (A3)
- RDG3** - angoli retti, mm 700 x 500 (B2)
- RDG4** - angoli arrotondati, mm 297 x 210 (A4)
- RDG5** - angoli arrotondati, mm 420 x 297 (A3)
- RDG6** - angoli arrotondati, mm 700 x 500 (B2)

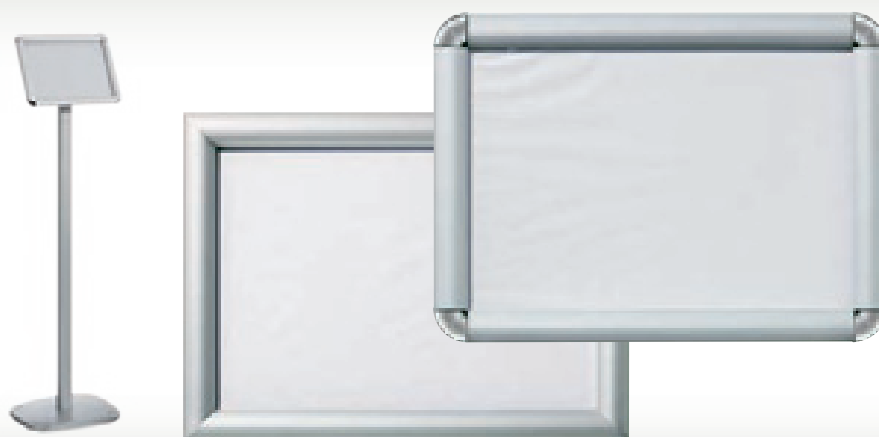

Alberghiera - Piantane



es. 339

Piantana ottone h. 1000 mm
con porta menu 455 x 330 mm



es. 340

Piantana ottone h. 1100 mm
con targa ottone, logo applicato, incisione
e braille



PT7

Piantana ottone h. 1200 mm
con porta menu in legno MDF e
metacrilato trasparente per foglio A3

Alberghiera - Piantane

es. 341

Piantana in acciaio h. 1150 mm
con targa in acciaio mm 300 x 200 x 5 incisa,
smaltata e con logo applicato



es. 342

Piantana in ferro verniciato grigio micaceo
h. 1250 mm con pieghe e targa ottone fondo
inciso brunito mm 300 x 200 con logo e scritte a
rilievo satinati e smalti colorati



es. 343

Piantana/leggio in metacrilato trasparente
h. 1320 mm con targa sul fronte in metacrilato
sabbato incisa, smaltata e con applicata scritta
in ottone cromato





Targhe e lavorazioni per industria



Incisione chimica



es. 352

Targhetta ottone con fondo inciso opaco e grafica a rilievo lucido realizzata in incisione chimica 60 x 20 x 0,8 mm

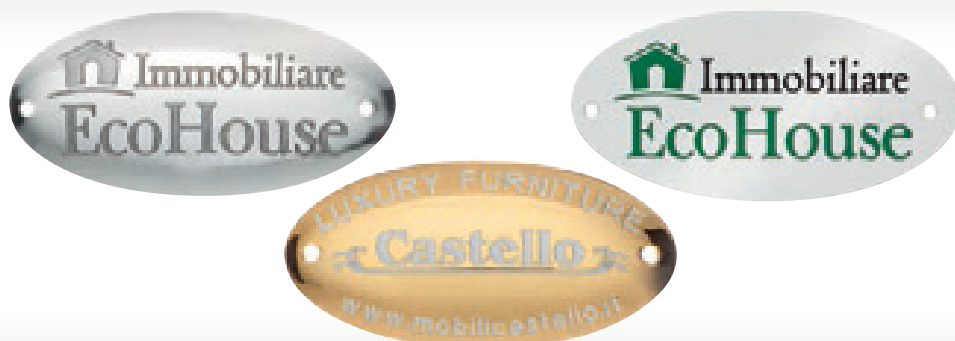

es. 353

Ovalino in acciaio lucido bombato, con incisione chimica
Ovalino in ottone lucido dorato bombato, con incisione chimica e smalto
Ovalino in acciaio lucido, con incisione chimica e smalto
70 x 24 mm



es. 354

Targhetta in acciaio con fondo opaco, inciso chimicamente, 70 x 40 x 1 mm;
Targhetta in acciaio lucido, incisa chimicamente, 65 x 45 x 1 mm



es. 355

Targhetta acciaio lucido 50 x 22 x 0,5 mm con incisione chimica e smalti

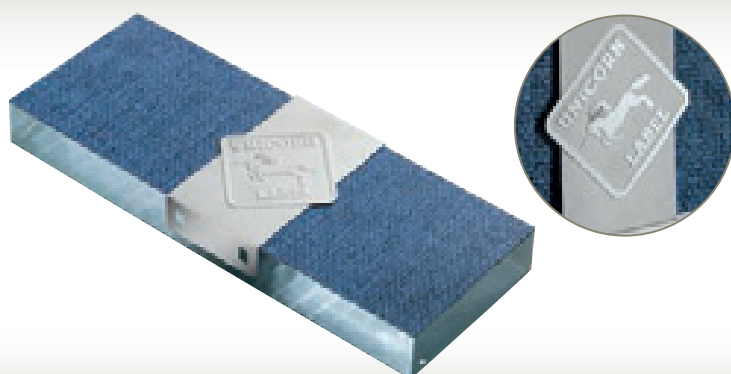

es. 356

Targhetta sagomata piegata, in acciaio lucido con fondo opaco inciso chimicamente
70 x 50 x 0,5 mm

es. 357

Targhetta in acciaio lucido con incisione chimica opaca 120 x 100 x 0,5 mm



es. 358

Targhetta in acciaio lucido con incisione chimica 135 x 89 x 0,5 mm



es. 359

Targhetta in acciaio lucido piegata 100 x 50 x 0,5 mm con incisione chimica e smalti



es. 360

Targhette in acciaio lucido 100 x 40 x 0,5 mm, incisione chimica con e senza smalti

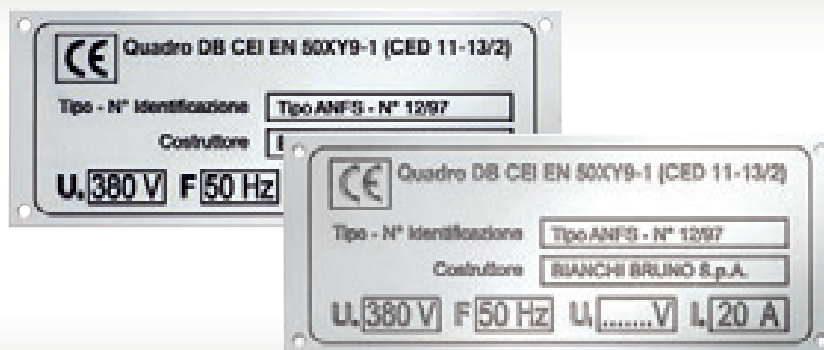

es. 361

Targhette in acciaio lucido 60 x 20 x 0,5 mm incisione chimica con e senza smalti



Incisione chimica

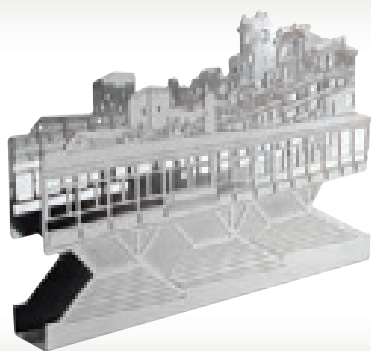

es. 362

Portabiglietti in acciaio Sp. 0,5 mm piegato, realizzato in incisione chimica, da applicare su base



es. 363

Segnalibro e porta biglietti da visita in acciaio lucido con incisione chimica Sp. 0,5 mm

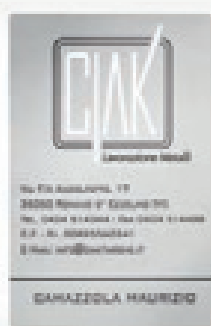

es. 364

Biglietto da visita e porta biglietti da visita in acciaio lucido con incisione chimica Sp. 0,5 mm

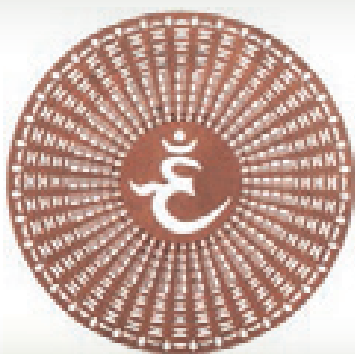

es. 365

Esempi di lavorazione in incisione chimica



es. 366

Lavorazioni in acciaio lucido Sp. 0,5 mm realizzate in incisione chimica

es. 367

Targhetta in alluminio anodizzato argento
mm 120 x 70 x 1 con stampa serigrafica
del fondo



es. 368

Targhetta in alluminio preverniciato bianco
mm 120 x 60 x 1 con stampa digitale

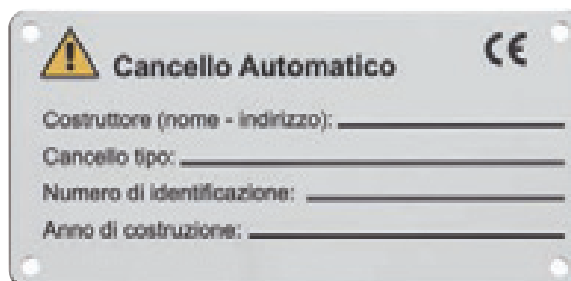

es. 369

Targhetta in alluminio anodizzato argento
mm 120 x 60 x 1 con stampa ad assorbimento



Incisione e marcatura laser



es. 370

Targhetta in alluminio anodizzato nero
mm 120 x 60 x 1 con marcatura laser



es. 371

Targhetta in acciaio lucido
mm 170 x 40 x 1 con marcatura laser

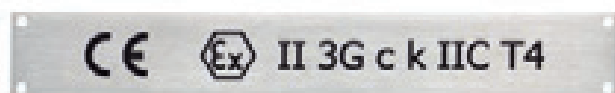

es. 372

Targhette in acciaio satinato con
marcatura laser.
110 x 16 x 0,8 mm
90 x 25 x 0,5 mm



es. 373

Particolare di tubo in alluminio \varnothing 20 mm con
marcatura laser in tondo;
Manopola in alluminio \varnothing 43 mm con
marcatura circolare a laser

Incisione e marcatura laser

es. 374

Targhetta in acciaio lucido mm 70 x 23 x 0,8
con marcatura laser



es. 375

Medaglie in acciaio lucido mm 27 x 48 x 0,6
con marcatura laser nera e grigia



es. 376

Spille in ottone nichelato nero con marcatura
laser e verniciatura
mm 18 x 18 Sp. 1
mm ø 20 Sp. 1



es. 377

Tubi in ottone argentato e ottone brunito
ø 45 mm, con marcatura circolare a laser



Lavorazioni particolari



es. 378

Ghiera in alluminio satinato
ø 200 mm Sp. 15 mm,
incisa senza smalto

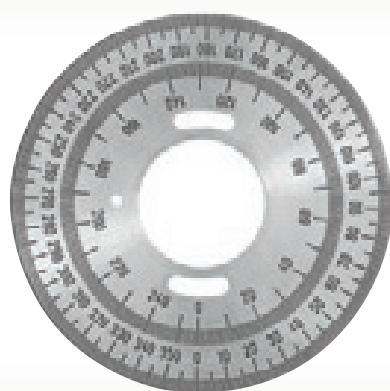

es. 379

Goniometro in acciaio satinato
ø 135 mm Sp. 2 mm,
incisa con smalto

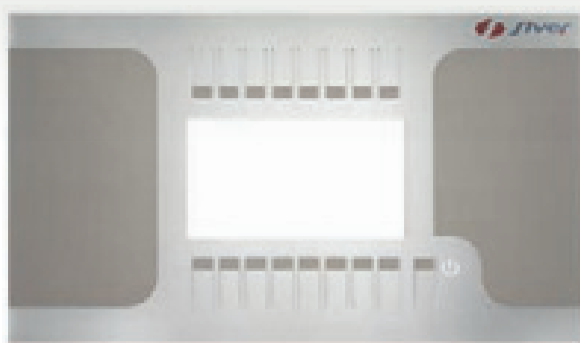

es. 380

Pannello in acciaio satinato
mm 290 x 170 x 3 con stampa serigrafica



es. 381

Esempi di piastre in alluminio anodizzato
argento e acciaio satinato h. 170 mm ca.



Timbri



BE1

Bollatore elettrico per impressione a caldo
500 watt



es. 344

Timbri per impressione a caldo
mm 28 x 25
mm 37 x 37

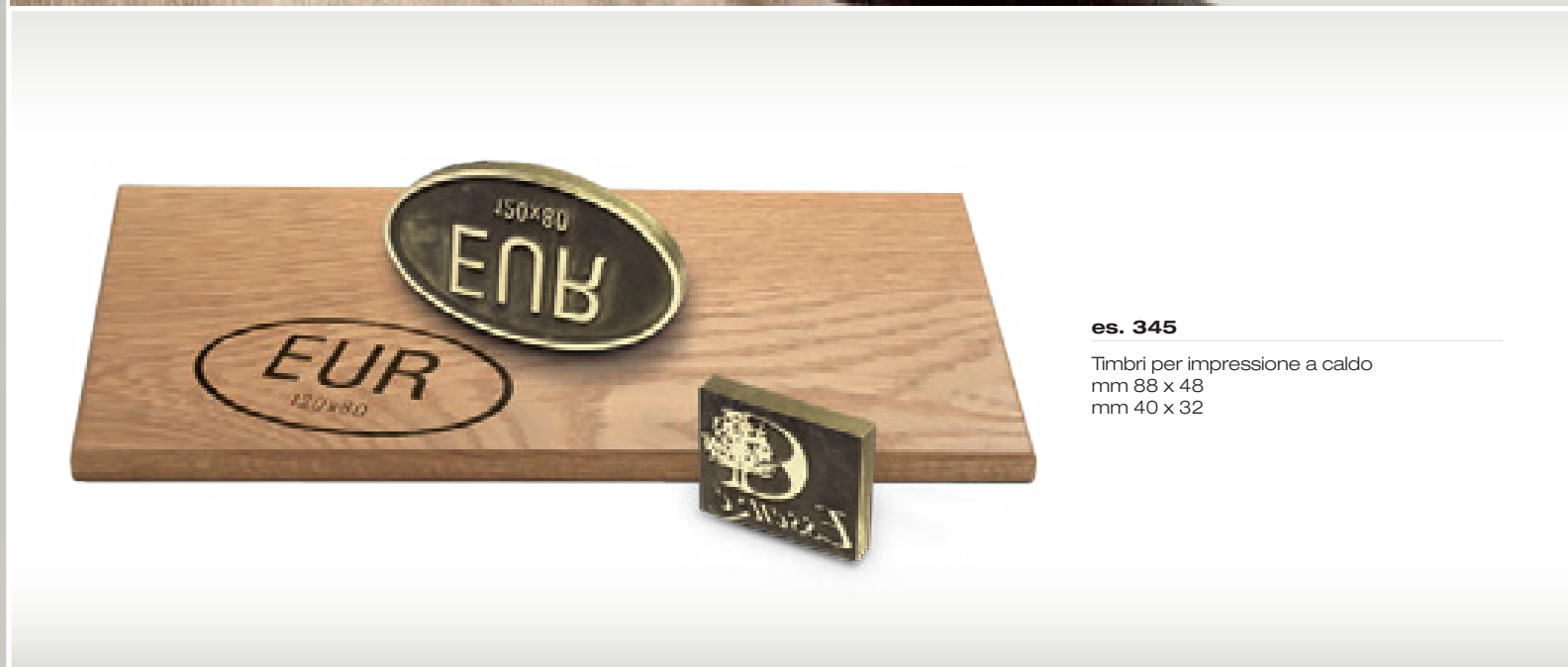

es. 345

Timbri per impressione a caldo
mm 88 x 48
mm 40 x 32

ML 85

Manico in legno - Lunghezza 85 mm



TIM - Disco per timbro in ottone satinato neutro

TIM1 - ø 40 mm Sp. 8 mm

TIM2 - ø 35 mm Sp. 8 mm

TIM3 - ø 30 mm Sp. 8 mm



es. 346

Timbri in ottone



es. 347

Sigilli in ottone per ceramica



Timbri



es. 348

Timbro in polipropilene per uso alimentare



es. 349

Punzoni in acciaio temprato



es. 350

Timbro componibile in ottone
mm 70x50 Sp. 20



es. 351

punzone in acciaio temprato con esempio
marchiatura su pomello in ottone

Pulsantiere e buche lettere

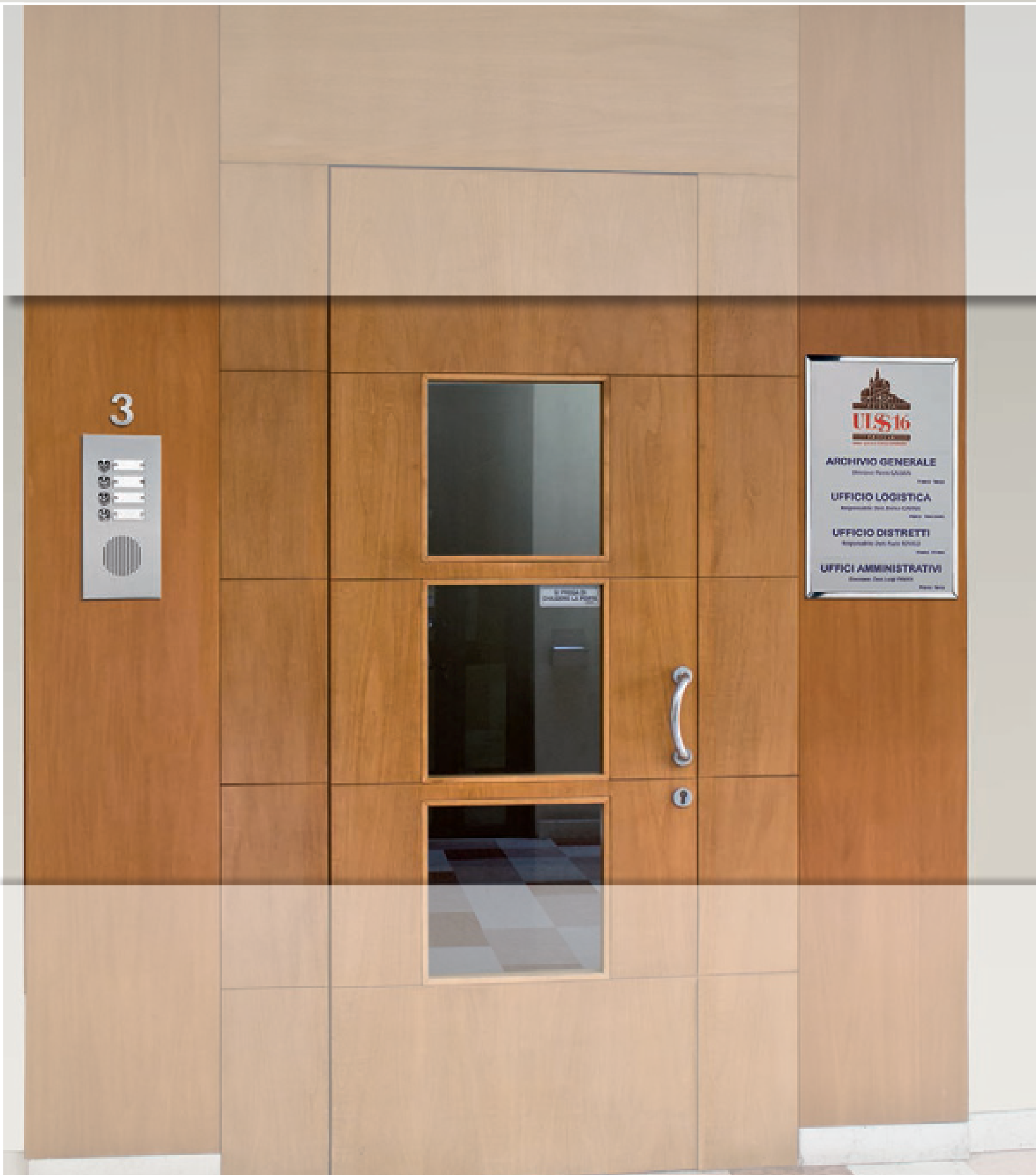

Campanelli



CAM1 - Campanello ottone satinato con taglio lucido, pulsante ottone e asola lucida con opalino

CAM1 - 110 x 70 mm ottone Sp.3



CAM2 - Campanello ottone satinato con taglio lucido, pulsante ottone e asola lucida con opalino

CAM2 - 120 x 80 mm ottone Sp.3



CAM3 - Campanello ottone satinato con taglio lucido, pulsante ottone e asola lucida con opalino

CAM3 - 145 x 55 mm ottone Sp.3



CAM4 - Campanello ottone satinato con taglio lucido, pulsante ottone e asola lucida con opalino

CAM4 - 145 x 55 mm ottone Sp.3



CAM5 - Campanello ottone satinato con taglio lucido, pulsante ottone e asola lucida con opalino

CAM5 - 145 x 75 mm ottone Sp.3



CAM6 - Campanello ottone satinato con taglio lucido, pulsante ottone e asola lucida con opalino

CAM6 - 120 x 80 mm ottone Sp.3

Campanelli

CPO - Campanello ottone lucido e pulsante ottone

- CPO1** - 145 x 75 mm ottone Sp.3
CPO2 - 90 x 50 mm ottone Sp.3

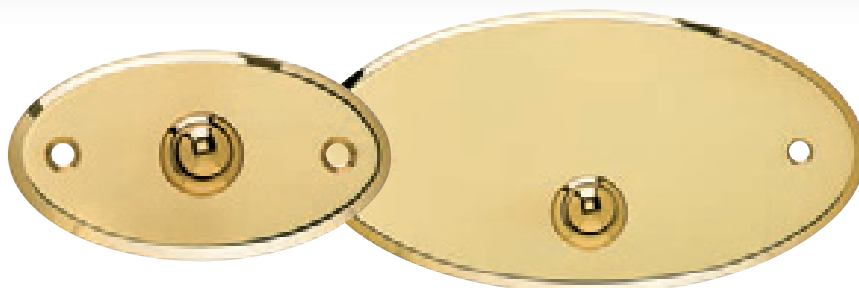

CPO - Campanello ottone lucido e pulsante ottone

- CPO3** - ø 100 mm ottone Sp.3
CPO4 - ø 70 mm ottone Sp.3

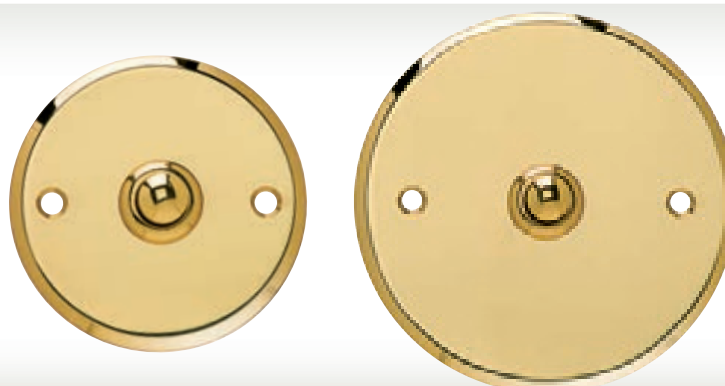

CPO - Campanello ottone lucido e pulsante ottone

- CPO5** - 145 x 55 mm ottone Sp.3
CPO6 - 90 x 45 mm ottone Sp.3

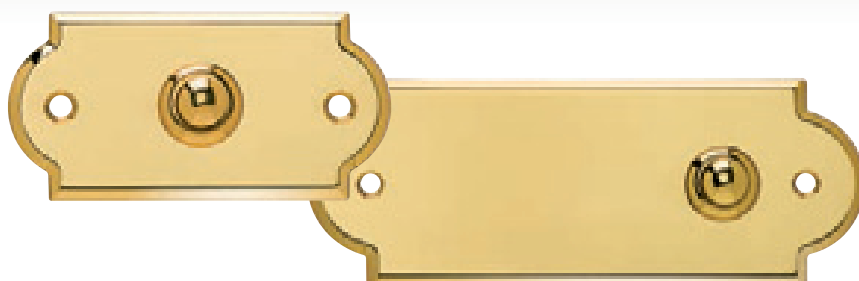

CPO - Campanello ottone lucido e pulsante ottone

- CPO7** - 120 x 75 mm ottone Sp.3
CPO8 - 90 x 60 mm ottone Sp.3

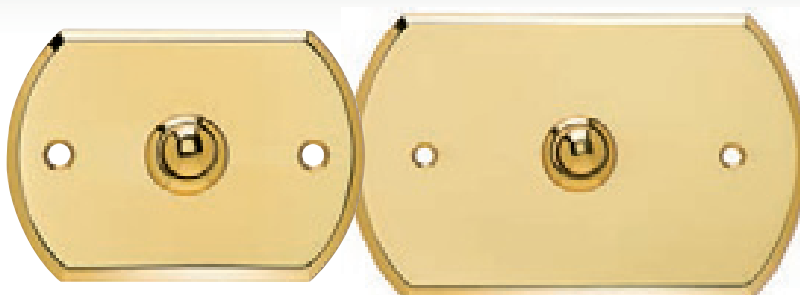

CP - Campanello in ottone verniciato grigio micaceo, pulsante ottone

- CP4** - 120 x 75 mm ottone Sp.3

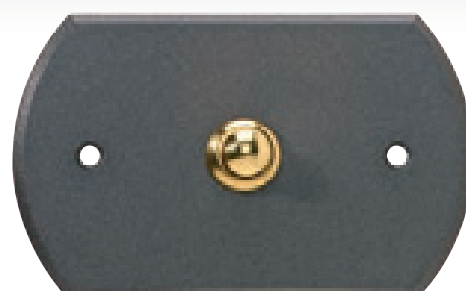

Campanelli



CP - Campanello concavo ottone lucido

CP1 - \varnothing 68 mm ottone

CP2 - \varnothing 58 mm ottone

CP3 - \varnothing 43 mm ottone



Campanello ottone fuso lucido

CP5 - 70 x 70 mm ottone

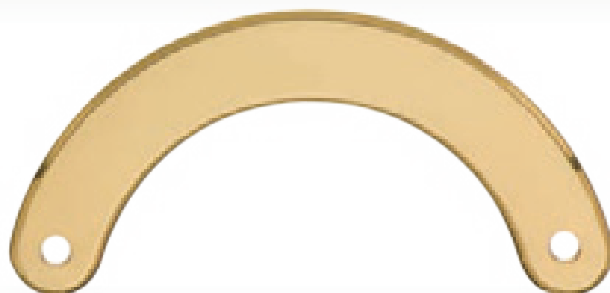

LU - Lunetta ottone lucido

LU1 - 120 x 18 mm ottone Sp.2

LU2 - 100 x 16 mm ottone Sp.2

LU3 - 75 x 12 mm ottone Sp.2



TOS - Targhetta sagomata ottone satinato

TOS - 135 x 22 mm Sp. 0,7



PULS4



PULS2



PULS5



PULS4C



PULS3



PULS5C

PULS - Pulsante ottone

PULS4 - \varnothing 15 mm (foro) ottone lucido

PULS4C - \varnothing 15 mm (foro) ottone cromato

PULS2 - \varnothing 15 mm (foro) ottone lucido

PULS3 - \varnothing 15 mm (foro) ottone cromato

PULS5 - \varnothing 15 mm (foro) ottone lucido

PULS5C - \varnothing 15 mm (foro) ottone lucido

Numeri civici

CVO - Targa per numero civico ottone bordo lucido, angoli arrotondati

CVO - 140 x 100 mm ottone Sp.3

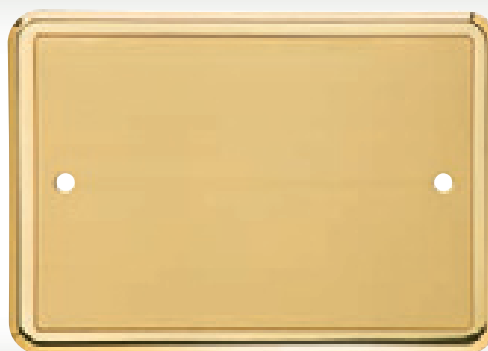

CVB - Targa per numero civico ottone verniciato grigio micaceo, angoli arrotondati

CVB - 140 x 100 mm ottone Sp.3



CV1 - Targa ottone bordo lucido mm 140 x 100 x 3 con angoli arrotondati con un numero ottone lucido applicato h. 50 mm Sp. 3

CVB1 - Targa ottone verniciato grigio micaceo mm 140 x 100 x 3 con angoli arrotondati con un numero ottone lucido applicato h. 50 mm Sp. 3



esempio CV1

CV2 - Targa ottone bordo lucido mm 140 x 100 x 3 con angoli arrotondati con 2 numeri ottone lucido applicati h. 50 mm Sp. 3

CVB2 - Targa ottone verniciato grigio micaceo mm 140 x 100 x 3 con angoli arrotondati con 2 numeri ottone lucido applicati h. 50 mm Sp. 3



esempio CVB2

CV3 - Targa ottone bordo lucido mm 140 x 100 x 3 con angoli arrotondati con 3 numeri ottone lucido applicati h. 50 mm Sp. 3

CVB3 - Targa ottone verniciato grigio micaceo mm 140 x 100 x 3 con angoli arrotondati con 3 numeri ottone lucido applicati h. 50 mm Sp. 3



esempio CV3

Buche lettere



BO1 - Buca lettere in ottone bordo lucido
anta lucida a tirare

BO1 - 325 x 170 mm ottone



BO2 - Buca lettere in ottone satinato
anta lucida a tirare

BO2 - 330 x 100 mm ottone



BO3 - Buca lettere in ottone bordo lucido
anta lucida a tirare

BO3 - 280 x 90 mm ottone



BO5 - Buca lettere in ottone satinato
anta satinata a spingere

BO5 - 330 x 100 mm ottone

Buche lettere

BO6 - Buca lettere in ottone bordo lucido, angoli arrotondati, anta lucida a spingere

BO6 - 270 x 100 mm ottone

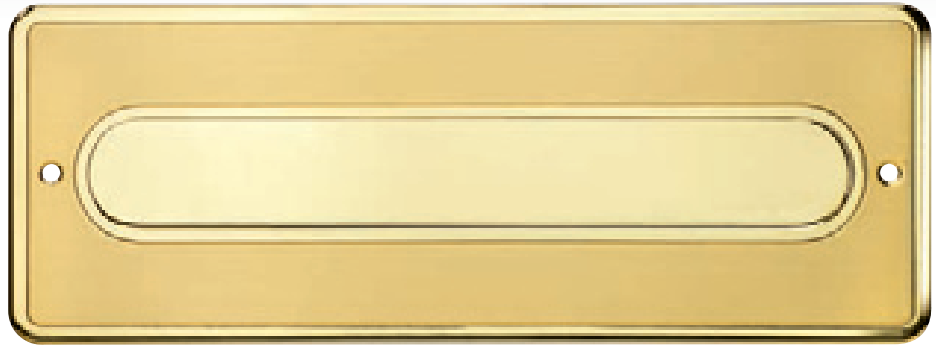

BO7 - Buca lettere in ottone bordo lucido anta lucida a spingere

BO7 - 280 x 90 mm ottone



BO8 - Buca lettere in ottone verniciato grigio micaceo anta lucida a spingere

BO8 - 280 x 90 mm ottone



BO10 - Buca lettere in alluminio anodizzato argento taglio lucido anta a spingere

BO8 - 280 x 90 mm alluminio



Pulsantiere

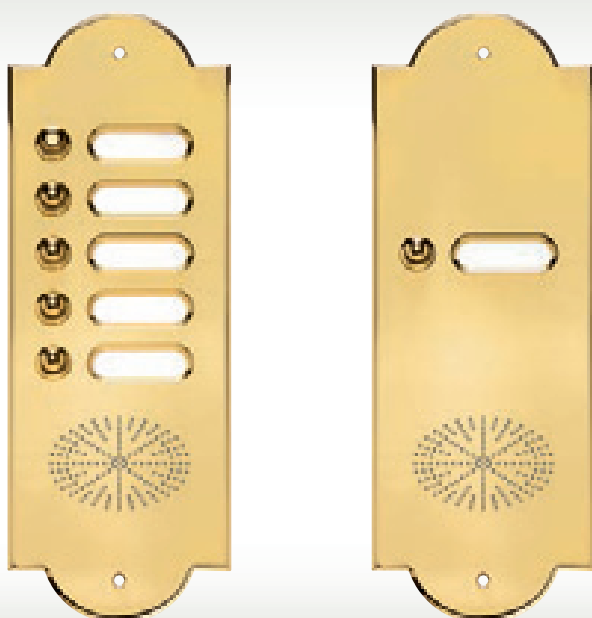

CTL - Pulsantiera in ottone lucido e griglia traforata su piastra con pulsanti e asola lucida con opalino

CTL1 - 1 pulsante - 340 x 120 mm Sp.3

CTL2 - 2 pulsanti - 340 x 120 mm Sp.3

CTL3 - 3 pulsanti - 340 x 120 mm Sp.3

CTL4 - 4 pulsanti - 340 x 120 mm Sp.3

CTL5 - 5 pulsanti - 340 x 120 mm Sp.3

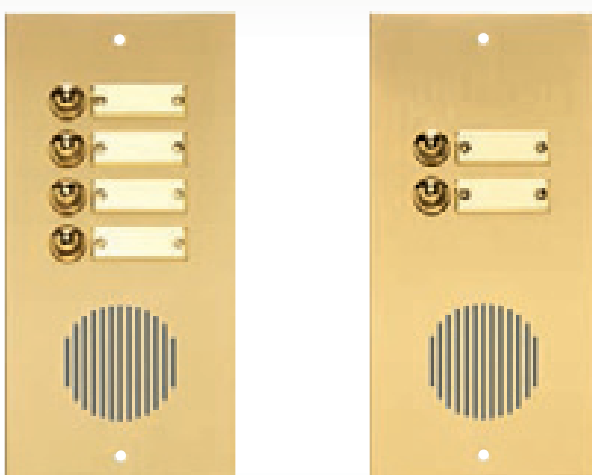

CTE - Pulsantiera in ottone satinato e griglia traforata su piastra con pulsanti e targhetta ottone lucido

CTE1 - 1 pulsante - 250 x 120 mm Sp.3

CTE2 - 2 pulsanti - 250 x 120 mm Sp.3

CTE3 - 3 pulsanti - 250 x 120 mm Sp.3

CTE4 - 4 pulsanti - 250 x 120 mm Sp.3

CTE5 - 5 pulsanti - 250 x 120 mm Sp.3



CTB - Pulsantiera in ottone verniciato grigio micaceo e griglia traforata su piastra con pulsanti ottone lucido e asola con opalino

CTB1 - 1 pulsante - 150 x 210 mm Sp.3

CTB2 - 2 pulsanti - 150 x 240 mm Sp.3

CTB3 - 3 pulsanti - 150 x 270 mm Sp.3

CTB4 - 4 pulsanti - 150 x 300 mm Sp.3

Pulsantiere

CTO - Pulsantiera in ottone satinato bordo lucido e griglia traforata su piastra con pulsanti e asola lucida con opalino

- CTO1** - 1 pulsante - 150 x 210 mm Sp.3
- CTO2** - 2 pulsanti - 150 x 240 mm Sp.3
- CTO3** - 3 pulsanti - 150 x 270 mm Sp.3
- CTO4** - 4 pulsanti - 150 x 300 mm Sp.3

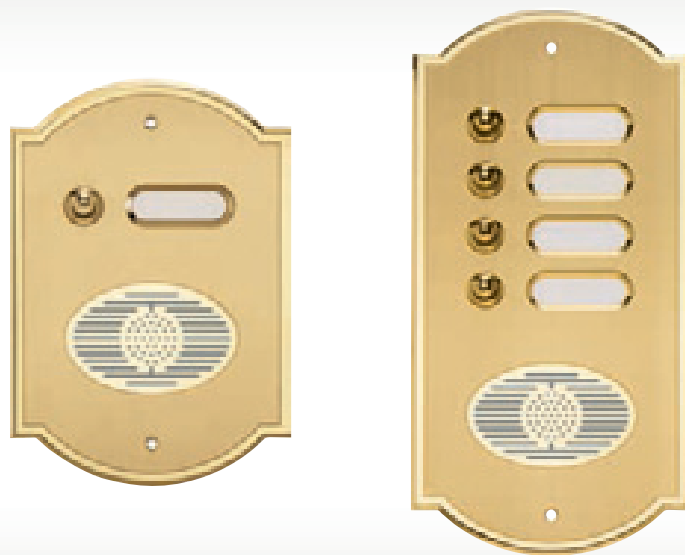

CTS - Pulsantiera in ottone satinato bordo lucido con griglia traforata su piastra con pulsanti e targhetta mod. OPA5

- CTS1** - 1 pulsante - 180 x 210 mm Sp.3
- CTS2** - 2 pulsanti - 180 x 235 mm Sp.3
- CTS3** - 3 pulsanti - 180 x 265 mm Sp.3



CTN - Pulsantiera in ottone satinato bordo lucido e griglia traforata su piastra con soggetto "quadrifoglio" con pulsanti e asola lucida con opalino

- CTN1** - 1 pulsante - 100 x 180 mm Sp.3
- CTN2** - 2 pulsanti - 100 x 210 mm Sp.3
- CTN3** - 3 pulsanti - 100 x 240 mm Sp.3

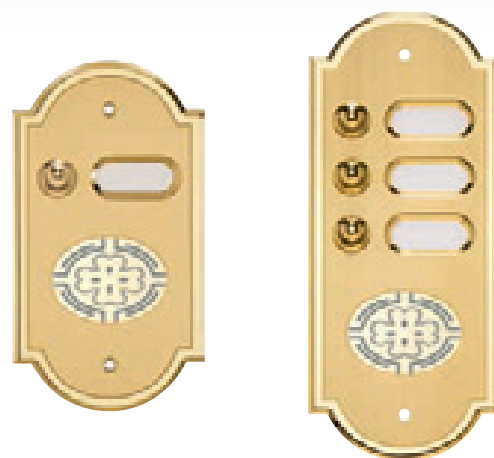

Pulsantiere – accessori

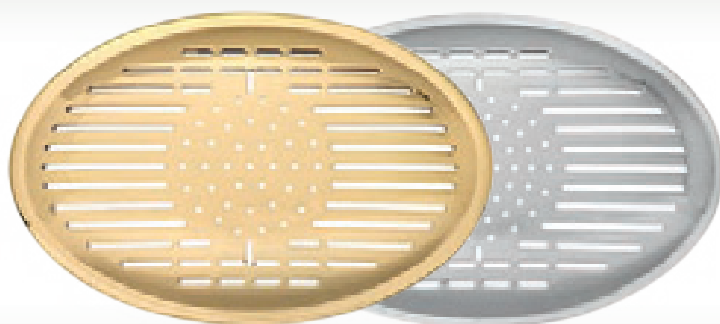

GRI - Griglia ottone lucido bombata

GRI1 - 110 x 75 mm

GRI2 - 87 x 57 mm

GRIC - Griglia ottone cromato bombata

GRI1C - 110 x 75 mm

GRI2C - 87 x 57 mm

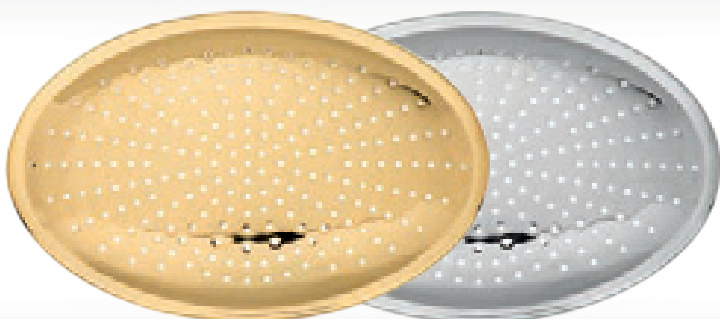

GRI - Griglia ottone lucido bombata

GRI3 - 110 x 75 mm

GRI4 - 87 x 57 mm

GRIC - Griglia ottone cromato bombata

GRI3C - 110 x 75 mm

GRI4C - 87 x 57 mm



OPA - Targhetta opalino

OPA1 - 70 x 20 mm

OPA2 - 52 x 24 mm

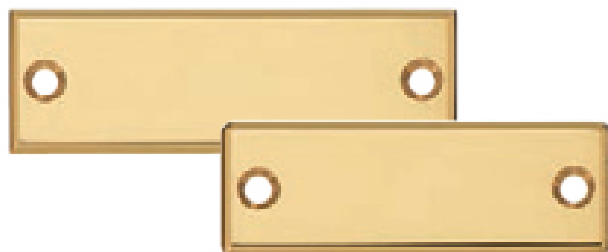

OPA - Targhetta ottone lucido

OPA3 - 60 x 20 mm

OPA4 - 50 x 18 mm

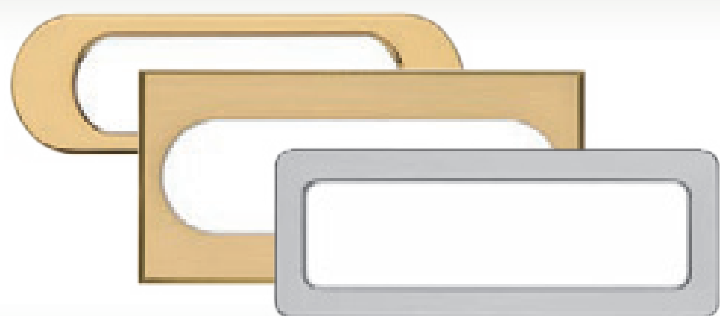

OPA5 - Targhetta ottone lucido con opalino

OPA5 - 70 x 22 mm

OPA6 - Targhetta ottone satinato con metacrilato per inserimento cartoncino

OPA6 - 70 x 34 mm

OPA7 - Targhetta ottone lucido con metacrilato per inserimento cartoncino

OPA7 - 65 x 25 mm

Pulsantiere - esempi personalizzati

es. 382

Pulsantiera in ottone con fondo inciso bocciardato e brunito, cornice e grafica a rilievo lucido, con campanello concavo mm 160 x 400 x 5

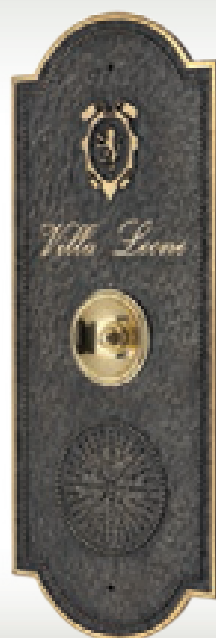

es. 383

Buca lettere in ottone con fondo inciso bocciardato e brunito, cornice e grafica a rilievo lucido, anta a spingere mm 325 x 170 x 5



es. 384

Buca lettere scatola in ottone grigio micaceo con anta a spingere sul lato superiore, porta sul fronte, incisione e smalto bianco mm 220 x 310, scatola mm 100



Pulsantiere - esempi personalizzati

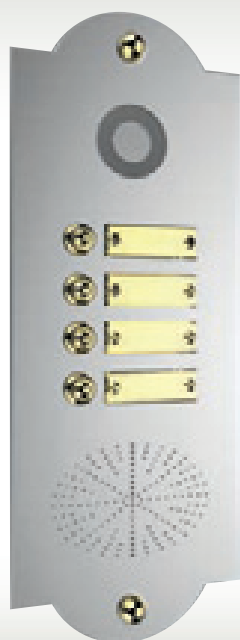

es. 385

Pulsantiera in acciaio lucido, con griglia, video, 4 pulsanti con targhetta in ottone lucido, mm 150 x 390 x 3



es. 386

Pulsantiera scatolata in ottone lucido con griglia, video, 2 pulsanti targhetta mod. OPA7 mm 180 x 300, scatola mm 25

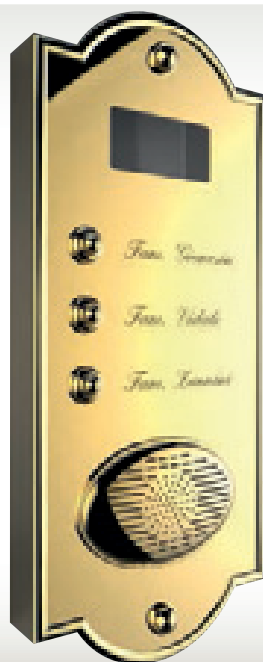

es. 387

Pulsantiera scatolata in ottone lucido con cornicetta applicata, griglia, video, 3 pulsanti, incisione su piastra con smalto, mm 160 x 370, scatola mm 25

Pulsantiere - esempi personalizzati

es. 388

Pulsantiera in ottone con fondo inciso brunito e rilievo satinato, con video e pulsante con targhetta in ottone lucido
mm 350 x 390 x 5



es. 389

Pulsantiera in alluminio verniciato grigio micaceo con griglia, video, buca lettere, porta, pulsanti e borchie cromate, incisioni su piastra mm 420 x 350 x 3



es. 390

Pulsantiera in alluminio verniciato bianco con griglia, video, buca lettere, pulsante con targhetta e tettuccio.
Stampa digitale e vernice di protezione
mm 500 x 350 x 3



Pulsantiere - esempi personalizzati



es. 391

Pulsantiera in ottone verniciato verde micaceo con bordo lucido, griglia art. GR11, campanello art. CP5 e incisione su piastra mm 160 x 290 x 3



es. 392

Cassetta ritiro posta in acciaio lucido sciolato con porta in acciaio satinato mm 280 x 360 x 3



es. 393

Pulsantiera in acciaio lucido/satinato con griglia, video, pulsante con opalino, anta a spingere mm 350 x 510 x 3





PLP - Pergamena 4 ricci alluminio bianco

- PLP1** - 200 x 150 mm
- PLP2** - 180 x 130 mm
- PLP3** - 160 x 120 mm
- PLP4** - 230 x 180 mm

PLA - Pergamena 4 ricci alluminio argento

- PLA1** - 200 x 150 mm
- PLA2** - 180 x 130 mm
- PLA3** - 160 x 120 mm
- PLA4** - 230 x 180 mm

PLO - Pergamena 4 ricci alluminio oro

- PLO1** - 200 x 150 mm
- PLO2** - 180 x 130 mm
- PLO3** - 160 x 120 mm
- PLO4** - 230 x 180 mm



GRP - Pergamena 6 ricci alluminio bianco

- GRP1** - 230 x 180 mm
- GRP2** - 200 x 150 mm
- GRP3** - 180 x 130 mm

GRA - Pergamena 6 ricci alluminio argento

- GRA1** - 230 x 180 mm
- GRA2** - 200 x 150 mm
- GRA3** - 180 x 130 mm

GRO - Pergamena 6 ricci alluminio oro

- GRO1** - 230 x 180 mm
- GRO2** - 200 x 150 mm
- GRO3** - 180 x 130 mm

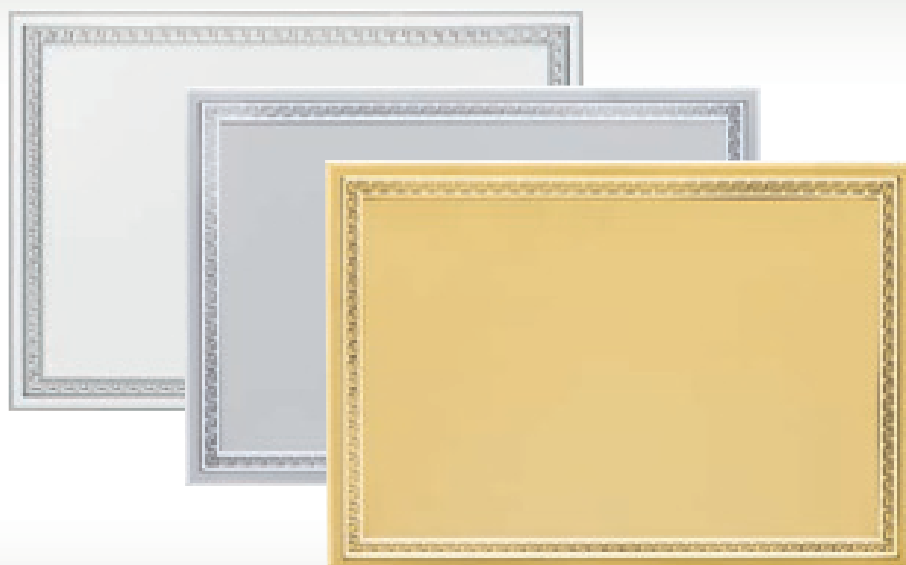

IMPL - Targa alluminio bianco mod. Impero

- IMPL1** - 200 x 150 mm
- IMPL2** - 170 x 120 mm
- IMPL3** - 140 x 100 mm

IMLA - Targa alluminio argento mod. Impero

- IMLA1** - 200 x 150 mm
- IMLA2** - 170 x 120 mm
- IMLA3** - 140 x 100 mm

IMLO - Targa alluminio oro mod. Impero

- IMLO1** - 200 x 150 mm
- IMLO2** - 170 x 120 mm
- IMLO3** - 140 x 100 mm

BPP - Targa alluminio bianco bordo lucido piatto

- BPP1** - 200 x 150 mm
- BPP2** - 170 x 120 mm
- BPP3** - 140 x 100 mm

BPA - Targa alluminio argento bordo lucido piatto

- BPA1** - 200 x 150 mm
- BPA2** - 170 x 120 mm
- BPA3** - 140 x 100 mm

BPO - Targa alluminio oro bordo lucido piatto

- BPO1** - 200 x 150 mm
- BPO2** - 170 x 120 mm
- BPO3** - 140 x 100 mm



BLLP - Targa alluminio bianco bordo sbalzato

- BLLP1** - 200 x 150 mm
- BLLP2** - 170 x 120 mm
- BLLP3** - 140 x 100 mm

BLLA - Targa alluminio argento bordo sbalzato

- BLLA1** - 200 x 150 mm
- BLLA2** - 170 x 120 mm
- BLLA3** - 140 x 100 mm

BLLO - Targa alluminio oro bordo sbalzato

- BLLO1** - 200 x 150 mm
- BLLO2** - 170 x 120 mm
- BLLO3** - 140 x 100 mm



TPP - Targa pallini alluminio bianco

- TPP1** - 200 x 150 mm
- TPP2** - 170 x 120 mm
- TPP3** - 140 x 100 mm

TPA - Targa pallini alluminio argento

- TPA1** - 200 x 150 mm
- TPA2** - 170 x 120 mm
- TPA3** - 140 x 100 mm

TPO - Targa pallini alluminio oro

- TPO1** - 200 x 150 mm
- TPO2** - 170 x 120 mm
- TPO3** - 140 x 100 mm

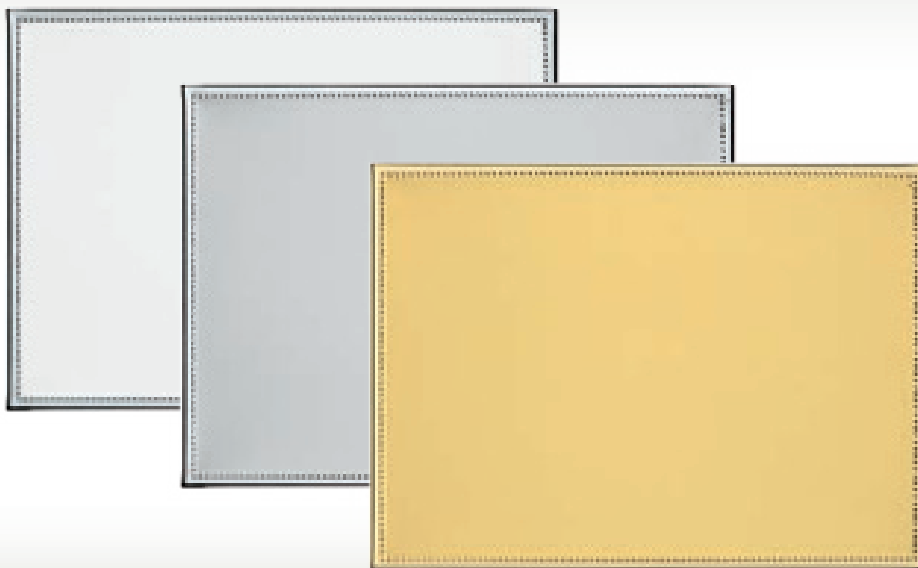

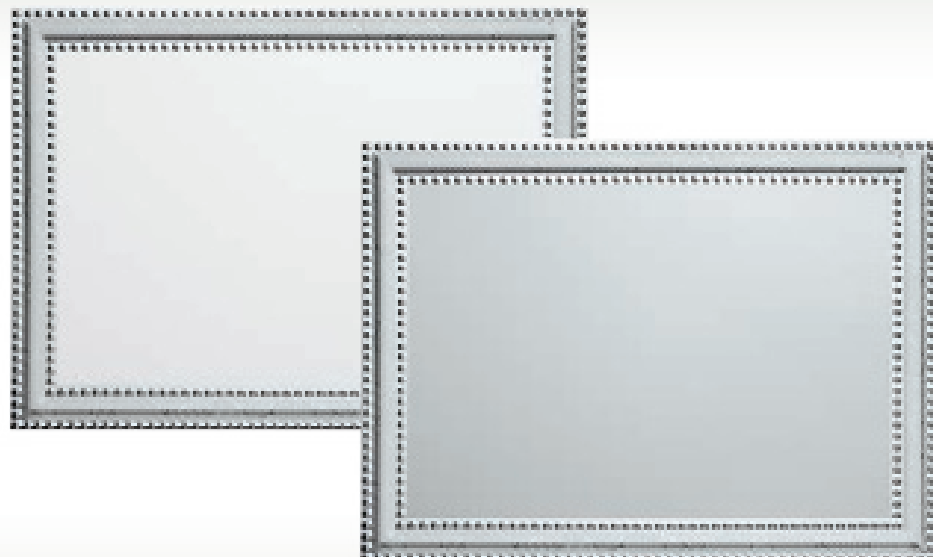

BBP - Targa bordo pallini e decoro serigrafato alluminio bianco

BBP1 - 200 x 150 mm

BBP2 - 170 x 120 mm

BBP3 - 140 x 100 mm

BBA - Targa bordo pallini e decoro serigrafato alluminio argento

BBA1 - 200 x 150 mm

BBA2 - 170 x 120 mm

BBA3 - 140 x 100 mm

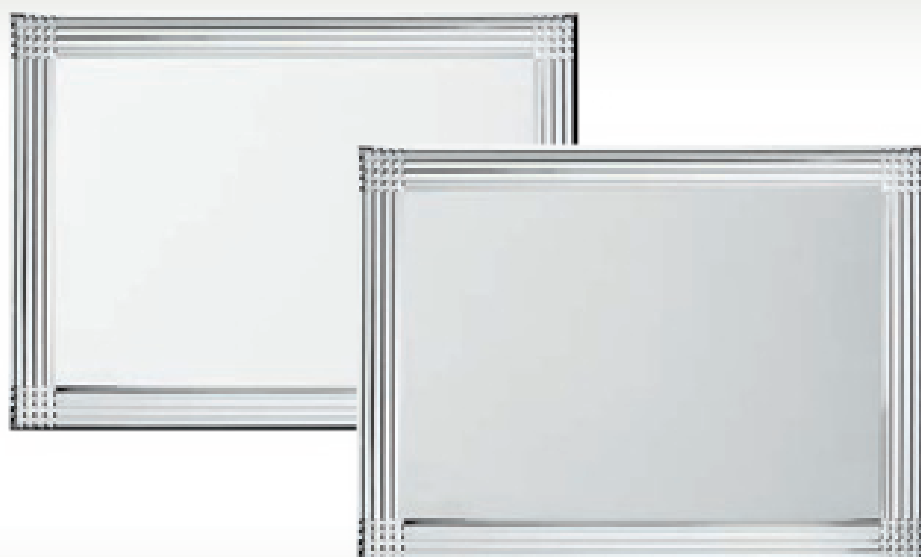

5FP - Targa bordo lucido 5 fili alluminio bianco

5FP1 - 200 x 150 mm

5FP2 - 170 x 120 mm

5FP3 - 140 x 100 mm

5FA - Targa bordo lucido 5 fili alluminio argento

5FA1 - 200 x 150 mm

5FA2 - 170 x 120 mm

5FA3 - 140 x 100 mm



TEXA - Targa alluminio argento bordo decoro serigrafato

TEXA1 - 200 x 150 mm

TEXA2 - 170 x 120 mm

TEXA3 - 140 x 100 mm

Targhe da premiazione in alluminio **transfer**

SCUDOP - Scudo alluminio bianco bordo sbalzato

SCUDOP1 - 160 x 185 mm

SCUDOP2 - 140 x 165 mm

SCUDOP3 - 120 x 145 mm

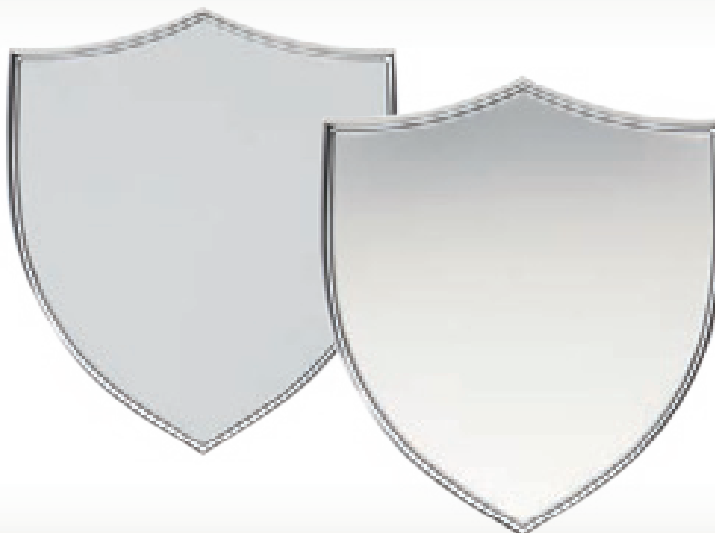

SCUDOA - Scudo alluminio argento bordo sbalzato

SCUDOA1 - 160 x 185 mm

SCUDOA2 - 140 x 165 mm

SCUDOA3 - 120 x 145 mm

DAP - Disco alluminio bianco bordo lucido

DAP160 - ø 160 mm

DAP140 - ø 140 mm

DAP110 - ø 110 mm

DAP90 - ø 90 mm

DAP70 - ø 70 mm



DAA - Disco alluminio argento bordo lucido

DAA160 - ø 160 mm

DAA140 - ø 140 mm

DAA110 - ø 110 mm

DAA90 - ø 90 mm

DAA70 - ø 70 mm

DBA - Disco alluminio argento bordo sbalzato lucido

DBA140 - ø 140 mm

DBA110 - ø 110 mm





PLPS - Pergamena 4 ricci alluminio bianco per sublimazione

- PLPS1** - 200 x 150 mm
- PLPS2** - 180 x 130 mm
- PLPS3** - 160 x 120 mm
- PLPS4** - 230 x 180 mm

PLAS - Pergamena 4 ricci alluminio argento per sublimazione

- PLAS1** - 200 x 150 mm
- PLAS2** - 180 x 130 mm
- PLAS3** - 160 x 120 mm
- PLAS4** - 230 x 180 mm

PLOS - Pergamena 4 ricci alluminio oro per sublimazione

- PLOS1** - 200 x 150 mm
- PLOS2** - 180 x 130 mm
- PLOS3** - 160 x 120 mm
- PLOS4** - 230 x 180 mm



GRPS - Pergamena 6 ricci alluminio bianco per sublimazione

- GRPS1** - 230 x 180 mm
- GRPS2** - 200 x 150 mm
- GRPS3** - 180 x 130 mm

GRAS - Pergamena 6 ricci alluminio argento per sublimazione

- GRAS1** - 230 x 180 mm
- GRAS2** - 200 x 150 mm
- GRAS3** - 180 x 130 mm

GROS - Pergamena 6 ricci alluminio oro per sublimazione

- GROS1** - 230 x 180 mm
- GROS2** - 200 x 150 mm
- GROS3** - 180 x 130 mm



BPPS - Targa alluminio bianco bordo lucido piatto per sublimazione

- BPPS1** - 200 x 150 mm
- BPPS2** - 170 x 120 mm
- BPSS3** - 140 x 100 mm

BPAS - Targa alluminio argento bordo lucido piatto per sublimazione

- BPAS1** - 200 x 150 mm
- BPAS2** - 170 x 120 mm
- BPAS3** - 140 x 100 mm

BBAS - Targa bordo pallini e decoro serigrafato alluminio argento per sublimazione

- BBAS1** - 200 x 150 mm
- BBAS2** - 170 x 120 mm
- BBAS3** - 140 x 100 mm

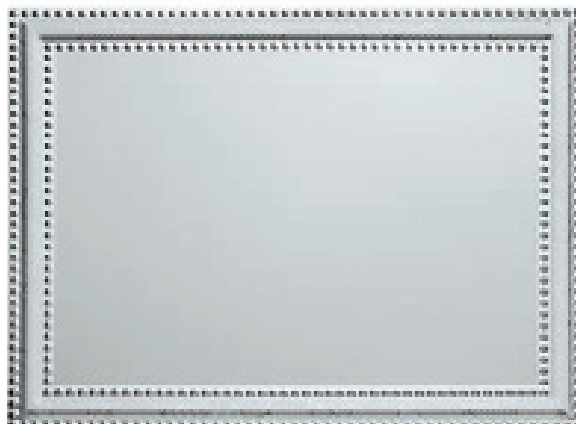

5FPS - Targa bordo lucido 5 fili alluminio bianco per sublimazione

- 5FPS1** - 200 x 150 mm
- 5FPS2** - 170 x 120 mm
- 5FPS3** - 140 x 100 mm

5FAS - Targa bordo lucido 5 fili alluminio argento per sublimazione

- 5FAS1** - 200 x 150 mm
- 5FAS2** - 170 x 120 mm
- 5FAS3** - 140 x 100 mm



TEXAS - Targa alluminio argento bordo decoro per sublimazione

- TEXAS1** - 200 x 150 mm
- TEXAS2** - 170 x 120 mm
- TEXAS3** - 140 x 100 mm



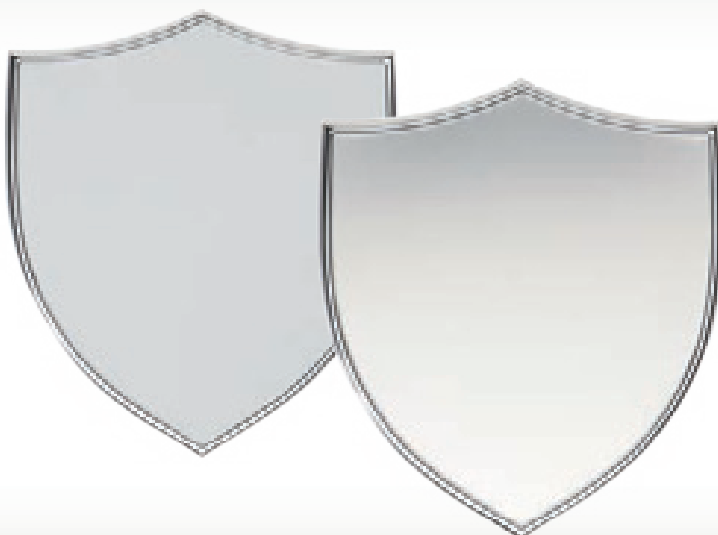

SCUDOP/S - Scudo alluminio bianco bordo sbalzato per sublimazione

SCUDOP1S - 160 x 185 mm

SCUDOP2S - 140 x 165 mm

SCUDOP3S - 120 x 145 mm

SCUDOAS - Scudo alluminio argento bordo sbalzato per sublimazione

SCUDOAS1S - 160 x 185 mm

SCUDOAS2S - 140 x 165 mm

SCUDOAS3S - 120 x 145 mm



DAP/S - Disco alluminio bianco bordo lucido per sublimazione

DAP160S - ø 160 mm

DAP140S - ø 140 mm

DAP110S - ø 110 mm

DAP90S - ø 90 mm

DAP70S - ø 70 mm

DAA/S - Disco alluminio argento bordo lucido per sublimazione

DAA160S - ø 160 mm

DAA140S - ø 140 mm

DAA110S - ø 110 mm

DAA90S - ø 90 mm

DAA70S - ø 70 mm



DBA/S - Disco alluminio argento bordo sbalzato per sublimazione

DBA140S - ø 140 mm

DBA110S - ø 110 mm

Targhe da premiazione in ottone

PGS - Pergamena ottone silver

- PGS1** - 200 x 150 mm
- PGS2** - 180 x 130 mm
- PGS3** - 160 x 120 mm
- PGS4** - 255 x 180 mm

PGO - Pergamena ottone

- PGO1** - 200 x 150 mm
- PGO2** - 180 x 130 mm
- PGO3** - 160 x 120 mm
- PGO4** - 255 x 180 mm



PGRS - Pergamena ottone silver

- PGRS1** - 230 x 180 mm
- PGRS2** - 200 x 150 mm
- PGRS3** - 180 x 130 mm

PGRO - Pergamena ottone

- PGRO1** - 230 x 180 mm
- PGRO2** - 200 x 150 mm
- PGRO3** - 180 x 130 mm



DISCHI

- 33-S** - Disco 33 giri in ottone silver ø 300 mm
- 33-O** - Disco 33 giri in ottone ø 300 mm
- 45-S** - Disco 45 giri in ottone silver ø 175 mm
- 45-O** - Disco 45 giri in ottone ø 175 mm
- CD-S** - CD in ottone silver ø 120 mm
- CD-O** - CD in ottone ø 120 mm



Targhe da premiazione in ottone



SBLS - Targa con base in alluminio lucido e inserto in ottone silver

SBLS1 - 200 x 150 mm

SBLS2 - 170 x 120 mm

SBLS3 - 140 x 100 mm

SBLS4 - 240 x 180 mm

SBLO - Targa con base in alluminio oro lucido e inserto in ottone satinato

SBLO1 - 200 x 150 mm

SBLO2 - 170 x 120 mm

SBLO3 - 140 x 100 mm

SBLO4 - 240 x 180 mm



IMS - Targa ottone silver mod. Impero

IMS1 - 200 x 150 mm

IMS2 - 170 x 120 mm

IMS3 - 140 x 100 mm

IMO - Targa ottone mod. Impero

IMO1 - 200 x 150 mm

IMO2 - 170 x 120 mm

IMO3 - 140 x 100 mm

Targhe da premiazione in ottone

ZIGS - Targa in ottone silver mod. Zigrinata

- ZIGS1** - 200 x 150 mm
- ZIGS2** - 170 x 120 mm
- ZIGS3** - 140 x 100 mm

ZIGO - Targa in ottone mod. Zigrinata

- ZIGO1** - 200 x 150 mm
- ZIGO2** - 170 x 120 mm
- ZIGO3** - 140 x 100 mm



DIA/S - Targa ottone silver con bordo diamantato

- DIA1/S** - 240 x 180 mm
- DIA2/S** - 200 x 150 mm
- DIA3/S** - 180 x 130 mm
- DIA4/S** - 170 x 120 mm
- DIA5/S** - 150 x 100 mm
- DIA6/S** - 140 x 100 mm
- DIA7/S** - 130 x 90 mm

DIA/O - Targa ottone con bordo diamantato

- DIA1/O** - 240 x 180 mm
- DIA2/O** - 200 x 150 mm
- DIA3/O** - 180 x 130 mm
- DIA4/O** - 170 x 120 mm
- DIA5/O** - 150 x 100 mm
- DIA6/O** - 140 x 100 mm
- DIA7/O** - 130 x 90 mm

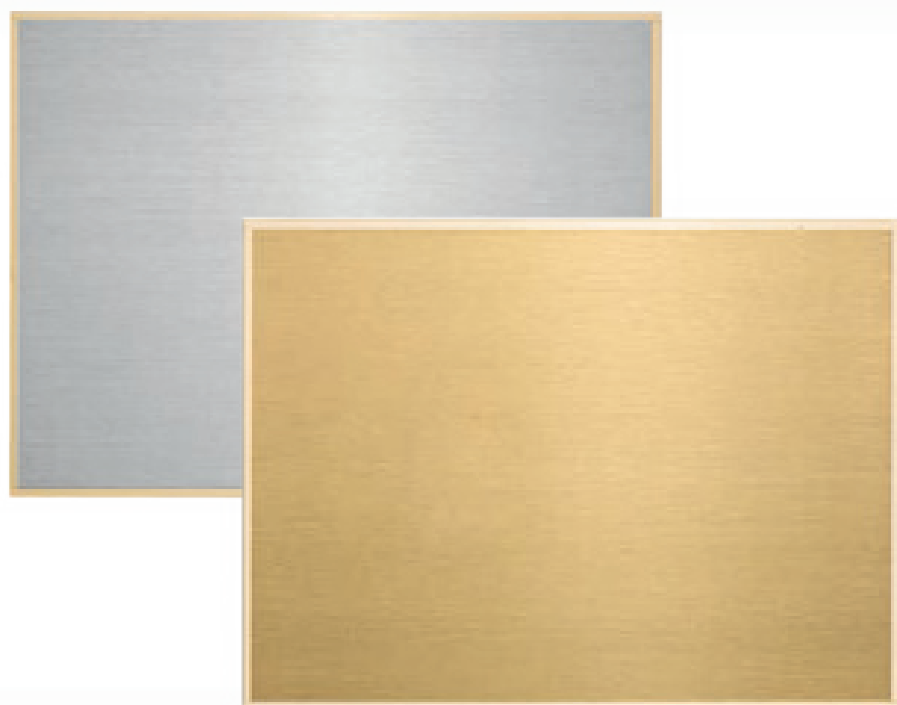

Targhette



TGS - Targhetta in ottone silver
bordo diamantato Sp. 0,5 mm (vedi listino)

TGO - Targhetta in ottone
bordo diamantato Sp. 0,5 mm (vedi listino)



TAA - Targhetta in alluminio argento
bordo diamantato Sp. 0,5 mm (vedi listino)

TAO - Targhetta in alluminio oro
bordo diamantato Sp. 0,5 mm (vedi listino)



SGS - Targhetta ottone silver sagomata

SGS1 - 75 x 20 mm Sp. 0,5

SGS2 - 59 x 13 mm Sp. 0,5

SGS3 - 45 x 10 mm Sp. 0,5

SGO - Targhetta ottone sagomata

SGO1 - 75 x 20 mm Sp. 0,5

SGO2 - 59 x 13 mm Sp. 0,5

SGO3 - 45 x 10 mm Sp. 0,5

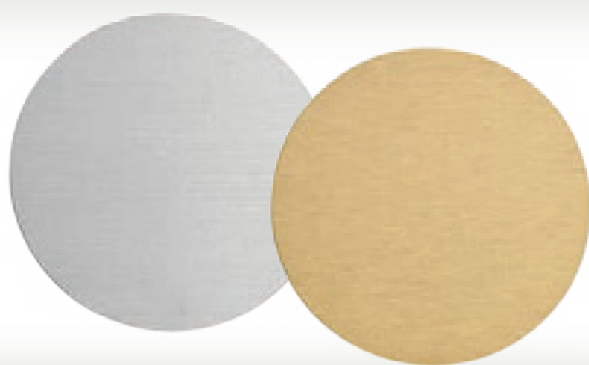

DO/S - Disco ottone silver satinato

DO1S - Ø 50 mm Sp. 0,5

DO2S - Ø 30 mm Sp. 0,5

DO - Disco ottone satinato

DO1 - Ø 50 mm Sp. 0,5

DO2 - Ø 30 mm Sp. 0,5

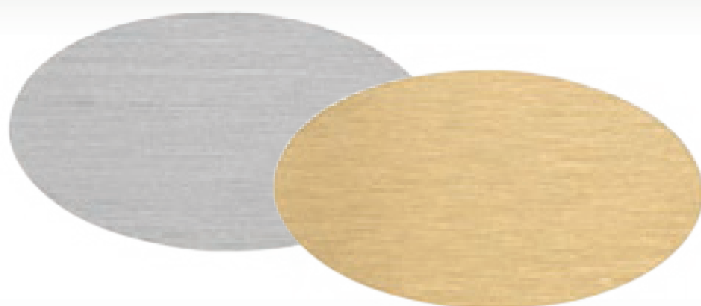

OV/S - Ovale ottone silver satinato

OV1S - 80 x 45 mm Sp. 0,5

OV2S - 60 x 35 mm Sp. 0,5

OV3S - 35 x 22 mm Sp. 0,5

OV - Ovale ottone satinato

OV1 - 80 x 45 mm Sp. 0,5

OV2 - 60 x 35 mm Sp. 0,5

OV3 - 35 x 22 mm Sp. 0,5

Targhe in argento 925‰

PLA - Pergamena in argento 925‰

PLA1 - 200 x 150 mm

PLA2 - 180 x 130 mm

PLA3 - 160 x 120 mm

PLA4 - 255 x 180 mm



PGRA - Pergamena in argento 925‰

PGRA1 - 230 x 180 mm

PGRA2 - 200 x 150 mm

PGRA3 - 180 x 130 mm

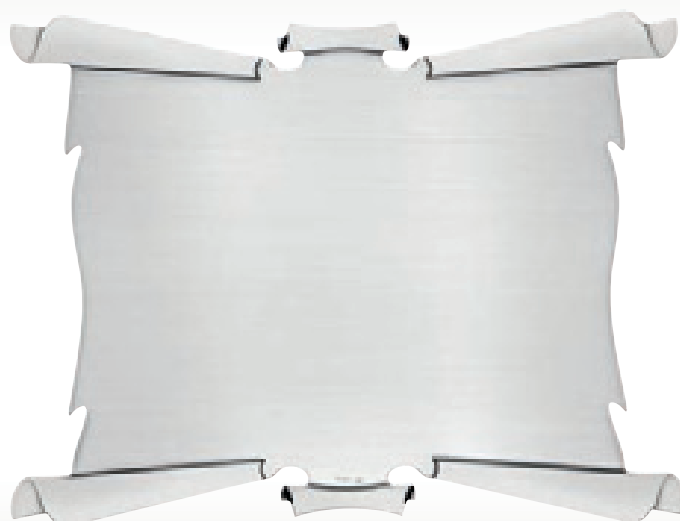

CD-A - CD in argento 925‰

CD-A - ø 120 mm



Targhe in argento 925‰



DIA/AR - Targa in argento 925‰ con bordo diamantato

DIA1/AR - 200 x 150 mm

DIA2/AR - 170 x 120 mm

DIA3/AR - 140 x 100 mm



BDA - Targa in argento 925‰ satinato con bordo sbalzato lucido

BDA1 - 200 x 150 x 0,4 mm

BDA2 - 170 x 120 x 0,4 mm

BDA3 - 140 x 100 x 0,4 mm

BDA4 - 240 x 180 x 0,4 mm



ZIGA - Targa in argento 925‰ mod. Zigrinata

ZIGA1 - 200 x 150 x 0,4 mm

ZIGA1 - 170 x 120 x 0,4 mm

ZIGA1 - 140 x 100 x 0,4 mm

Targhette in argento 925‰

TGA - Targhetta in argento 925‰
con bordo diamantato

- TGA126** - 120 x 60 x 0,4 mm
- TGA105** - 100 x 50 x 0,4 mm
- TGA840** - 80 x 40 x 0,4 mm
- TGA735** - 70 x 35 x 0,4 mm
- TGA630** - 60 x 30 x 0,4 mm
- TGA525** - 50 x 25 x 0,4 mm
- TGA420** - 40 x 20 x 0,4 mm



SGA - Targhetta in argento 925‰ sagomata

- SGA1** - 75 x 20 x 0,4 mm
- SGA2** - 59 x 13 x 0,4 mm
- SGA3** - 45 x 10 x 0,4 mm



OVA - Ovale in argento 925‰

- OVA1** - 80 x 45 x 0,4 mm
- OVA2** - 60 x 35 x 0,4 mm
- OVA3** - 35 x 22 x 0,4 mm



DA - Disco in argento 925‰

- DA1** - \varnothing 50 x 0,4 mm
- DA2** - \varnothing 30 x 0,4 mm



BTA - Biglietto in argento 925‰

- BTA1** - 85 x 54 x 0,4 mm
- BTA2** - 74 x 42 x 0,4 mm



Astucci e cavalletti per targhe da premiazione

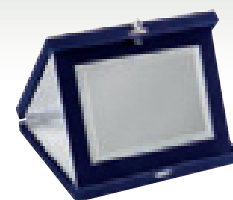

AV - Astuccio foderato velluto blu

AV1814 - 180 x 140 x 30 mm
AV2117 - 210 x 170 x 30 mm
AV2319 - 230 x 190 x 30 mm
AV2621 - 260 x 210 x 30 mm
AV3126 - 310 x 260 x 30 mm
(Disponibile anche in verticale)

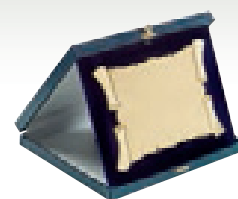

AE - Astuccio foderato carta blu

AE1814 - 180 x 140 x 30 mm
AE2117 - 210 x 170 x 30 mm
AE2319 - 230 x 190 x 30 mm
AE2621 - 260 x 210 x 30 mm
(Disponibile anche in verticale)

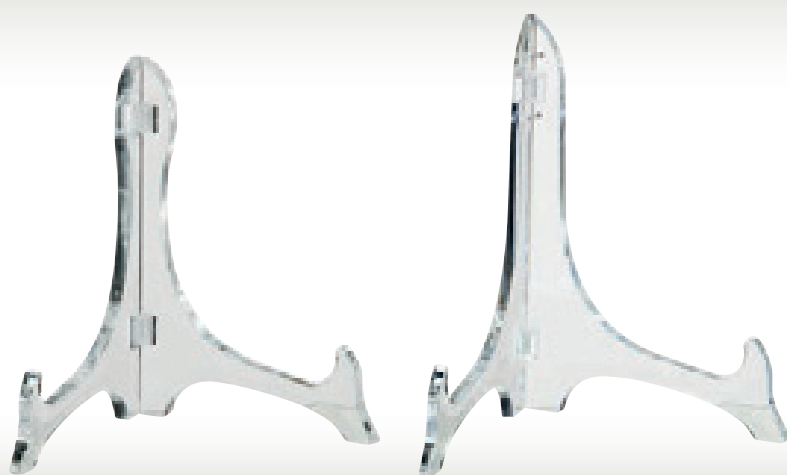

SPX - Supporto per targhe,
in metacrilato trasparente

SPX1 - h. 175 mm
SPX2 - h. 125 mm

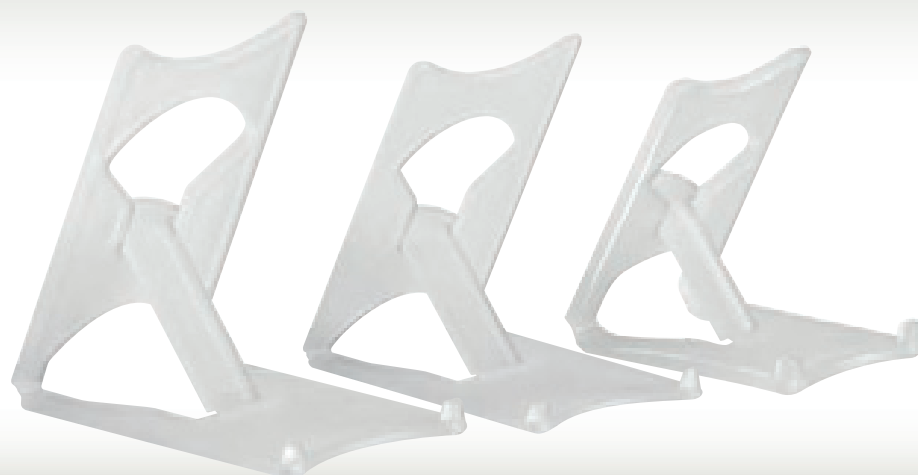

SAN - Supporto per targhe, in plastica

SAN1 - h. 90 mm
SAN2 - h. 70 mm
SAN3 - h. 50 mm

Supporti in metacrilato



AC - Accoppiato in metacrilato per disco, chiuso con piolini a cannocchiale avvitabili

AC10 - 155x155mm (per disco \varnothing 110 mm) Sp.10+5+10 mm

AC11 - 135x135mm (per disco \varnothing 90 mm) Sp.10+5+10 mm

AC12 - 115x115 mm (per disco \varnothing 70 mm) Sp.10+5+10 mm (con scatola in cartoncino con coperchio, disco non incluso)



PM - Supporto bifacciale in metacrilato per dischi

PM1 - 150x150 mm (per disco \varnothing 70 mm) Sp. 25 mm

PM2 - 115x115 mm (per disco \varnothing 50 mm) Sp. 25 mm (con scatola in cartoncino con coperchio, disco non incluso)



AC - Accoppiato in metacrilato per disco e targhetta, chiuso con piolini a cannocchiale avvitabili

AC20 - 180x210mm (per disco \varnothing 160 mm) Sp.15+6+8 mm

AC21 - 150x180mm (per disco \varnothing 140 mm) Sp.15+6+8 mm (con scatola in cartoncino con coperchio, targhetta inclusa, disco non incluso)

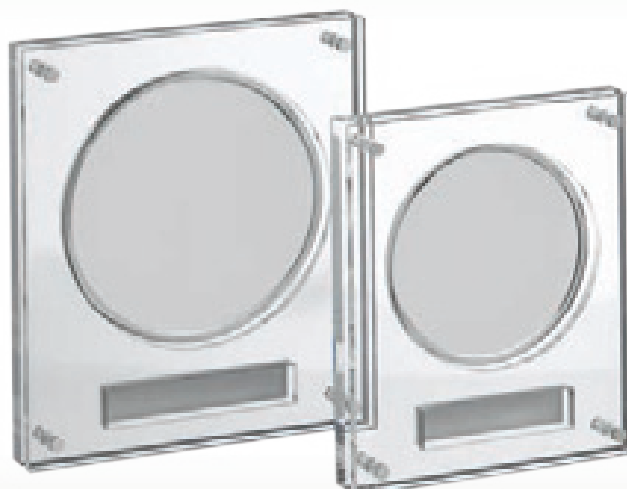

Supporti in metacrilato



CRPX - Supporto per targa scudo in metacrilato trasparente/fumé

CRPX1 - h. 260 mm Sp. 10-3 mm

CRPX2 - h. 240 mm Sp. 10-3 mm

CRPX3 - h. 220 mm Sp. 10-3 mm
(con scatola in cartoncino, targa non inclusa)



CAV - Supporto targa in metacrilato trasparente/sabbiato con piega

CAV1 - 245 x 200 + 100 mm Sp. 5 mm

CAV2 - 210 x 165 + 90 mm Sp. 5 mm

CAV3 - 175 x 140 + 75 mm Sp. 5 mm
(con scatola in cartoncino, targa non inclusa)



TV - Supporto targa in metacrilato trasparente/fumé con piega

TV1 - 220 x 170 + base

TV2 - 190 x 140 + base

TV3 - 160 x 120 + base

(con scatola in cartoncino, targa non inclusa)

Supporti in metacrilato



AC - Accoppiato in metacrilato trasparente/sabbiato per targa

AC01 - 255 x 205 mm Sp. 10+5+10 mm

AC02 - 220 x 170 mm Sp. 10+5+10 mm

AC03 - 185 x 145 mm Sp. 10+5+10 mm
(con scatola in cartoncino con coperchio, targa non inclusa)



PLS - Supporto in metacrilato per targa

PLS1 - 260 x 210

PLS2 - 230 x 180

PLS3 - 200 x 160

(con scatola in cartoncino, targa non inclusa)

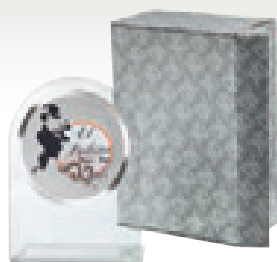

PD - Supporto in metacrilato per disco

PD1 - 192 x 270 mm + base

PD2 - 168 x 232 mm + base

PD3 - 132 x 182 mm + base

PD4 - 110 x 150 mm + base

PD5 - 85 x 120 mm + base

(con scatola in cartoncino, disco non incluso)



Trofei in metacrilato



DIS - Trofeo in metacrilato trasparente con base ad incastro

DIS1 - ø 190 mm

DIS2 - ø 165 mm

DIS3 - ø 130 mm
(con scatola in cartoncino)

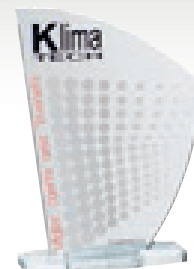

VEL - Trofeo in metacrilato trasparente con base ad incastro

VEL1 - h. 220 mm

VEL2 - h. 190 mm

VEL3 - h. 150 mm
(con scatola in cartoncino)



ONDA - Trofeo in metacrilato trasparente con base ad incastro

ONDA1 - h. 220 mm

ONDA2 - h. 190 mm

ONDA3 - h. 155 mm
(con scatola in cartoncino)



Ciondoli e medaglie

OSSO - Ciondolo in ottone satinato o cromato

OSSOC1 - acciaio satinato 55 x 25 Sp. 1 mm

OSSO1 - ottone satinato 55 x 25 Sp. 1 mm

OSSOC2 - acciaio satinato 40 x 20 Sp. 1 mm

OSSO2 - ottone satinato 40 x 20 Sp. 1 mm

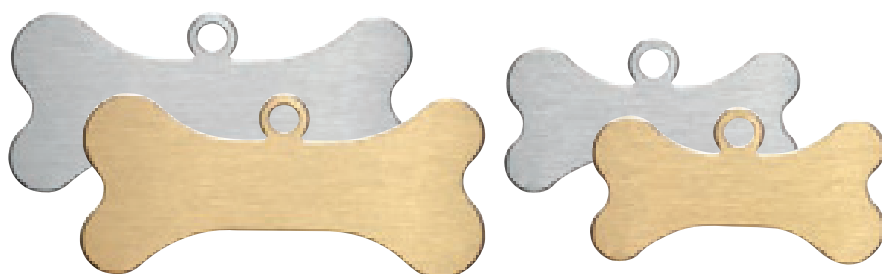

MED2 - Medaglietta in acciaio lucido con anellino

MED2 - ø 25 mm Sp. 1,5 mm



CAT1 - Catenella lunga, 660 mm

CAT2 - Catenella corta, 150 mm

GOM1 - Gommino per medaglia

MED1 - Medaglietta in acciaio
mm 27x48x0,6



Spille



Spille realizzate in ottone, acciaio o argento 925%. Diverse le finiture, come lucido o satinato, plane o con loghi e scritte a rilievo, incise e smaltate o con marcatura laser. Diverse le tipologie di attacco, con chiodino, spilla da balia o magnete.





Pin1

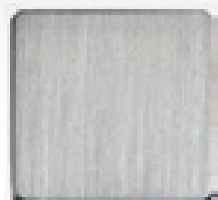

Pin2



Pin3



Pin4



Pin5

PIN1 - 18 x 18 mm Sp. 1 mm - Spilla quadrata con angoli arrotondati in ottone nichelato nero

PIN2 - 18 x 18 mm Sp. 1 mm - Spilla quadrata con angoli arrotondati in ottone silver satinato

PIN3 - ø20 mm Sp. 1 mm - Spilla tonda in ottone silver satinato

PIN4 - 16 x 20 mm Sp. 1 mm - Spilla scudo in ottone cromato

PIN5 - 16 x 20 mm Sp. 1 mm - Spilla scudo in ottone nichelato nero

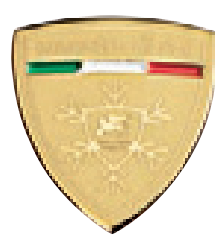
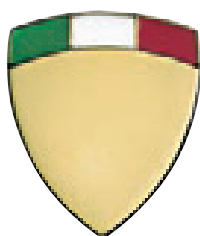

STE - Spilla in latta, grafica stampata su carta e plastificata

STE1 - ø 55 mm

STE2 - ø 37 mm



Trofei - Leoni



LEO - Leone in resina dorata
con base in metacrilato trasparente

LEO1 - h. 200mm base 260 x 125 x 20mm

LEO2 - h. 160 mm base 220 x 100 x 20mm

LEO3 - h. 120 mm base 165 x 75 x 20mm



LEOS - Leone in resina argentata
con base in metacrilato trasparente

LEOS1 - h. 200mm base 260 x 125 x 20mm

LEOS2 - h. 160 mm base 220 x 100 x 20mm

LEOS3 - h. 120 mm base 165 x 75 x 20mm

Trofei – Targhe premiazione

es. 401

Targa in ottone silver con bordo diamantato mm 250x150 con particolare e numero in ottone lucido applicati, stampa digitale. Montata su astuccio in velluto blu



es. 402

Targa in alluminio anodizzato argento mm 200x120 con bordo e riquadro lucidi, stampa digitale. Montata su astuccio in velluto blu



es. 403

Targhette in ottone, ottone silver, ottone brunito mm 100x100x3, con stampa digitale



es. 404

Cazzuole in ottone lucido e manico in legno lunghezza 105 e 85 mm



Trofei

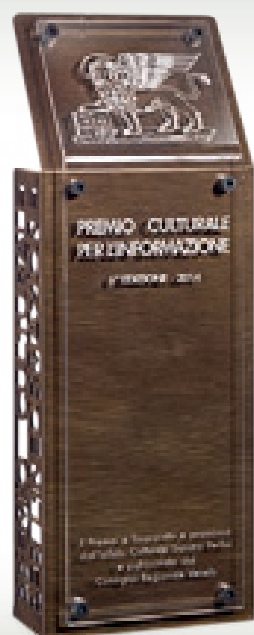

es. 405

Trofeo composto da piastra in ottone brunito piegato su tre lati con traforatura ai lati, piastra in metacrilato trasparente piegata e applicata con viti, incisione.
h. 335 mm



es. 406

Trofeo composto da alzata sagomata in metacrilato trasparente/sabbiato, dischi in ottone e ottone silver con stampa digitale, base in alluminio verniciato nero con targhetta in ottone silver.
h. 360 mm



es. 407

Trofeo composto da sagoma in metacrilato trasparente con applicato soggetto in ottone lucido, base in metacrilato trasparente.
h. 300 mm

es. 408

Trofeo composto da modellino automobile in fusione di ottone brunito, base in metacrilato trasparente con 3 righe incise e smaltate.
base 290 x 210 mm



es. 409

Trofeo composto da piastra in fusione di bronzo con ossidazione naturale e rilievi satinati, piastra in metacrilato sabbato sul retro, base in alluminio brunito.
h. 210 mm



es. 410

Trofeo composto da disco in alluminio fresato con inserto metacrilato, stampa digitale effetto carbonio, supporto in metacrilato sabbato e alluminio verniciato.
h. 280 mm



Trofei



es. 411

Trofeo composto da sagoma albero in metacrilato sabbato con applicati sul fronte e sul retro serpente in acciaio e ottone e mela in ottone. Base in legno MDF laccato e metacrilato trasparente con stampa digitale in vetrofania.
h. 335 mm



es. 412

Trofeo composto da modellino aereo in ottone fuso argentato, supporto in metacrilato sabbato, targhetta incisa e smaltata
h. metacrilato 270 mm



es. 413

Trofeo composto da piastra in alluminio verniciato e metacrilato trasparente, inserti logo e scritte in alluminio e incisione a laser sulla base.
h. 250 mm

es. 414

Trofeo composto da piastra in ottone brunito con marcatura laser, applicata su sagoma in metacrilato sabbiato. Base in metacrilato nero con rivestimento in ottone brunito sciolato h. 220 mm



es. 415

Trofeo composto da sagoma fiore in metacrilato trasparente Sp. 20 mm con stampa digitale e base in MDF verniciato nero h. 200 mm



es. 416

Trofeo composto da alzata in metacrilato trasparente con applicata piastra in metacrilato verniciato rosso con stampa digitale. Base in metacrilato trasparente. h. 150 mm, alzata Sp. 10 mm, base Sp. 15 mm





es. 417

Trofeo composto da sagoma in metacrilato trasparente con stampa digitale, base in metacrilato verniciato nero e trasparente. h. 185 mm



es. 418

Trofeo composto da sagoma in metacrilato trasparente con stampa digitale, sagoma in metacrilato colorato, base in alluminio nero e metacrilato trasparente. h. 290 mm



es. 419

Trofeo composto da alzata in metacrilato trasparente verniciato nero sul retro con stampa digitale. Base in metacrilato nero con stampa digitale. h. 250 mm

es. 420

Trofeo "Ciak" composto da alzata in metacrilato nero stampata con applicate barre stampate in bianco e nero con elemento in alluminio per apri-chiudi, sagoma pellicola in alluminio lucido/satinato e base in metacrilato nero.
h. 230 mm



es. 421

Targa in metacrilato trasparente con stampa digitale sul fronte e con applicato logo scontornato e targhetta in alluminio.
150 x 150 x 20 mm

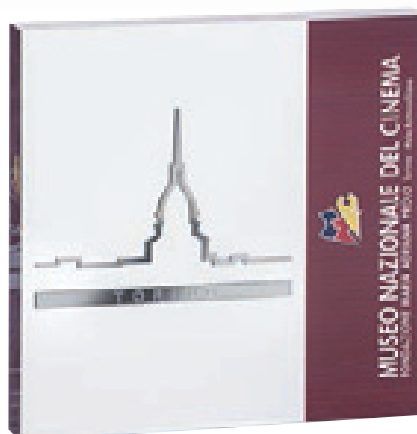

es. 422

Accoppiato in metacrilato trasparente con all'interno targa ottone argentato con marcatura laser e acidatura nero.
h. 150 mm



Trofei



es. 423

Trofeo "Golf" composto da sagoma in metacrilato sabbiato con applicato soggetto in alluminio lucido, pallina da golf in vetro, base metacrilato trasparente con stampa digitale sul fondo.
h. 260 mm



es. 424

Trofeo composto da piastra in metacrilato trasparente con stampa digitale e inserita nel tubo in metacrilato trasparente.
h. 230 mm



es. 425

Trofeo composto da alzata metacrilato trasparente sagoma bottiglie, con stampa digitale e base in metacrilato rosso.
h. 220 mm

Airone - ottone lucido dorato h. 270 mm

